



**WHITE KNIGHT™**

.....*simply driven™*

# AP200 DIMENSIONALS

## Pump Dimensions

DIMENSIONS IN [MILLIMETERS] INCHES

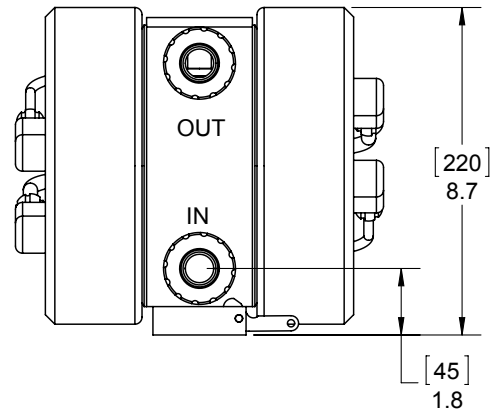
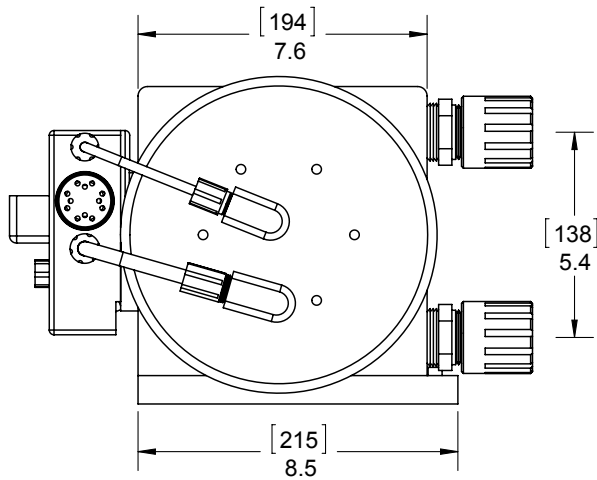
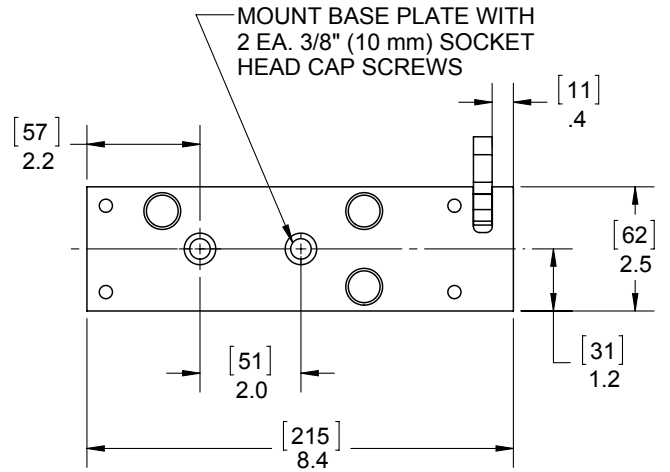
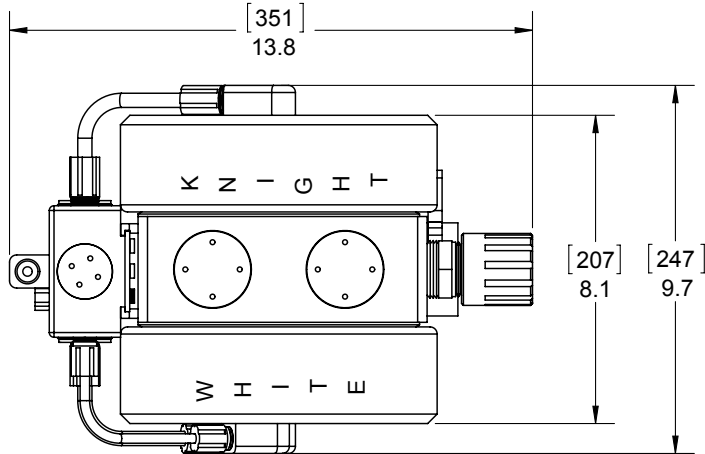

[wkfluidhandling.com/ap200](http://wkfluidhandling.com/ap200)

Our engineers are easy to work with and ready to perform your custom testing. Contact us at [info@wkfluidhandling.com](mailto:info@wkfluidhandling.com) or 435.783.6040, or visit [wkfluidhandling.com](http://wkfluidhandling.com)

Published July 17, 2013 | All specifications are subject to change without notice.

© 2013 White Knight Fluid Handling, Inc.

