

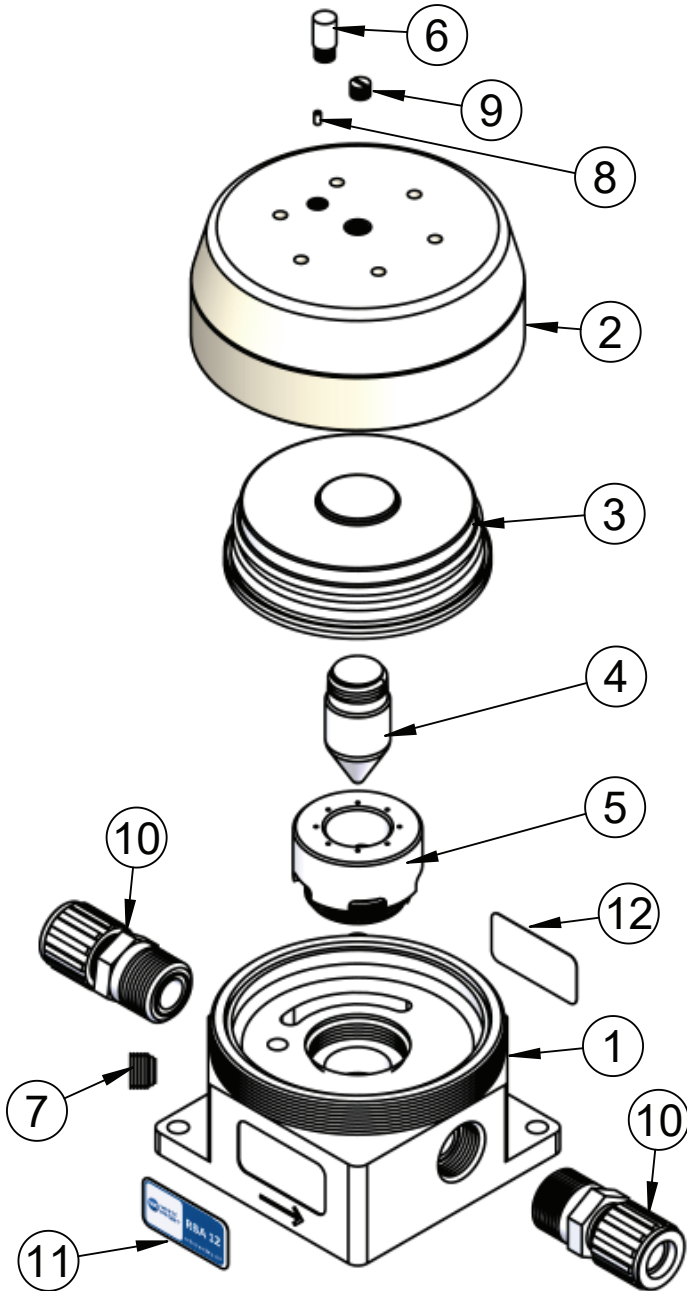





RBA12SL Exploded View

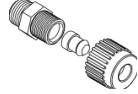

Item	Part Number	Description	Qty
1	1150-TE-0009	Body	1
2	2150-EP-0002	Head	1
3	3130-MP-0037	Bellows	1
4	4143-TE-0017	Piston-Sleeve	1
5	4144-TE-0007	Piston Sleeve	1
6	6110-PP-0003	Muffler 1/8-in Port (PP)	1
7	7130-TE-0006	1/4-in Fluid Port Plug	1
8	10020-PK-0002	Restrictor	1
9	10040-TE-0002	1/8-in NPT Plug	1
10	14510-PF-0005	3/4-in Flaretek Fittings	2
11	19100-PP-0052	Label	1
12	19100-PP-0120	CE Sticker	1

Fittings (Type, Size, Option)			Assemblies	Body Inlet Only (Nut not included)
 Flaretek Compatible	1/2 in.	F08	14510-PF-0004	7200-PF-0005
	3/4 in.	F12	14510-PF-0005	7200-PF-0006
	1 in.	F16	14510-PF-0006	7200-PF-0007
	1-1/4 in.	F20	14510-PF-0007	7200-PF-0008
 Tube Out	1/2 in.	T08	7120-PF-0004	
	3/4 in.	T12	7120-PF-0005	
	1 in.	T16	7120-PF-0006	
	1-1/4 in.	T20	7120-PF-0011	
 Weldable	3/4 in.	W12	7300-PF-0003	
	1 in.	W16	7300-PF-0004	
 Pillar S-300	3/8 in.	P06	14530-PF-0028	7400-TE-0036
	1/2 in.	P08	14530-PF-0003	7400-TE-0003
	3/4 in.	P12	14530-PF-0004	7400-TE-0004
	1 in.	P16	14530-PF-0005	7400-TE-0005
	1-1/4 in.	P20	14530-PF-0009	7400-TE-0012
 FNPT	1/2 in.	N08	7100-TE-0006	
	3/4 in.	N12	7100-TE-0004	
	1 in.	N16	7100-TE-0008	
 Synchro-Flare	1/2 in.	S08	14520-TE-0003	7010-TE-0005
	3/4 in.	S12	14520-TE-0004	7010-TE-0004
	1 in.	S16	14520-TE-0006	7010-TE-0006
PrimeLock	1/2 in.	L08	14570-PF-0003	7800-TE-0003
	3/4 in.	L12	14570-PF-0004	7800-TE-0004
	1 in.	L16	14570-PF-0005	7800-TE-0005
	1-1/4 in.	L20	14570-PF-0012	7800-TE-0012
Plugged		B00	7130-TE-0003	

<https://wkfluidhandling.com/pressure-regulators/>