





## ***DBA Series Installation Instructions***

---



# Installation and Precautions

## Precautions

<b>Liquid Inlet/Outlet</b>	
THESE LIQUID PORTS ARE NOT NPT OR ANY OTHER STANDARD. Attempting to use connectors other than those supplied by White Knight will damage the Dampener, and will void warranty.	
<b>Required Air Flow</b>	
Required air flow for all White Knight DBA series dampeners must match air supply to pump.	
<b>Operating a Pulsation Dampener with a White Knight Pump</b>	
When using a pulsation dampener with a White Knight pump the air operating pressure of the pump should be at least ten PSI higher than that of the liquid line. Failure to do so may cause the pump to run erratically.	
<b>Orientation</b>	
White Knight does not recommend installing your dampener in any position other than its upright position.	
<b>Cross Contamination</b>	
PTFE and many other plastics are very porous and may retain chemicals in the pores of the material. Record chemistries used in pumps and dampeners to avoid cross contamination.	
<b>WARNING: Liquids and Gasses Under Pressure</b>	
	While in a live system, pumps and dampeners contain pressurized liquids and gasses. All pressure, liquid and air must be eliminated via shut off valves before the pump or dampener may be removed or detached from the system.
<b>WARNING: Potential for High Surface Temperatures</b>	
	When dampeners are operated with high temperature fluids, heat may transfer to the exterior surfaces of the dampener. Avoid direct contact with the dampener when high temperature fluids are present.
<b>WARNING: Handling of Chemicals</b>	
	In the event that hazardous chemicals are used in or around the pump or dampener, ensure that appropriate personal protective equipment is used before handling. Reference the chemistry's Material Safety Data Sheet (MSDS) for handling instructions or other information specific to that chemical.
<b>WARNING: Noise Potential</b>	
	The exiting of exhaust air from the dampener will contribute to a work area's noise level. Always operate White Knight dampeners with the approved muffler media. When working in noisy conditions, use the necessary ear protection.

## System and Pump Environment Recommendations/Requirements

Clean Supply Air (CDA)
White Knight high purity dampeners require the use of class 2 air for particles and moisture per ISO 8573-1. (Maximum particle size 10 microns, -40° C dew point)
Location in System
Pulsation dampeners operate most effectively in close proximity to the pump. As such a dampener should be placed on the outlet line relatively close to the pump to maximize efficiency.
Flammable Solvents
White Knight high purity dampeners are not constructed from conductive materials. Any system used to pump flammable solvents should be properly grounded to avoid ignition by static charge. A test from River's Edge on using isolative pumps to pump flammable liquids indicated that the liquid itself must be grounded and that other procedures should be followed. A copy of the test is available upon request from White Knight.
Environmental Temperature
This product is rated to withstand environmental temperatures up to 50°C.

## Installation Advantages

Thermal Cycling
When operated within their respective temperature to pressure applications, White Knight DBA series dampeners require no maintenance even when used in thermal cycling applications.
Passing Solids
White Knight offers a complete line of pre-pump filters (White Knight Catcher™) to protect system components from debris that could damage the products.

## Installation Instructions (Top Mounted Configuration)

1.



- Remove top check plug using appropriate PVC pin wrench for Pump.

2.

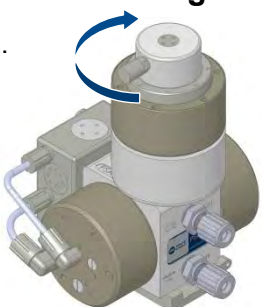

- Attach dampener to pump via top check plug port, tighten to:

Pump	in/LBS	kg/cm
030	50-60	57-69
060	65-75	75-86

3.

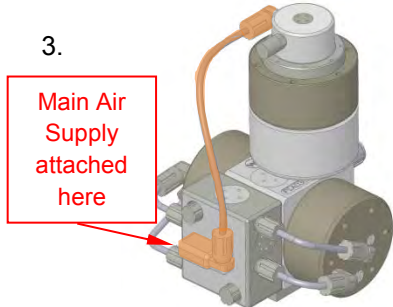

- Affix air supply following steps 8-12 in section 3.5.

Safety First
Pumps must be isolated from the system before servicing them for any reason, installing a pulse dampener included, to avoid the risk of chemical exposure.

## Installation Instructions (Inline Configuration)

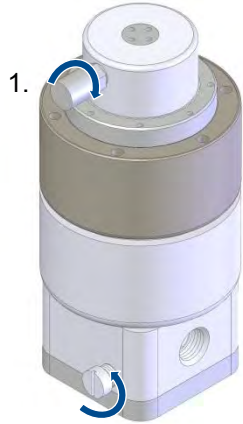

- Loosen lock screw on front of base and attach muffler.



- Slide base plate forward (dampener backward).

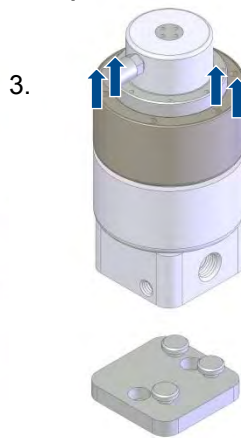

- Lift dampener off of base plate.

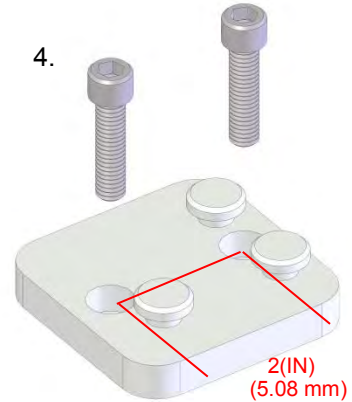

- Fix base plate to work station with  $\frac{3}{8}$ " or 10mm socket screws, screwed into pre-drilled/tapped holes.



- Place dampener onto mating base knobs. Slide dampener forward.



- Tighten lock screw on front of base. Attach muffler to  $\frac{1}{4}$ " NPT port on Air Motor.

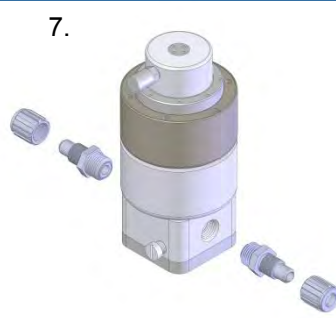

- Attach liquid fittings per manufacturer's instructions.

8. For air attachment with use of Solenoid valves see 9.1-9.3 on next page

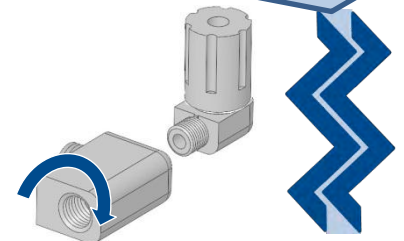

- Attach  $\frac{1}{8}$ " NPT elbow fitting to appropriate T fitting (T fitting must match pump air supply port,  $\frac{3}{8}$ " NPT for 140 LPM series pumps,  $\frac{1}{4}$ " NPT for 30 and 60 LPM series pumps)

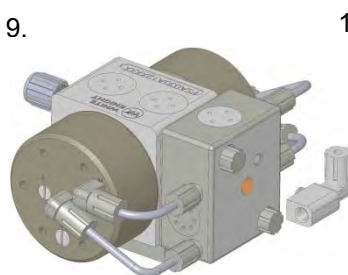

- Attach T fitting to pump air supply port.

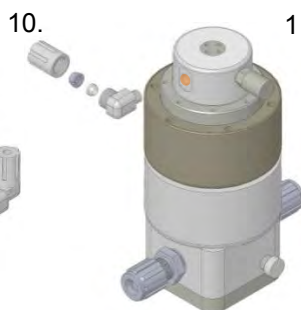

- Attach  $\frac{1}{8}$ " elbow to  $\frac{1}{8}$ " FNPT port on air motor of dampener.

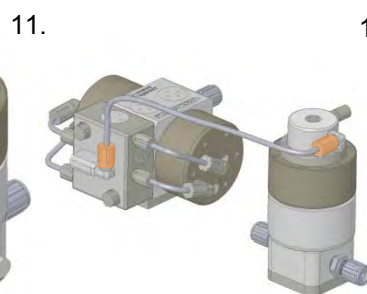

- Connect  $\frac{1}{4}$ " PFA tubing to both  $\frac{1}{8}$ " NPT elbows.

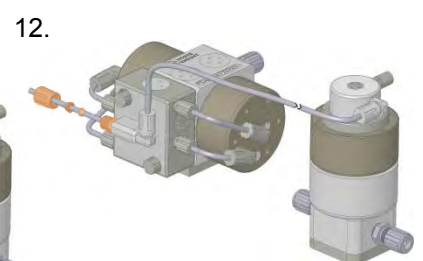

- Affix air supply to T fitting attached to pump.

### Liquid Inlet/Outlet

LIQUID PORTS TO DAMPENER ARE NOT NPT OR ANY OTHER STANDARD. Attempting to use connectors other than the ones supplied by White Knight will damage the dampener, and void the warranty



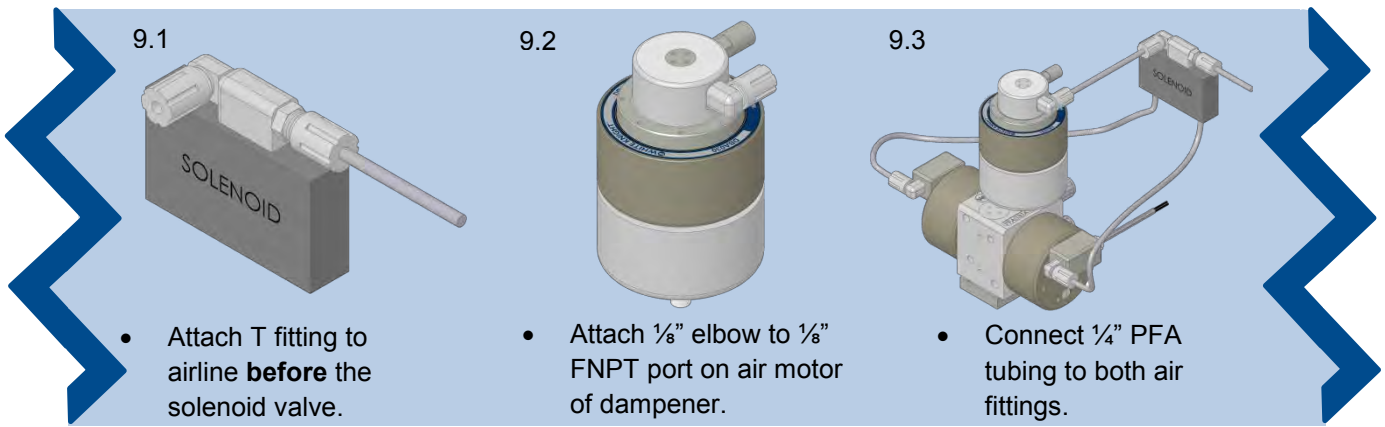

**Supply air to Dampener**

Air supply to the dampener must be shut off when air supply to the pump is shut off or the dampener may be damaged and the warranty voided.

## Fiber Optic Leak Detection

### Fiber Optic Leak Detection Attachment Instructions

**D10 amplifier must be calibrated before attaching fiber optic probe to the dampener. (See section 4.2)**

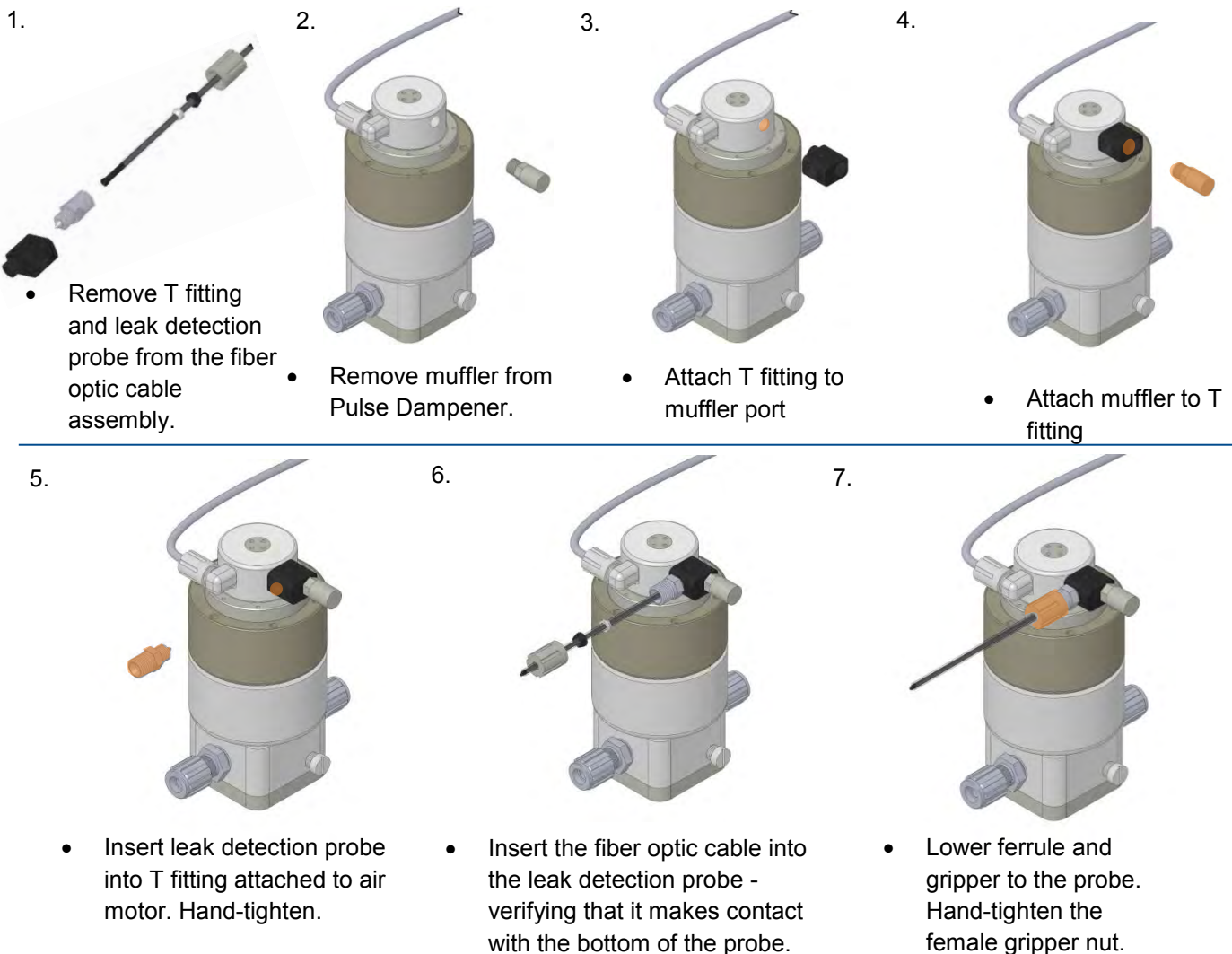



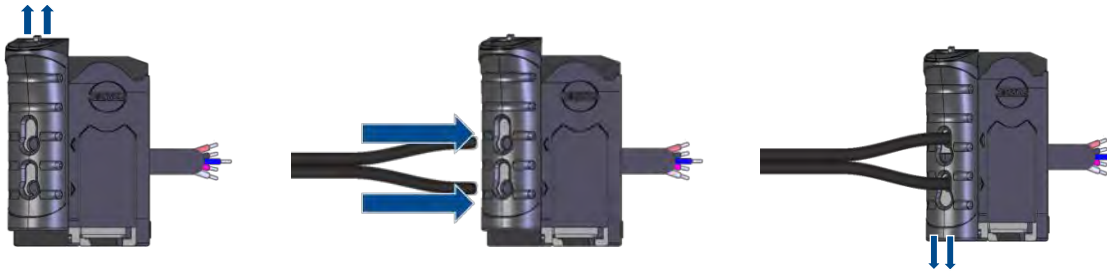



8.

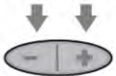
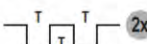

- Open the top and slide the front face of the D10 amplifier up. Press the fiber optic ends into the holes on the front face of the amplifier. Slide the face down to lock cables in place.

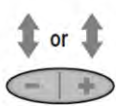
## Calibrating D10 Amplifier for Leak Detection

1. Powering up the D10 amplifier and ensure that the amplifier is set to “Dark Operate” mode.

	Push Button $0.04 \text{ seconds} \leq \text{“Click”} \leq 0.8 \text{ seconds}$	Remote Line $0.04 \text{ seconds} \leq T \leq 0.8 \text{ seconds}$	Result
Access SETUP Mode	<ul style="list-style-type: none"> <li>• Press and hold both push buttons &gt; 2 seconds.</li> </ul> 	<ul style="list-style-type: none"> <li>• Double-pulse remote line.</li> </ul> 	<ul style="list-style-type: none"> <li>• Green Power LED turns OFF.</li> <li>• Output LED remains active.</li> <li>• Icons continue to display current setup.</li> <li>• Bargraph turns OFF.</li> </ul> 
Select Setting Combination	<ul style="list-style-type: none"> <li>• Click either push button until LEDs show desired settings.</li> </ul> 	<ul style="list-style-type: none"> <li>• Pulse the remote line until LEDs show desired settings.</li> </ul>  <p>NOTE: Double-pulsing the remote line will cause the setting to “back up” one step.</p>	<p>Sensor toggles through eight setting combinations, in the following order:</p> <ul style="list-style-type: none"> <li>LO - Normal Speed - No Delay (default)</li> <li>DO - Normal Speed - No Delay</li> <li>LO - High Speed - No Delay</li> <li>DO - High Speed - No Delay</li> <li>LO - Normal Speed - Delay</li> <li>DO - Normal Speed - Delay</li> <li>LO - High Speed - Delay</li> <li>DO - High Speed - Delay</li> </ul>
Return to RUN Mode	<ul style="list-style-type: none"> <li>• Press and hold both push buttons &gt; 2 seconds.</li> </ul> 	<ul style="list-style-type: none"> <li>• Hold remote line low &gt; 2 seconds.</li> </ul> 	<ul style="list-style-type: none"> <li>• Green Power LED turns ON.</li> <li>• Sensor returns to RUN mode with new settings.</li> </ul> 

2. Access “Single-Point Dark Set” mode.

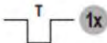
	Push Button $0.04 \text{ seconds} \leq \text{“Click”} \leq 0.8 \text{ seconds}$	Remote Line $0.04 \text{ seconds} \leq T \leq 0.8 \text{ seconds}$	Result
Access SET Mode	<ul style="list-style-type: none"> <li>• Press and hold Static push button &gt; 2 seconds</li> </ul> 	<ul style="list-style-type: none"> <li>• Single-pulse remote line</li> </ul> 	<p>Power LED: OFF Output LED: ON (push button)                   OFF (remote line) Static LEDs: LO &amp; DO alternately flashing</p> 