



# **PFH030 Installation Instructions**



## **Table of Contents**

<b>1. Owner's Manual</b>	<b>1</b>
<b>2. Installation</b>	<b>2</b>
2.1 Precautions .....	2
2.2 Warnings .....	3
2.3 Advantages .....	3
2.4 Environment & System.....	3
2.5 Installation Instructions.....	4
<b>3. Control &amp; Monitoring</b>	<b>5</b>
3.1 Shift Logic for Fiber-optic Pumps .....	6
3.2 Fiber Optic Stroke Detection Installation.....	7
3.3 Calibrating D10 Amplifier for Stroke Detection.....	7
3.4 Fiber Optic Leak Detection Installation .....	8
3.5 Calibrating D10 Amplifier for Leak Detection .....	9

## **1. Owner's Manual**

Available online: <https://wkfluidhandling.com/manuals/>

The Installation Instructions provided in this document are available in the PFH030 Owner's Manual, version 2.0.0, published 8/26/2016.





## 2. Installation

### 2.1 Precautions

#### Handling

Do NOT lift pump by fiber optic cables, quick exhaust valves nor air tubing.

#### Installation Orientation

PFH030 pumps must be installed in an upright position. The check valves are actuated by gravity and/or flow, and they will not seat if the pump is not upright.

#### Timer Mode

PFH030 pumps require an end of stroke detection mechanism (pressure switch) to prevent over stroking in timer mode. Operating a PFH030 in timer mode without stroke detection will void the pump warranty.

#### Required Air Flow (Shuttle Valve)

PFH030 pumps require 1/4 in minimum orifice with unrestricted air flow.

#### Required Air Flow (Solenoid Valve)

PFH030 pumps require a 0.75 Cv solenoid. Using a reduced Cv will reduce flow rates. Using a valve with more than 20% greater Cv will change operating parameters, reduce pump life and void the warranty.

#### Under Supply of Air

PFH030 pumps operate erratically or stall when air supply is insufficient. Ensure use of air supply pressures higher than averaged air consumption lines in performance charts. Air supply lines and fittings must meet minimal inner diameter requirements shown in the installation instructions.

#### Air Supply Pressure

Operating PFH030 pumps ~35% below max air pressure may significantly extend pump life. PFH030 pumps require 20 psi minimum air pressure. Operation above 5.5 bar (80 psi) may damage the pump and void the warranty.

#### Suction Lift

PFH030 pumps have an initial suction lift capacity of 3 ft. For best results minimize suction lift.

#### Liquid Inlet/Outlet Connections

PFH030 liquid ports are not NPT nor any other standard. Use of connectors other than those supplied by White Knight will damage the pump and void the warranty.

#### Liquid Line Restriction

PFH030 pumps may be controlled by closing liquid outlet lines. However, restricting liquid supply lines increases wear and should be avoided. Do NOT pump against a closed liquid inlet. It will damage the pump and void the warranty.

#### Running Dry

PFH030 pumps use the pumped liquid to lubricate their shafts. The pumps will cycle faster and wear more than normal when run dry, which may cause damage and loss of self-prime abilities. Standard models should not be run dry after start-up and are not warranted under dry run conditions. Dry-run capable PFHSD030 models may run dry for short periods. Warranty of dry-run models is one-year. Extended warranties are available.

#### Pulse Dampener with Shuttle Valve

Air supply pressure to PFH030 pumps should be at least ten psi higher than the liquid line pressure when using a pulsation dampener. Failure to do so may cause erratic operation.

#### Cross Contamination

PFH030 pumps use porous material that may retain chemicals. Take precautions to avoid cross contamination.



## 2.2 Warnings

### Pressurized Material



Pumps in use contain pressurized materials. Eliminate liquid and air pressure via shut off valves before pump is detached or removed from the system.

### High Temperature



Heat may transfer to exterior surfaces when pumps operate with high temperature fluids. Avoid direct contact with the pump when high temperature fluids are present.

### Hazardous Chemical



Use appropriate personal protective equipment when handling pump. Reference Material Safety Data Sheet (MSDS) for information specific to your chemicals.

### Loud Noise



Pump exhaust air contributes to work area noise levels. Only operate pumps with approved muffler media, and use ear protection in noisy conditions.

## 2.3 Advantages

### Head Pressure / Dead-Head

PFH030 pumps can be controlled by adjusting their liquid outlet pressures and can be installed with head pressures up to dead-head (e.g. equal liquid and air pressures) with no damage to the pump.

### Thermal Cycling

PFH030 pumps require no maintenance when operated within their performance range, even in thermal cycling applications.

## 2.4 Environment & System

### Oversized Inlet Line

Pumps operate optimally with liquid inlet lines larger than the liquid outlet lines. This reduces strain on the bellows and may reduce pulsation in the pump outlet.

### Clean Supply Air (CDA)

PFH030 pumps require use of Class 2 air for particles and moisture per ISO 8573-1. Use 10 micron filter; maintain -40°C dew point. A point-of-use filter is recommended during first six months of operation in new fabs/systems due to high risks of debris that can damage pumps and void warranty.

### Flammable Solvents

PFH030 pumps are not constructed from conductive materials. System that pump flammable solvents should be properly grounded to avoid ignition by static charge. A River's Edge test of isolative pumps with flammable liquids indicated that liquids must be grounded and other procedures should be followed. Copy of test available.

### Pumping Liquids Near Boiling Point

Minimizing suction lift reduces pulsation and the potential for boiling or outgassing of liquid in the inlet of the pump. Although reciprocating pumps can pull suction lift, pump performance and life increase when suction lift is minimized or eliminated.

### Abrasive Slurry

Pumping abrasive slurry shortens the life of any pump. PFH030 pumps are warranted when used in abrasive applications. However, wear of components will be accelerated. Normal wear is not a condition covered by warranty.

### Environmental Temperature

PFH030 pumps are rated to withstand environmental temperatures up to 50°C.



D10 amplifier must be calibrated before attaching fiber optic probes to the pump.

### 2.5 Installation Instructions

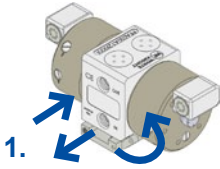

**1.** Set lever to up position. Slide base plate forward or pump body backward.

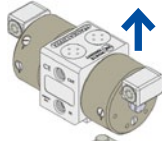

**2.** Lift pump off of base plate.

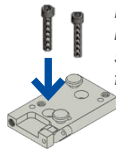

**3.** Screw base plate to surface with 3/8 in or 10 mm head cap socket screws into pre-drilled holes.

*Pull-back dismount is standard. See steps 3.1-3.3 for forward dismount.*

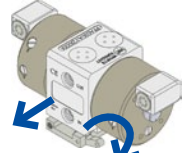

**4.** Set pump on base knobs; slide it forward. Set lever to down position.

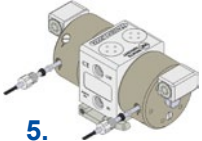

**5.** Insert fiber-optics fully into heads. Push in ferrule and gripper; hand-tighten nut.

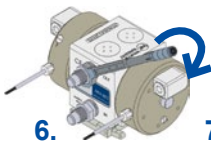

**6.** Attach fittings to pump. Tighten to 30 inch-lbs.

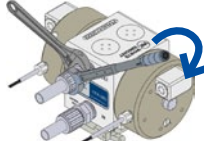

**7.** Attach tubes and fittings per manufacturer instructions. Use backer wrench to hold fittings in place at pump.

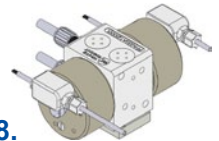

**8.** Set air line via 1/4 in FNPT ports on quick exhaust valves. Line must be 3/16 in minimum orifice.

#### Push-Forward Dismount Configuration Setup

Replace step 4 with steps 3.1-3.3 to re-configure the base plate to push-forward dismount.

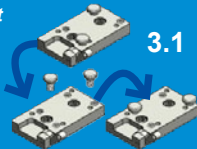

**3.1** Move knobs to opposite sides.

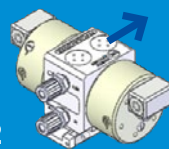

**3.2** Set pump on base knobs; slide it backward.

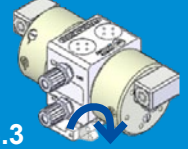

**3.3** Move lever down to locked position.

#### Install with Rigid Base Plate

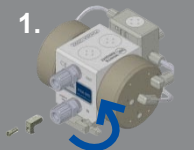

**1.** Remove L bracket. Set lever in neutral (up) position.

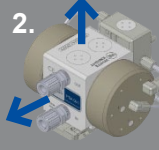

**2.** Slide pump forward; lift it off base plate.

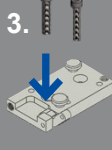

**3.** Fix base plate to work station. See step 4 above.

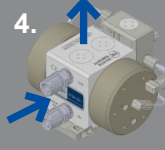

**4.** Return pump to base plate.



**5.** Move lock lever to down position. Reattach L bracket. Tighten hand tight.

#### Liquid Inlet/Outlet

Liquid ports are not NPT nor any other standard. Use of connectors other than those supplied by White Knight will damage the pump.





### 3. Control & Monitoring

#### Programmable Control

White Knight CPT-1 controllers monitor and adjust run mode, flow rate, leak detection and other pump operations.



#### D10 Amplifier Electrical Hookups & Dimensions

White Knight recommends Expert™ D10 amplifier for use with fiber optic stroke and leak detection assemblies.

##### Standard Models and Main Unit

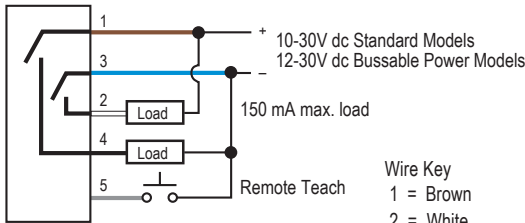

- Wire Key  
 1 = Brown  
 2 = White  
 3 = Blue  
 4 = Black  
 5 = Gray

QD hookup is functionally identical (Pink wire not used)

##### Sub-Units

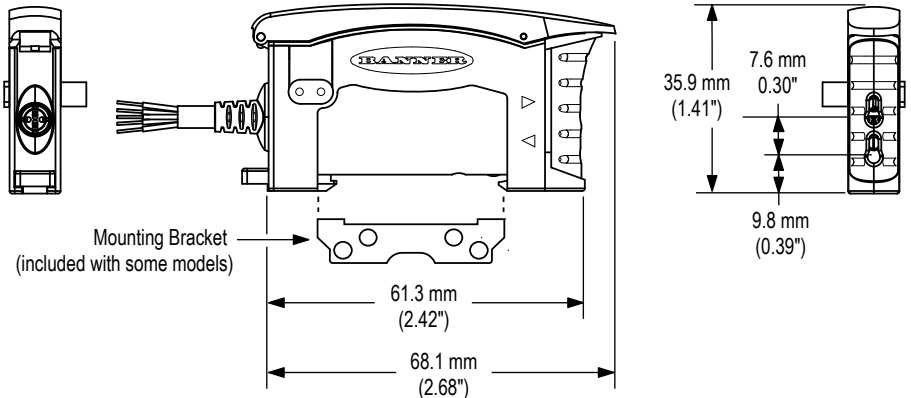
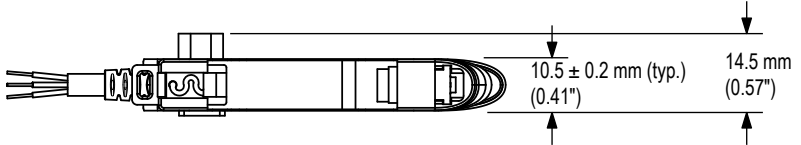
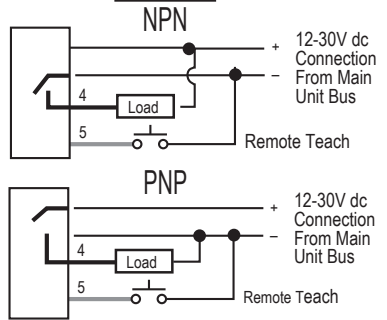



### 3.1 Shift Logic for Fiber-optic Pumps

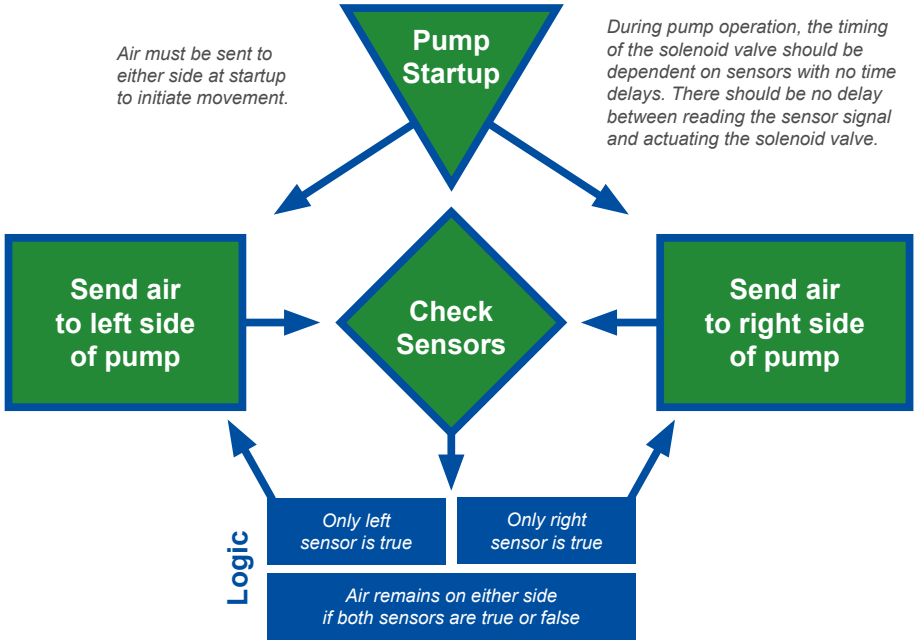



### 3.2 Fiber Optic Stroke Detection Installation

For standard end stroke, follow steps for both sides of the pump.

For single-probe dual-detect, follow steps for only the left side.

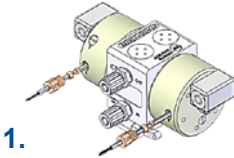

**1.** Insert fiber optic probes fully into heads. Push in ferrule and gripper; hand-tighten nut.

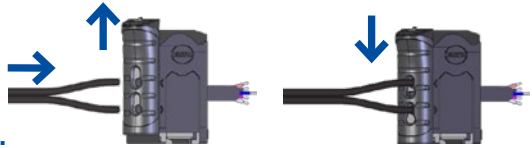

**2.** Open the top and slide the front face of the D10 up. Press the fiber optic ends into the holes on its front. Slide the face down to lock cables in place.

### 3.3 Calibrating D10 Amplifier for Stroke Detection

When calibrating the D10 Amplifier for stroke detection, the pump should be in the same operating conditions it will be in during normal operation (i.e. supply air pressure, back pressure, etc.). The Fiber Optic must be installed as per the instructions in section 3.1.

Calibration:			
	Push Button	Remote Line	Result
<b>Access Dynamic TEACH Mode</b>	Press and hold dynamic push button >2 seconds.	Hold Remote line low (to ground) >2 Seconds.	<ul style="list-style-type: none"> <li>Power LED: OFF</li> <li>Output LED: OFF</li> <li>Bar graph: LO &amp; DO Alternately Flashing</li> </ul>
<b>TEACH Sensing Conditions</b>	<ul style="list-style-type: none"> <li>Hold push button.</li> <li>Operate pump normally for 15 seconds.</li> </ul>	<ul style="list-style-type: none"> <li>Hold remote line low (to ground).</li> <li>Operate pump normally for 15 seconds.</li> </ul>	<ul style="list-style-type: none"> <li>Power LED: OFF</li> <li>Output LED: OFF</li> <li>Bar graph: LO &amp; DO Alternately Flashing</li> </ul>
<b>Return to Run Mode</b>	Release button	Release remote line/switch	Teach Accepted Power LED: ON Bar graph: One LED flashes to show relative contrast (successful setup requires minimum value of 4). Sensor returns to Run Mode with new settings.
			Teach Unaccepted Power LED: OFF Bar graph: #1, 3, 5, 7 alternately flash to show failure to sense. Sensor returns to Run mode without changing settings. Set up again if value shows <4.

Upon completion of a successful learning cycle, the D10 Amplifier will continuously learn and self-teach to maintain the same cycle rate count readings.





### 3.4 Fiber Optic Leak Detection Installation

D10 amplifier must be calibrated before attaching fiber optic probes to the pump.



**1.** For elbow out configuration, replace steps 2-4 with steps 2.1-2.4 (below).

Remove leak adapter and leak detect probe from fiber optic assembly.

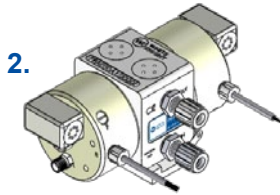

**2.** For straight out configuration replace NPT plug in "L" port with the probe. Hand-tighten.

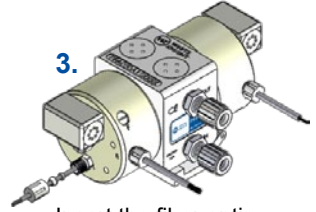

**3.** Insert the fiber optic cable until it contacts the bottom of the probe.

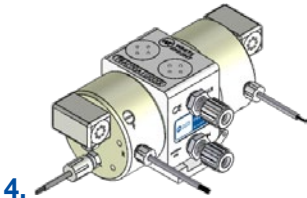

**4.** Lower ferrule and gripper until snug against probe and hand tighten female gripper nut.

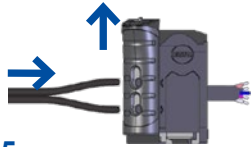

**5.** Open the top and slide the front face of the D10 up. Press the fiber optic ends into the holes on its front. Slide the face down to lock cables in place.

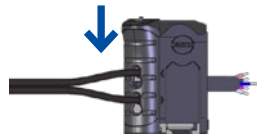

For elbow out configuration:

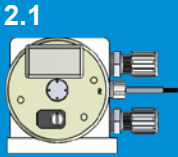

**2.1**  
Replace NPT plug in "L" port with the leak adapter.

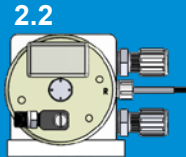

**2.2**  
Attach probe to leak adapter and hand-tighten.

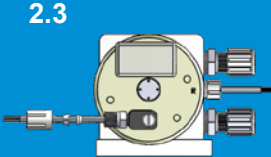

**2.3**  
Insert fiber optic cable into leak detect probe, ensure it contacts the bottom of the probe.

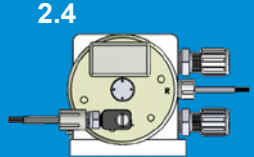

**2.4**  
Lower ferrule and gripper into the probe. Hand-tighten female gripper nut.







### 3.5 Calibrating D10 Amplifier for Leak Detection

#### Step 1: Power On D10 Amplifier & Set "Dark Operate" Mode:

	Push Button <i>0.04 s ≤ "Click" ≤ 0.8 s</i>	Remote Line <i>0.04 s ≤ T ≤ 0.8 s</i>	Result
<b>Access Setup Mode</b>	Press and hold both buttons > 2 seconds. 	Double-pulse remote line 	<ul style="list-style-type: none"> <li>Green Power LED turns OFF.</li> <li>Output LED remains active.</li> <li>Icons continue to display current setup.</li> <li>Bargraph turns OFF.</li> </ul>
<b>Select Settings</b>	Press either button until LEDs show desired settings. 	Pulse the remote line until LEDs show desired settings.  Note: Double-pulsing remote line causes setting to "back up" one step.	Sensor toggles through these setting combinations: LO - Normal Speed - No Delay (default) DO - Normal Speed - No Delay LO - High Speed - No Delay DO - High Speed - No Delay LO - Normal Speed - Delay DO - Normal Speed - Delay LO - High Speed - Delay DO - High Speed - Delay
<b>Return to Run Mode</b>	Press and hold both buttons > 2 seconds. 	Hold remote line low > 2 seconds. 	<ul style="list-style-type: none"> <li>Green Power LED turns ON.</li> <li>Sensor returns to Run mode with new settings.</li> </ul>

#### Step 2: Access "Single-Point Dark Set" Mode

	Push Button <i>0.04 s ≤ "Click" ≤ 0.8 s</i>	Remote Line <i>0.04 s ≤ T ≤ 0.8 s</i>	Result
<b>Access Set Mode</b>	Press and hold static button > 2 seconds. 	Single-pulse remote line 	<ul style="list-style-type: none"> <li>Power LED: OFF.</li> <li>Output LED: ON (push button) OFF (remote line)</li> <li>Static LEDs: LO &amp; DO alternately flashing</li> </ul>

#### Step 3: Set Sensing Condition

Set condition to "leak detection" sensing while probe tip is submerged in liquid. Then, remove the leak probe from liquid and reinserted into the "L" port. Amplifier will now signal when moisture is detected on the probe tip.

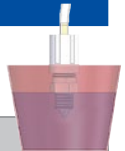

	Push Button <i>0.04 s ≤ "Click" ≤ 0.8 s</i>	Remote Line <i>0.04 s ≤ T ≤ 0.8 s</i>	Result
<b>Set Sensing Condition</b>	<ul style="list-style-type: none"> <li>Present sensing condition</li> <li>Five-click static button</li> </ul>	Present sensing condition • Five-pulse remote line 	<ul style="list-style-type: none"> <li>Power LED: ON.</li> <li>Output LED: ON (push button) OFF (remote line)</li> <li>Bargraph: 4 indicators flash.</li> <li>Sensor returns to Run mode with new settings</li> </ul> <ul style="list-style-type: none"> <li>Power LED: ON.</li> <li>Output LED: ON (push button) OFF (remote line)</li> <li>Bargraph: #1, 3, 5, 7 flash for failure.</li> <li>Sensor returns to Set sensing condition.</li> </ul>

