

IMTEC



ACCUHEAT®

Streamline

SINGLE TUBE IN-LINE HEATERS

INSTRUCTION MANUAL

PART NUMBER 10-018-0039

CE

IMTEC Acculine

49036 Milmont Drive
Fremont, CA 94538
Telephone: (510) 770-1800
Fax: (510) 770-1400

*On the Web at: www.imtecacculine.com
Email: imtecc@imtecacculine.com*

COPYRIGHT© 2015 IMTEC

All rights reserved. Any reprinting or unauthorized use without the written permission of IMTEC is expressly prohibited.

This document contains proprietary information of IMTEC and is tendered subject to the conditions that the information:

- be retained in confidence,
- not be reproduced or copied in whole or in part, and
- not be used or incorporated as part of any product, except under an express written agreement with IMTEC

All information in this document is subject to change without notice.

The information in this manual has been carefully checked and is believed to be accurate; however, no responsibility is assumed for inaccuracies or omissions.

References in this manual may describe optional equipment. Please contact an IMTEC sales representative for information about standard and optional equipment.

Manual Part Number:	10-018-0039
Release Date:	06/5/2014

Instruction Manual Revision History

Date	Section	Description
6/20/2014	Entire Manual	Initial release of Accuheat Streamline Series manual. Released new manual part number.
2/20/15	Section 4	Clarified descriptions relating to pins 6 and 7 of Power Modulator
10/28/15	Sections 1,3,4,6	Added information on Imtec Fit-One Buttress thread nut
7/19/16	Numerous	Deleted any reference to Inc. or LLC at this time throughout manual

THIS PAGE INTENTIONALLY LEFT BLANK.

PREFACE

This preface includes the following topics:

- intended use and audience
- basic safety considerations
- customer support
- conventions used in this manual
- how this manual is organized
- standard IMTEC Accuheat warranty
- table of contents

CAUTION



USING IMPROPER CONFIGURATION VALUES CAN CAUSE PRODUCT OR EQUIPMENT DAMAGE

Do not enter set-up or configuration values outside the specified range for any given heater or optional device. To do so may seriously damage your product or equipment.

Intended Use of this Equipment

IMTEC's Single Tube Heater Accuheat Systems are not to be used for any purpose other than for which they were designed. What product is to be produced and how the heater and any optional equipment are to be configured for the allowed processing chemicals and parameters are stated in this Instructions Manual.

Intended Audience

The level of detail in this manual assumes you have previously been trained to install, operate and maintain these systems.

This document supplements that training and addresses the comprehensive needs of Process Engineers and Maintenance personnel. After reading and understanding this information, Process Engineers are responsible for disseminating the appropriate level of information to their Equipment Operators.

Safety Considerations

Your company's policies and procedures for safely operating any of the Single Tube Accuheat Systems supersede the safety considerations listed below. It is your responsibility to follow your company's safety procedures. If there are none, follow those established by OSHA, NEC, DEQ, and/or the DOT, as a minimum.

Environmental Information

The following laws and regulations are applicable to the operation and maintenance of IMTEC's Single Tube Accuheat Systems.

- Air Emissions are regulated under the US Clean Air Act and local regulations applicable to the emissions of acids, bases and organic compounds.
- Wastewater emissions are regulated under the US Clean Water Act and applicable local pretreatment regulations.
- Solids contaminated with acids and other chemicals are regulated as hazardous wastes.

General Safety

- Never open or disassemble the heater tube. There are no serviceable parts inside the tube.
- Do not attempt to work on or with hazardous chemicals or electrical equipment without proper safety training and certification, and personal protective equipment.
- Lockout and tag the electrical and/or chemical systems before any repair or replacement tasks. Refer to this Instructions Manual for this equipment and your company's safety policies and procedures for repair instructions.
- Before attempting any procedures, know how to perform emergency first aid response for electrical shock and spills of hazardous chemicals.
- Review & understand emergency escape routes to safe areas.

Electrical Safety

- During periods of lightning activity, do not connect or disconnect any cables or perform installation, maintenance, or reconfiguration.
- Before attempting any procedures, locate the main electrical source and understand how to safely control it.
- Whenever possible, disengage the heater and optional devices from their electrical sources before attempting repairs.
- Notify nearby personnel that you are attempting to operate or service this equipment. Follow your company's lockout and tagout operating procedures.

Chemical Safety

- Never attempt operations or repairs involving hazardous chemicals alone. Always have another person within sight and voice range.

- Protect eyes, face, hands, and body with appropriate personal protective equipment.

Before Powering Up the Heater

- Understand the system's alarm indications and automatic system interlocks (refer to Section 2, *Safety Requirements*).
- Ensure that all safety devices in the work area are properly installed and functional.

Cleanroom Requirements

Specific cleanroom requirements can vary widely according to the class rating, i.e., Class 10, Class 100, etc. IMTEC's products qualify as Class 1. While performing maintenance or operating the system, follow your company's policies and procedures for this equipment.

Customer Support

In the case of emergency or equipment failure, refer to the **Emergency Contact Form** (under separate cover).

For assistance in operating, troubleshooting, or maintaining your heater, refer first to this and any other manuals supplied to you by IMTEC. If these manuals do not address your specific question, please contact IMTEC Customer Service:

<p>IMTEC Acculine 49036 Milmont Drive Fremont, CA 94538</p>	<p>Phone: (510) 770-1800 Fax: (510) 770-1400</p>
<p>Email: imtec@imteccaculine.com</p>	<p>From 8:00 a.m. to 5:00 p.m., PST, Monday through Friday</p>

When calling, please be at the system, if possible, and be prepared to give a detailed description of the problem.

Customer (EHS) Contact Information

In the event that IMTEC needs to contact the customer regarding EHS issues related to the Accuheat In-line heater, they will use the contact provided on the Purchase Order or that provided on a returned warranty registration card. In the event the equipment is moved to a different location you can send new contact information via mail to Imtec's address above. Please note company name, address, product serial number, and contact information.

NOTE



Review your contract warranty statements regarding specific instructions for receiving help.

Preventive Maintenance

Other than a weekly visual inspection for leaking connections, there are no preventive maintenance schedules or procedures.

Conventions Used In This Manual

1. The word “WARNING” when used in warning boxes is defined as: **IMPROPER USE OF THIS EQUIPMENT CAN CAUSE SEVERE INJURY OR PRODUCT DAMAGE!**
2. The word “CAUTION” when used in warning boxes is defined as, **POTENTIAL PRODUCT OR EQUIPMENT DAMAGE!**
3. The following **WARNING** and **CAUTION** boxes are samples used to identify potential hazards that could occur if the heater is used improperly or if unsafe practices are followed.

WARNING		
	<p>IMPROPER USE OF THIS EQUIPMENT CAN CAUSE SEVERE INJURY OR PRODUCT DAMAGE!</p> <p>To ensure operator, equipment, and product safety, follow the instructions and use care when operating this equipment.</p>	

CAUTION	
	<p>POTENTIAL PRODUCT OR EQUIPMENT DAMAGE!</p> <p>Equipment or product damage can occur if care is not taken.</p>

A **NOTE** box highlights special information.

NOTE
<p>Specific information is placed in a NOTE box when clear procedural understanding is essential.</p>

The following conventions are used throughout the manual:

Data entries on pictured control screens or menus. Unless stated otherwise, all example values on pictured data entry screens are for display purposes only and were not intended to be considered as recommended values for your equipment.

Boldface text indicates the actual words used in a screen command or on an equipment label.

How To Use This Manual

The level of detail in this manual, and listed below, covers the necessary information to install, operate, maintain, and service Single Tube Accuheat Systems.

Instruction Manual Revision History Page: details any changes made to the manual, the date the change took place, and what specific information was changed, added or deleted. If changes or updates are added to your individual manual, a new Revision History Page will be sent to you along with those changes.

Preface, includes the intended use and audience, basic safety considerations, customer support, conventions used in this manual, how this manual is organized, standard IMTEC Accuheat warranty, and a table of contents.

Section 1, *Introduction*, is a description of the various models for the Accuheat Single Tube Systems including: a theory of operations, specifications, and facility requirements.

Section 2, *Safety Requirements*, is a detailed description of all safety features and their functions and interactions.

Section 3, *Unpacking Procedures*, lists the procedures for inspecting and unpacking the Accuheat Single Tube Systems and optional equipment.

Section 4, *Installation Procedures*, included is a set of drawings indicating the connections to be made specific to your system.

Section 5, *Operating Instructions*, gives instructions on how to operate the heater and optional equipment after installation.

Section 6, *Troubleshooting and Maintenance Procedures*, covers typical troubleshooting techniques, maintenance schedule and procedures. If the heater needs to be returned for servicing this section give instructions for removing the heater for preparation for repair.

Updates. In the event new information is required, such as, corrections or updates after shipment of this documentation, IMTEC will send this new information to you. Upon initial shipment of this manual this section will be empty.

Accuheat In-Line Heater Limited Warranty – (Non-Warranty of Merchantability, Fitness and Limitation of Liability)

Terms and Conditions

1. IMTEC warrants the Accuheat In-Line Heater, whether new or remanufactured, to be free from manufacturing defects in materials and workmanship for a period of **two years** from the date of original shipment from our factory, with the following exceptions:
 - **Failures caused by chemical etching of the quartz tube are not covered under warranty.**
 - **Failures due to not using the Imtec Power Modulator or system with same functionality are not covered under warranty**
 - IMTEC quartz ware is guaranteed to remain sound and whole in normal usage for a period of 45 days from the date of initial shipment.

NOTE

“Remanufactured” applies to the complete rebuilding of a customer-owned Accuheat unit to new in-line heater specifications, including heaters, cable attachments, insulation and the like.

2. This Warranty, with the exception noted above, is limited as follows: In the event of a defect, IMTEC agrees, at its option, to repair or replace the defective unit or refund the purchase price and IMTEC’s liability is limited thereto. Heaters repaired or replaced under warranty will bear the remainder of the original equipment warranty.
3. All repairs must be made at IMTEC’s place of business. Buyer pays the cost of returning the product to IMTEC’s factory. Any such return must be pre-authorized by IMTEC using issuance of an IMTEC Returned Goods Authorization (RGA) number. The RGA number must be displayed on the returned merchandise. It is the buyer’s responsibility to retain the original packing materials or to obtain authorized replacement packing materials from IMTEC should the heater ever need to be returned to the factory. Refer to Section 6, *Maintenance Procedures*, for the Returned Goods Authorization procedures.
4. The period of warranty commences as of the date of shipment from IMTEC.

Warranty Exclusions

1. While other Exclusions may apply, IMTEC specifically does not guarantee, and accepts no responsibility for the following:
 - Failure caused by incorrect plumbing: for example, installing with flow opposite to the direction indicated in this manual and on the Accuheat housing, or with piping elevations that may result in vapor-lock to the outlet flow.
 - Failure caused by incorrect mounting, such as upside down or any orientation that results in trapped air inside the heater.
 - Corrosion of the quartz components by non-compatible chemistries such as hydrofluoric acid and potassium hydroxide.
 - Damage as a result of misuse of the IMTEC-supplied Power Modulator.
 - Damage as a result of operating the Accuheat outside the specified limits.
 - Customer modifications to the housing, electrical circuitry, safety sensors and/or accessories;
 - Improper transportation, handling, or installation damage, including, but not limited to, insufficient air gap around the perimeter of the Accuheat; insufficient support of plumbing lines, creating stress on the plumbing connections; use of plumbing nuts other than those supplied with the unit; placement of the Accuheat in a corrosive environment; immersion of the Accuheat in water or other fluids.
 - Unauthorized customer modification to any portion of the system.

NOTE

Unauthorized customer modification(s) may void all warranties.

Damage Related to Shipment

It is the buyer's responsibility to carefully inspect each quartz Accuheat In-Line Heater upon receiving it and to determine if any breakage has occurred during shipping. Claims for quartz found broken in shipment are not the responsibility of IMTEC and should be submitted to the freight carrier. IMTEC recommends such claims be submitted within 5 days of Receipt of Shipment.

Packaging

It is the buyer's responsibility to retain the original packing materials or to obtain authorized replacement packing materials from IMTEC should the equipment ever need to be returned to the factory.

In Conclusion:

NOTE

IMTEC does not warranty merchantability or fitness for any purpose and there are no warranties expressed or implied other than those expressly stated in this document. IMTEC is not responsible for any consequential, incidental or other damages whatsoever. IMTEC's liability is limited to the repair or replacement of such defective product OR refund of purchase price, at IMTEC's sole option, as stated above. All claims must be made in a timely manner and within the warranty period to be considered valid. Please contact IMTEC at:

IMTEC® Acculine

49036 Milmont Drive

Fremont, CA USA 94538

Telephone: (510) 770-1800

Fax: (510) 770-1400

On the Web at: www.imtecacculine.com

E-mail: imteccacculine.com

TABLE of CONTENTS

Title and Copyright Page

Manual Revision History Page

Preface

Intended Use of this Equipment.....	i
Intended Audience.....	i
Safety Considerations.....	i
Environmental Information.....	ii
General Safety.....	ii
Electrical Safety.....	ii
Chemical Safety.....	ii
Before Powering Up the Heater.....	iii
Cleanroom Requirements.....	iii
Customer Support.....	iii
Customer (EHS) Contact Information.....	iii
Preventive Maintenance.....	iv
Conventions Used in this Manual.....	iv
How to Use this Manual.....	v
IMTEC's Accuheat Limited Warranty.....	vi

1. Introduction

1.1 Overview – Basic Model.....	1-1
1.1.1 Power Modulators.....	1-4
1.1.2 IMTEC HotGrip Nut.....	1-4
1.2 Theory of Operation - Heat-Up Times.....	1-5
1.3 Specifications.....	1-6
1.3.1 Environmental Specifications.....	1-6
1.4 Facilities Requirements.....	1-7

2. Safety Requirements

2.1 Emergency Contact.....	2-1
2.2 Electrical Safeguard Recommendations.....	2-2
2.3 In-Use Safety Precautions.....	2-3
2.3.1 Chemical Safety Requirements.....	2-5
2.3.2 Environmental Specifications.....	2-5
2.3.3 Power Modulator.....	2-6
2.3.4 Thermal Snap Switch Information.....	2-6

3. Product Inspection

3.1 Unpacking Considerations.....	3-1
3.2 Inspecting the Packaging.....	3-1
3.3 Checking the Contents.....	3-2

4. Installation Procedures

4.1	Emergency Off (EMO) Recommendations	4-1
4.2	Controller Recommendations.....	4-1
4.3	Plumbing Recommendations	4-2
4.4	Installation Procedures.....	4-4
4.4.1	Installing the Power Modulator	4-4
4.4.2	Installing the Accuheat In-Line Heater	4-5
4.4.2.1	Horizontal Installation	4-5
4.4.2.2	Vertical Installation	4-7
4.4.3	Connecting the Power Modulator	4-8
4.4.4	Connecting the Heater Power and Sensors.....	4-9
4.4.5	Use of the Accuheat without Imtec's Power Modulator	4-10
4.4.6	Connecting the Heater Plumbing	4-10
4.4.6.1	Installing IMTEC Fit-one Nuts	4-11
4.4.6.2	Installing Imtec Hot Grip Nuts	4-13

Addendum – System Schematics

5. Operating Instructions

5.1	Safety Precautions	5-1
5.2	Controls and Indicators	5-3
5.3	Ramp-Up	5-3
5.4	Shut-Down	5-4

6. Troubleshooting and Maintenance Procedures

6.1	Troubleshooting Procedures	6-1
6.2	Maintenance Procedures	6-3
6.3	Removing the Heater	6-3
6.4	Return Authorization Procedures	6-4
6.4.1	Return Policies	6-4
6.4.2	Obtaining a Return Authorization Number	6-5
6.4.3	Packing the Heater for Return	6-5

Updates

NOTE

The Updates section will be empty if this is the Initial shipment of this manual. Updates will follow at the discretion of IMTEC.

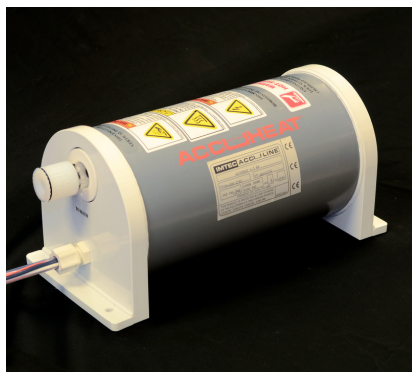

1 INTRODUCTION

This section describes the IMTEC Accuheat Single Tube series of In-Line Heaters. This series includes the Model 4500, 6000, 7500, 12000, and 13000. This section includes the following information:

- Overview of the basic models
- Components Overview
- Specifications
- Facilities Requirements

1.1 Overview – Basic Model

The Accuheat Single Tube model is an efficient in-line heater combining low cost-of-ownership with an extended service life. These models have all-quartz heated surfaces for process purity and can be applied to a number of uses, including filtered RCA cleans, DI water heating, photoresist-strip recirculation, nitride etch recirculation heating or pre-heating, and the heating of any chemical which is quartz-compatible.

These heaters conductively transfer heat for better efficiency and their low-mass heater arrays minimize temperature overshoot. The fluid flow pattern is designed for optimal heat transfer, so the Accuheat can be used for both high-flow and low-flow applications.

The heater module can be interconnected with other Accuheat modules to provide an optimum configuration for temperature rise, fluid flow and three-phase electrical load balancing. A special version of the IMTEC Model 951 Controller is also available for process control.

Product Bulletin

August 10, 2009

Product Line: ACCUHEAT

Models Covered: All Quartz Models

Imtec has had independent laboratory life time testing of its Quartz Inline heater product line, the ACCUHEAT, for chemical compatibility of NH₄OH and water at temperatures up to 60degrees centigrade,.

Two concentrations were tested: 1:5 and 1:16 NH₄OH and water @ 60 & 80 degree centigrade.

Both tests showed some degradation of the quartz material over a period of 8 hours. By extrapolating the resulting data into a projected yearly basis (continuous operation) these products are expected to have a life expectancy of 18-24 months.

Based on these results Imtec has approved the use of these products under the following conditions:

Heater Type: All Quartz Accuheat products

Maximum Media Concentration: 1:5 NH₄OH and Water (Max PH Value 12.5)

Maximum Operating Temperature: 60 C

Projected Life Time Expectancy: 12-18 months- concentration dependent

(Product must be changed after 12 months of usage)

Warranty considerations: Failures resulting from etching of the quartz tube are excluded from warranty coverage.

Product Bulletin

Sept. 29, 2009

Product Line: ACCUHEAT

Models Covered: All Quartz Models

Imtec has used an independent laboratory to perform quartz compatibility testing when using various solutions of Ammonium Hydroxide and water at temperatures up to 60 degrees centigrade. The purpose of these controlled tests was to certify NH₄OH and H₂O chemistries when using any of Imtec's Quartz Accuheat Inline heater products.

Two concentrations were tested: 1:5 and 1:16 NH₄OH and water @ 60 & 80 degree centigrade.

Both tests showed some degradation of the quartz material over a period of 8 hours. By extrapolating the resulting data into a projected yearly basis (continuous operation) these products are expected to have a life expectancy of 18-24 months.

Based on these results Imtec has approved the use of these products under the following conditions:

Heater Type: All Quartz Accuheat products

Maximum Media Concentration: 1:16 NH₄OH and Water

Maximum Operating Temperature: 65 C

Projected Life Time Expectancy: 12-18 months- concentration dependent (Product must be changed after 12 months of usage)

Warranty considerations: Failures resulting from etching of the quartz tube are excluded from warranty coverage.

1.1.1 Power Modulators



The basic purpose of power modulators is to extend the life of the heater application. There are two options for power modulators. The standard power modulator is designed for all processing applications with an operating setpoint temperature of 375°C.

The second power modulator is designed for use with Hot Phosphoric applications with an operating setpoint temperature of 300°C. This lessens the etching effect of the quartz tube.

The purpose of either power modulator is to allow the heater to provide as much heat to the process fluid as it can absorb without overheating when properly installed internal to the electrical enclosure.

Since process temperatures vary with the type of liquid and flow rate the IMTEC heater is capable of providing the maximum amount of heat for any application. When heat is applied beyond where it can be absorbed, the element temperature rises. When the heat reaches the setpoint of the power modulator, the signal to a correctly wired power relay is interrupted until the element temperature drops down below the setpoint where it once again allows the power relay to energize.

The standard Power Modulator is for use with chemistries that do not etch quartz. The setpoint is optimized to get the most efficiency out of the heater. The Hot Phosphoric Power Modulator has a lower setpoint to reduce the etching effect that occurs when the surface temperature exceeds 155°C. This allows the heater to have a much longer life, while having only a minimal effect to heat-up time.

It is important to know that the surface temperatures where the chemistry contacts the quartz will be much higher than in the process vessel or other parts of the recirculation loop. Another factor to apply the Hot Phosphoric power modulator is that Hot Phosphoric is very viscous at lower temperatures. That means that during heat-up, where the power modulator typically sees action, the flow rate is usually much lower than it is with, for instance, water or SC-1. This means that heat cannot be absorbed as fast so a lower modulator setpoint more accurately reflects the maximum amount of heat that the liquid can absorb.

1.1.2 IMTEC FIT-ONE NUTS

The nuts supplied with Imtec inline heaters beginning around September of 2015 come with a special nut designed specifically for the Accuheat quartz flared stems with buttress threads.

When installed correctly, the nuts provide a leak tight connection up to 200°C with no maintenance required. Installation instructions are included in the installation section.

1.1.3 IMTEC HOTGRIP™ NUT (legacy products only)





This is designed to be a “tighten-once” Teflon tubing connector nut that stays tight for the life of the plumbing connection and is suitable for all installations up to 180°C. This nut can replace Flaretek or Pillar high temperature Teflon-tubing connectors.

Designed and tested up to 200°C, the nut’s structure consists of an outer threaded shell (the nut itself); an inner jacket tightened onto the shoulder of the tube’s flared shoulder (the tube retainer) and a fully isolated compression spring that holds the nut and the retainer as far apart as built-in detents permit.

The nut is hand tightened at installation and requires no critical gauging or early heat cycle retightening. When the nut is hand tightened onto the body of the tube connector or fitting, the spring is compressed, locking the nut’s female threads against the connector’s male threads the same way as a lock washer loads a bolt assembly. At the same time, an equal and opposite force loads the leading edge of the tube retainer against the shoulder of the tube’s flare, forcing it forwards onto (or into, depending on the type of connector) the fitting.

1.2 Theory of Operation – Heat-Up Times

The heat-up time curves in the following figure, reflect the amount of time for 35 liters of DI water, 95% sulfuric acid and 85% phosphoric acid, respectively, to raise to operating temperatures using a single tube IMTEC In-Line Heater. The results do not include heat loss from plumbing or other system components. A Model 6000S was used to reflect these times. A line voltage of 208V was used for the chart below. Heat-up rates will vary with the voltage used.

WARNING		
	<p>BURST HAZARD</p> <p>Do not exceed 60 PDI / 414 kPa operating pressure and 356° F / 180° C operating temperature.</p>	

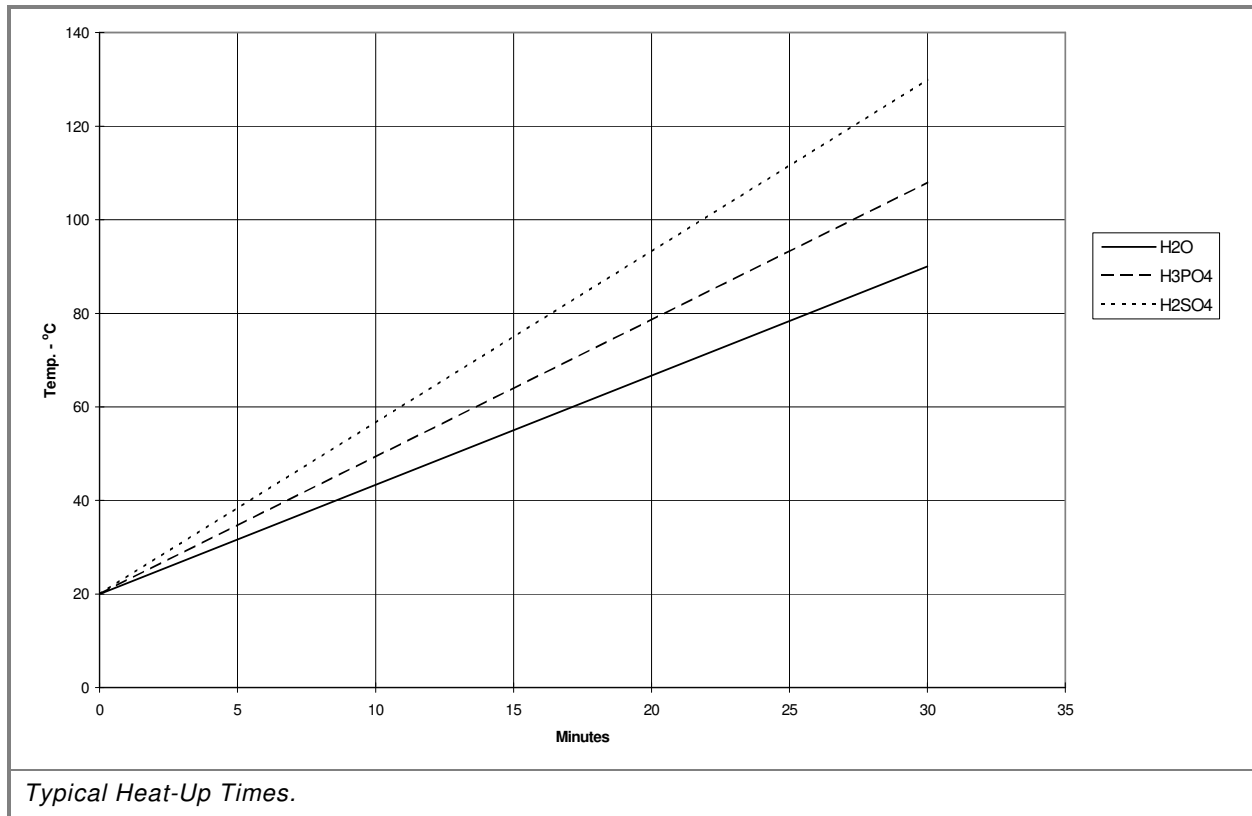

1.3 Specifications

The specifications included in this section are for general use only. A model specific drawing and schematic is included with each heater. Refer to these drawings when working with the heater.

1.3.1 Environmental Specifications

Environmental Temperature	In door use only at 5°C to 40°C
Environmental Humidity	Maximum relative humidity is 80% for temperatures up to 31°C, decreasing linearly to 50% relative humidity at 40°C.
Altitude	Up to 2000 meters (6561.66 feet).
Supply Voltage	MAINS supply voltage fluctuations up to ±10% of the nominal voltage. Transient over voltages typically present on the MAINS supply.
Pollution	Applicable rated pollution degree 1

1.4 Facilities Requirements

The following facilities requirements are model dependent. While reading this section ensure you are referencing your model.

Facilities Requirements				
Model	Model Voltage	Line Voltage	Minimum Recommended Circuit Breaker	Amperage (line current)
AH4500SL	208V (AC 3 ϕ) 50/60 Hz.	200V 208V	20A 15A	12.5 12.0
	240V (AC 1 ϕ) 50/60 Hz.	220V 230V 240V	25A 25A 25A	17.2 18.0 18.8
AH6000SL	208V (AC 3 ϕ) 50/60 Hz.	200V 208V	25A 25A	16.0 16.7
	400V (AC 3 ϕ) 50/60 Hz.	380V 400V	15A 15A	8.2 8.7
AH7500SL*	208V (AC 3 ϕ) 50/60 Hz.	200V 208V	25A 30A	20.0 20.8
	208V (AC 1 ϕ) 50/60 Hz.	200V 208V	45A 45A	34.7 36.0
	400V (AC 3 ϕ) 50/60 Hz.	380V 400V	15A 15A	10.3 10.8
AH9000SL*	208V (AC 3 ϕ) 50/60 Hz.	200V 208V	30A 35A	24.0 24.9
	208V (AC 1 ϕ) 50/60 Hz.	200V 208V	55A 55A	41.6 43.3
	400V (AC 3 ϕ) 50/60 Hz.	380V 400V	20A 20A	12.4 13.0
AH12000SL	400V (AC 3 ϕ) 50/60 Hz.	380V 400V	25A 25A	16.5 17.3
AH13000SL	208V (AC 3 ϕ) 50/60 Hz.	200V 208V	45A 45A	34.7 36.0
*208V models have 6 heater wires and can be wired in parallel for single phase or as a 3 phase delta.				
Modulator Power	Input is 24VAC \pm 10%, 50-60 Hz \pm 5%, 10 VA (watts) maximum power consumption. Relay contact rating: 8 amps at 240VAC or 30 VDC maximum resistive load or 250VA pilot duty, 120/240 VAC maximum inductive load. Use RC suppression for inductive loads.			

This concludes Section 1, *Introduction*.

2 SAFETY REQUIREMENTS

The following recommendations and requirements are included for personal and equipment safety. Please read them completely before installing and operating your Accuheat in-line heater system.

NOTE

These recommendations are advisory in scope. **IMTEC assumes no responsibility for the correct or incorrect installation or use of this equipment in any user's facility.** IMTEC recommends that installation of this equipment be confined to licensed contractors, OEM-provided personnel and/or trained Facility Maintenance personnel.

Ensure you are familiar with your company's Equipment Safety Regulations and Specifications, the local fire marshal codes and applicable electrical code requirements for compliance.

CAUTION



USING IMPROPER CONFIGURATION VALUES CAN CAUSE PRODUCT OR EQUIPMENT DAMAGE

Do not enter set-up or configuration values outside the specified range for any given heater or optional device. To do so may seriously damage your product or equipment.

CAUTION



SAFE OPERATION IS DEPENDENT ON CONTROL SYSTEM

Ensuring that a heater operates safely is dependent on proper controls with backup protection to ensure that the heater is shut down when there are certain fault conditions. It is recommended that users familiarize themselves with Semi S3 guidelines covering the operation of heated chemical systems.

IMTEC's Streamline Single Tube Heater Accuheat Systems are not to be used for any purpose other than for which they were designed. What product is to be produced and how the heater and any optional equipment are to be configured for the allowed processing chemicals and parameters are stated in this Instruction Manual.

2.1 Emergency Contact

In the case of emergency or equipment failure, refer to the **Emergency Contact Form** (under separate cover). For assistance in operating, troubleshooting, or maintaining your heater refer first to this and any other manuals supplied to you by IMTEC. If these manuals do not address your specific needs and questions, please

contact IMTEC Customer Service:

IMTEC Acculine 49036 Milmont Drive Fremont, CA 94538	Phone: (510) 770-1800 Fax: (510) 770-1400
Email: imtec@imtecacculine.com	From 8:00 a.m. to 5:00 p.m., PST, Monday through Friday

When calling, please be at the system, if possible, and be prepared to give a detailed description of the problem.

2.2 Electrical Safeguard Recommendations

Refer to this section and the attached schematics for electrical safety information. If you are using a non-IMTEC controller, refer to the controller manufacturer's documentation for electrical safety information and recommendations.

The Equipment that this heater will be installed in must have a Semi S2-approved EMO circuit, where *“the EMO actuator (button), when activated, must place the equipment into a safe shutdown condition, without generating any additional hazard to personnel or the facility”*. The EMO actuator is required to be installed in close proximity to the equipment and within easy reach of the operator and is required to be marked as a disconnect device according to S2-approved regulations.

Some Single-Tube heaters have multiple heater elements. If you are using one circuit breaker and/or control relays for multiple elements, the rating of the breaker may exceed the current capacity of the heater wiring. Where this occurs, the elements should be individually protected by a fuse or other appropriate protection device. It is the responsibility of the customer to ensure that all wiring in the circuit is properly rated and protected.

WARNING



DANGEROUS VOLTAGE IS PRESENT!

Hazardous voltages exist. To minimize risk of electrical shock, do not open the heater housing. Use caution around exposed circuits. Check area for exposed contacts prior to contacting this equipment.

To ensure operator, equipment, and product safety, use care when operating this equipment. The following warnings must be adhered to.

- The Accuheat comes with safety devices. For your safety and to ensure the Accuheat works as designed, do not disconnect or modify them. Report any malfunctions to IMTEC Customer Service.
- The heater's housing is made of CPVC: avoid any chemicals that could attack this material.
- The use of a GFCI protection device is required for safe operation of the In-Line Heater. The reference ground provided is not intended for use as a safety ground.
- Some heater models use multiple heater elements that may be powered from a common electrical supply. In this case the current rating of the supply circuit

breaker may exceed the current rating of the individual heater wires. Where this is the case, each heater element must have its own circuit protection.

2.3 In-Use Safety Precautions

CAUTION	
	<p style="text-align: center;">HOT SURFACES!</p> <p>Surfaces may be as hot as 200°C. Do not move the heater or touch the hot surfaces of the heater.</p>



The following warning labels are placed on the equipment. Adhere to these safety labels. Do not exceed the label's recommend operating pressures or temperatures.

⚠ WARNING	
	
<p>Burst hazard. Do NOT exceed 60 PSI/414 kPa operating pressure and 356°F/180°C operating temperature.</p>	

	<p style="text-align: center;">⚠ WARNING</p>
<p>Chemical Hazard</p> <p>Hazardous chemicals located within this enclosure. Can cause severe injury or death. Follow approved procedures before servicing.</p>	

	<p style="text-align: center;">⚠ CAUTION</p>
<p>Hot Surfaces.</p> <p>Do Not Touch. Hot surfaces inside. Do not touch. To avoid possible skin burns, disconnect and lockout power and allow surfaces to cool before servicing.</p>	





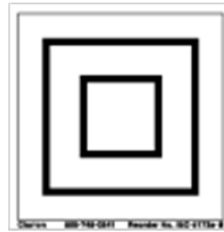

		WARNING
	<p>Hazardous Voltage Enclosed Voltage or current hazard sufficient to cause shock, burn or death. Disconnect and lock out power before servicing.</p>	



The In-Line Heater must be enclosed in a secondary containment area that will hold 110% of the fluid in the entire recirculation system including the process vessel. It is strongly advised that this enclosure be protected with interlocks to prevent operation if the enclosure is not properly sealed.

Read, understand, follow and implement the following general warnings and cautions during the use of this system.

GENERAL WARNINGS	GENERAL CAUTIONS
	<ul style="list-style-type: none"> • Ensure that all protective sensors and automatic shutdowns are attached and functional. • Take extra care when using volatile flammables: fumes are more dangerous than liquids. • The heater's housing is made of CPVC: avoid any chemicals that could attack this material. • DO NOT apply power to the heater without fluid circulating through it. • An over-temperature safety controller is required for installation. Please contact IMTEC Customer Service for specification. • There are no specific procedures for shutting-down the heater, except for maintaining pump flow. Ensure heater power is shut down while the fluid is still recirculating. Then maintain recirculation for at least three minutes to ensure withdrawal of stored heat from the heater.

WARNING	
	<p style="text-align: center;">HAZARDOUS CHEMICALS CAN CAUSE SEVERE INJURY OR DEATH!</p> <p>Process chemicals may remain in the heater while attempting removal procedures if flushing and purging procedures are not followed. Before attempting removal procedures apply your company's personal protective equipment (PPE). PPE equipment must be applied in accordance with the instructions supplied by manufacturer of the PPE equipment.</p> <p>These procedures must be performed while wearing the appropriate personal protective equipment, such as, but not limited to:</p> <div style="display: flex; justify-content: space-around; align-items: center;"> <div style="text-align: center;">  Goggles Apron </div> <div style="text-align: center;">  Gloves </div> <div style="text-align: center;">  Respirator Boots </div> </div>

2.3.1 Chemical Safety Requirements

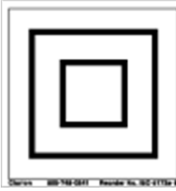
WARNING	
	<p style="text-align: center;">DANGEROUS CHEMICALS MAY BE PRESENT!</p> <p>The In-Line Heater must be enclosed in a secondary containment area that will hold 110% of the fluid in the entire recirculation system including the process vessel. It is strongly advised that this enclosure be protected with interlocks to prevent operation if the enclosure is not properly sealed.</p>
	

2.3.2 Environmental Specifications

Environmental Temperature	In door use only at 5°C to 40°C
Environmental Humidity	Maximum relative humidity is 80% for temperatures up to 31°C, decreasing linearly to 50% relative humidity at 40°C.
Altitude	Up to 2000 meters (6561.66 feet).
Supply Voltage	MAINS supply voltage fluctuations up to ±10% of the nominal voltage. Transient over voltages typically present on the MAINS supply.
Pollution	Applicable rated pollution degree 1

2.3.3 Power Modulator



This power modulator must be installed internal to an electrical enclosure.

2.3.4 Thermal Snap Switch Information

The snap switch is a self resetting thermostatic snap switch that is adhered to the end of the quartz tube on the outlet side and will interrupt the control signal. It is a critical safety device and must be utilized to prevent equipment damage in certain fault conditions.

The snap switch trips at 210°C. Typically if there is liquid flowing through the tube the switch does not trip. If for some reason, the tube is not full of liquid, or partially full, the quartz that is not in contact with liquid may continue to increase in temperature without being sensed by other devices. If the tube reaches 210°C, then the snap switch will open. It is the integrators responsibility to use this switch as part of their control circuit. It typically would be hard wired so that it would remove all power to the heater and require acknowledgement/reset before power could be re-applied.

The snap switch UL rating for 6000 cycles is 6A at 120VAC or 1.5 amps at 240VAC. Non UL rating of 5000 cycles for 30VDC/AC is 7 amps.

3 PRODUCT INSPECTION

This chapter describes guidelines to follow when unpacking and inspecting the IMTEC Accuheat In-Line Heater and standard optional equipment.

NOTE

These guidelines have also been included with the shipping manifest attached to the outside of the shipping container.

3.1 Unpacking Considerations

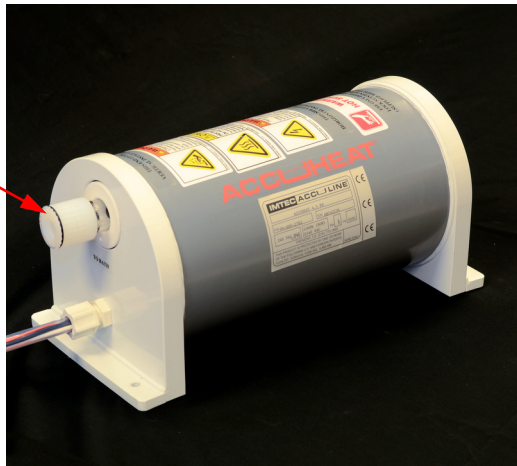
CAUTION	
	<p style="text-align: center;">HANDLE WITH CARE!</p> <p>Quartz, like glass, is fragile and breaks on impact. Handle as for any fragile quartz material. Protect the inlet and outlet tubes from impact at all times.</p> <p>Do not lift the heater by the nuts (either knurled Teflon or Hot Grip) as these nuts are mounted directly on quartz fittings. Mishandling may result in non-warranty covered breakage (see below).</p> <p>Do not lift the heater by the nuts (either knurled Teflon or Hot Grip).</p> <div style="text-align: right;">  </div>

3.2 Inspecting the Packaging

Before opening the shipping container, please look for evidence of transportation damage. It is your responsibility to notify the shipper promptly of any claims of freight damage. Please contact IMTEC also, so that we may be of assistance with an expeditious repair or replacement of the damaged parts.

CAUTION	
	<p style="text-align: center;">POTENTIAL EQUIPMENT DAMAGE!</p> <p>Keep the IMTEC packaging and box in which the system and any options were shipped. If the system should ever need to be returned to IMTEC, it must be returned in an appropriate container to minimize risk of shipping damage. If the original container is not available, purchase a packing kit from IMTEC for a nominal fee.</p>

3.3 Checking the Contents

The Accuheat In-Line heater's shipping carton will contain the heater itself and any accessory components ordered with it. This may include the following items.

Quantity	Equipment
1	Accuheat In-Line heater (model specific)
1	This Instruction Manual
1	Warranty Registration Card (in an envelope)
1	<i>Optional</i> Standard Power Modulator – or – Hot Phosphoric Power Modulator
2	<i>Optional</i> Fit-One Nuts (Typically threaded onto the stems)
1	Torque Wrench Adapter (When Fit-One nuts are included). Imtec P/N 10-004-7007

NOTE
If any of the items you ordered are missing, contact IMTEC immediately.

If the system is shipped consolidated with other components, check your receiving documents and / or additional manuals for a checklist of the pertinent items.

This concludes Section 3, *Product Inspection*.

4 INSTALLATION PROCEDURES

NOTE

The information provided in this section pertains to standard Accuheat models. Certain OEM specific models may have different plumbing and electrical connections in addition to other unique attributes. Where there are discrepancies between this document and your heater refer to the drawings and schematics that came with the heater.

This section includes the following topics:

- Controller Recommendations
- Plumbing Recommendations
- Installation Procedures
- System Schematics

4.1 Emergency Off (EMO) Recommendations

The heater is installed as an internal device within the host equipment. The heater receives its electrical power from the host equipment. The host equipment must provide EMO devices to remove all power including removing power from the heater. This EMO device must be installed close to the equipment and within easy reach of the operator.

The host equipment must connect the over temperature and thermal snap switch to a Semi-compliant safety interlock circuit that will remove the power to the heaters if the maximum settings are exceeded for the thermocouple or if the thermal snap switch opens. Refer to Section 4.4, *Installation Procedures*, for power modulator wiring information.

4.2 Controller Recommendations

CAUTION



SAFE OPERATION IS DEPENDENT ON CONTROL SYSTEM

Ensuring that a heater operates safely is dependent on proper controls with backup protection to ensure that the heater is shut down when there are certain fault conditions. It is recommended that users familiarize themselves with Semi S3 guidelines covering the operation of heated chemical systems.

A controller is necessary for process temperature control and over-temperature protection. If you use a non-IMTEC controller, that controller must drive a separate relay circuit for heater power. The relay circuit should have a primary and secondary relay in series for the line supply to the heaters, with a SSR or other sufficient, high-

cycle rated switching relay used as the primary, and a simple electromagnetic-closed secondary safety relay.

The over-temperature controller should be capable of reaching and maintaining a 410° setpoint.

4.3 Plumbing Recommendations

WARNING	
	<p style="text-align: center;">DANGEROUS CHEMICALS MAY BE PRESENT!</p> <p>The In-Line Heater must be enclosed in a secondary containment area that will hold 110% of the fluid contained in the recirculation loop including the process vessel. It is strongly advised that this enclosure be protected with interlocks to prevent operation if the enclosure is not properly sealed.</p>

The quartz fittings are “flared tube” and accommodate 3/4” OD Teflon tubes flared by means of a Flaretek™ flaring tool, or equivalent. All plumbing connections and fittings must be supported to eliminate any strain on the heater’s quartz plumbing connections. Recommended continuous operating pressure is no more than 40psi (275 kPa, 2.81 kg/cm², 2.76 bar).

The heater is drained through the INLET tube, refer to Section 6, *Troubleshooting and Maintenance Procedures*. To facilitate draining and heater removal, install a manual or automatic drain valve on the INLET tube side.

Never allow the quartz tube to become over pressurized. Read and understand the warning below.

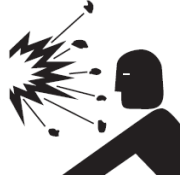
WARNING		
	<p style="text-align: center;">BURST HAZARD</p> <p>Never configure the recirculation loop with valves that could close on either side of the heater and prevent a release of pressure. If a reactive chemistry is allowed to be sealed inside an inline heater with no pressure relief, a burst of the quartz can occur.</p> <p>Do not exceed 60 PSI / 414 kPa operating pressure and 356° F / 180° C operating temperature.</p>	

The tubing between the heater and pump should have a “looped” run rather than a lateral run. Looped runs decrease pump vibrations from stressing the quartz stem (Figure 4-1).

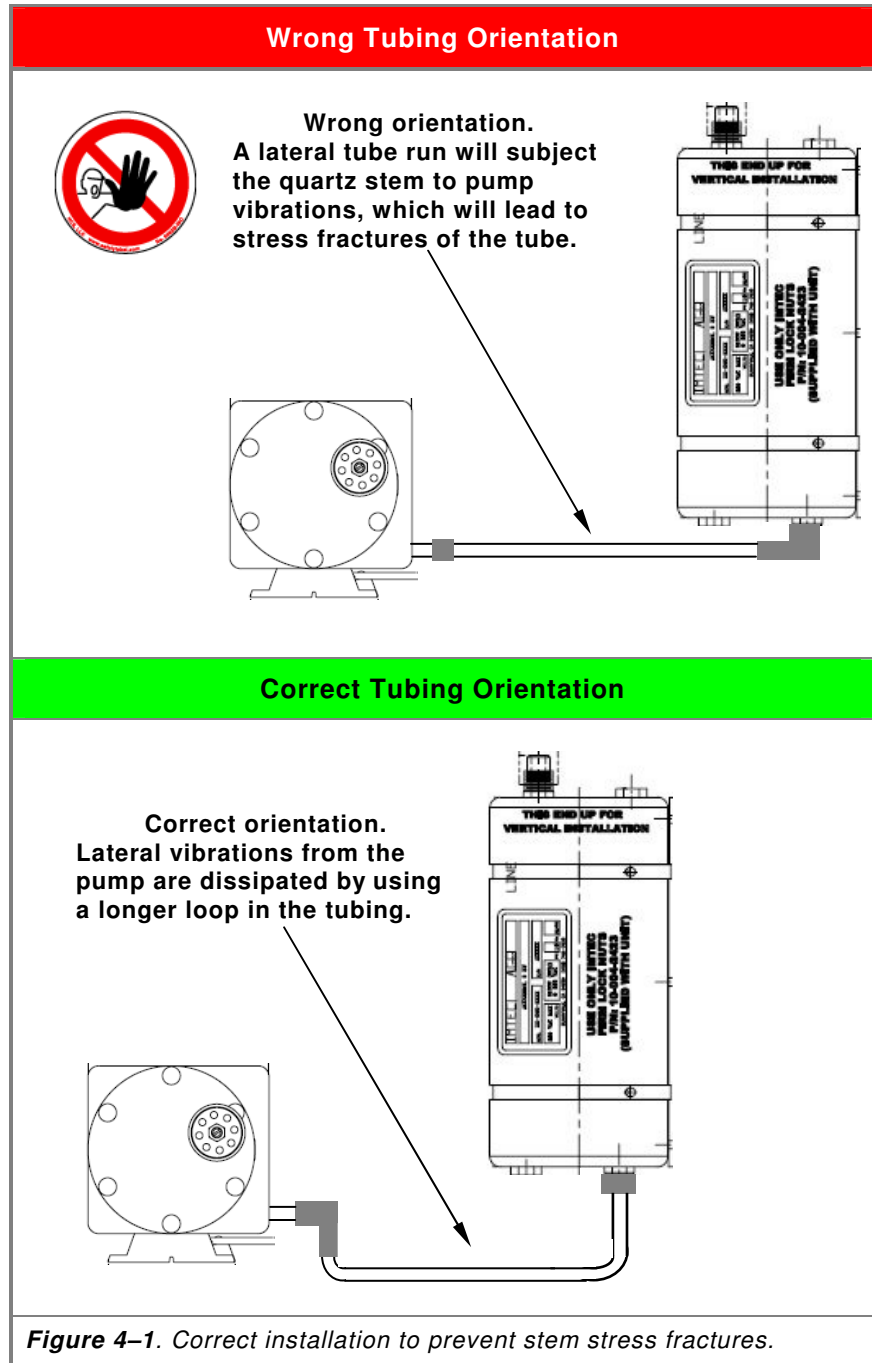

4.4 Installation Procedures

Installation of any of the Single Tube Accuheat models are divided into these parts:

- Installing the Power Modulator
- Installing the Heater
- Connecting the Power Modulator
- Connecting the Heater Power And Sensors
- Connecting the Heater Plumbing
- Making the plumbing connections

4.4.1 Installing the Power Modulator

CAUTION	
	<p style="text-align: center;">POTENTIAL PRODUCT OR EQUIPMENT DAMAGE!</p> <p>The power modulator is an optional component but its function is critical to assuring reliable operation. Customers choosing not to use Imtec's power modulator must perform the same function as part of their control system. Failure to do so will void the warranty.</p>

For customers using an Imtec supplied power modulator, please following the following steps. If another method is being used, skip to Paragraph 4.4.5

Install the Power Modulator in a chemical-free environment such as an enclosed electronics compartment of the wetstation or a well-ventilated head case. This modulator can also be DIN Rail mounted using DIN 50022, 35 mm X 7.5 (1.38-inch X 0.30-inch).

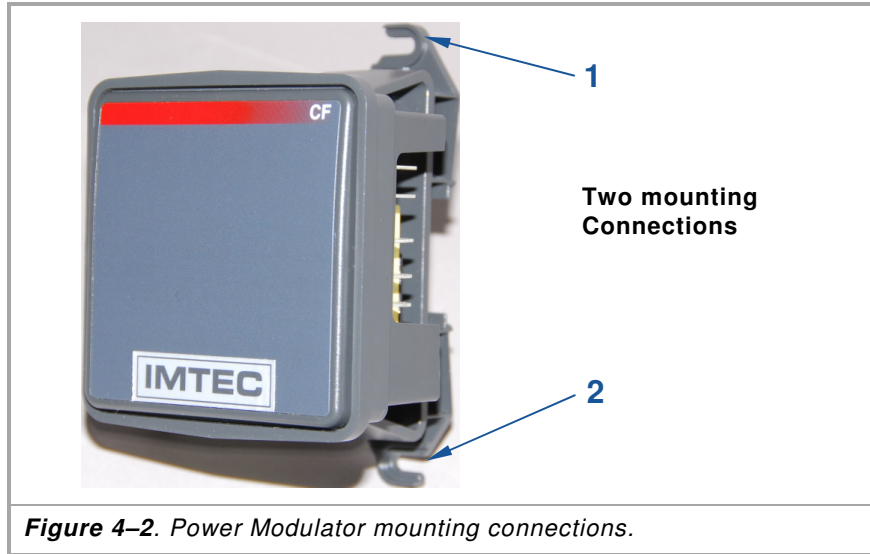

1. Drill and tap two 2.7 mm (0.106) diameter holes in the desired panel location. Mount the Power Modulator using two (2) #6 (M3.5) screws. IMTEC recommends mounting the modulator as close to the heater control relay as possible (Figure 4-2).



4.4.2 Installing the Accuheat In-Line Heater

There is no specified minimum or maximum distance from the bath, but the closer the heater’s OUTLET is positioned to the bath INLET, the more stable the recirculating system will be. Minimize the overall length of the plumbing loop and insulate the plumbing lines where possible to minimize heat loss.

Select a suitable location with a sturdy platform for mounting the heater (IMTEC recommends the heater be installed within the wetbench rear access chase). Heaters may be mounted vertically or horizontally. Make sure to check your specific model and follow the mounting instructions. Ensure all operating environment requirements are adhered to as stated in Section 1.4, *Specifications*, and Section 1.5, *Facilities Requirements*.

WARNING		
	<p>DANGEROUS CHEMICALS MAY BE PRESENT!</p> <p>The In-Line Heater must be enclosed in a secondary containment area that will hold 110% of the fluid contained in the entire recirculation loop including the process vessel. It is strongly advised that this enclosure be protected with interlocks to prevent operation if the enclosure is not properly sealed.</p>	

CAUTION**POTENTIAL PRODUCT OR EQUIPMENT DAMAGE!**

A typical heater may be installed horizontally or vertically. If installing the heater in a vertical orientation, the “To Bath Exit” end must be oriented upwards. Please follow the instruction on the heater when installing vertically or warranty may be voided.

4.4.2.1 Horizontal Installation

1. Using eight (8) ¼-inch diameter (6mm) screws (not provided), pre-drill (tapping as necessary) the mounting platform. Make sure that the horizontal installation label is facing up and the outlet fitting is in the 12-o’clock position (Figure 4-3). Mount the heater to the platform in a level position ($\pm 1^\circ$ at both “x” and “y” axes).

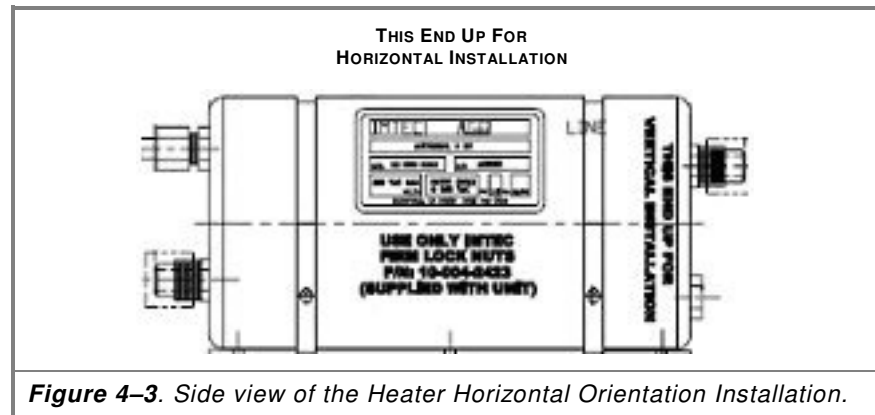

Figure 4-3. Side view of the Heater Horizontal Orientation Installation.

CAUTION**POTENTIAL PRODUCT OR EQUIPMENT DAMAGE!**

Do not install the heater without a minimum of a 5-inch air gap clearance on all sides — heat buildup and / or heater failure will result.

2. Ensure that the heater has at least a 5-inch (12mm) air gap clearance on all sides.
3. Connect power and plumbing as described in Sections 4.4.3 and 4.4.5.

4.4.2.2 Vertical Installation

1. Using eight (8) ¼-inch diameter (6mm) screws (not provided), pre-drill (tapping as necessary) the mounting platform. Make sure that the Vertical installation label is facing up (Figure 4-4). Mount the Accuheat 6000 to the platform in a level position ($\pm 1^\circ$ at both “x” and “y” axes).

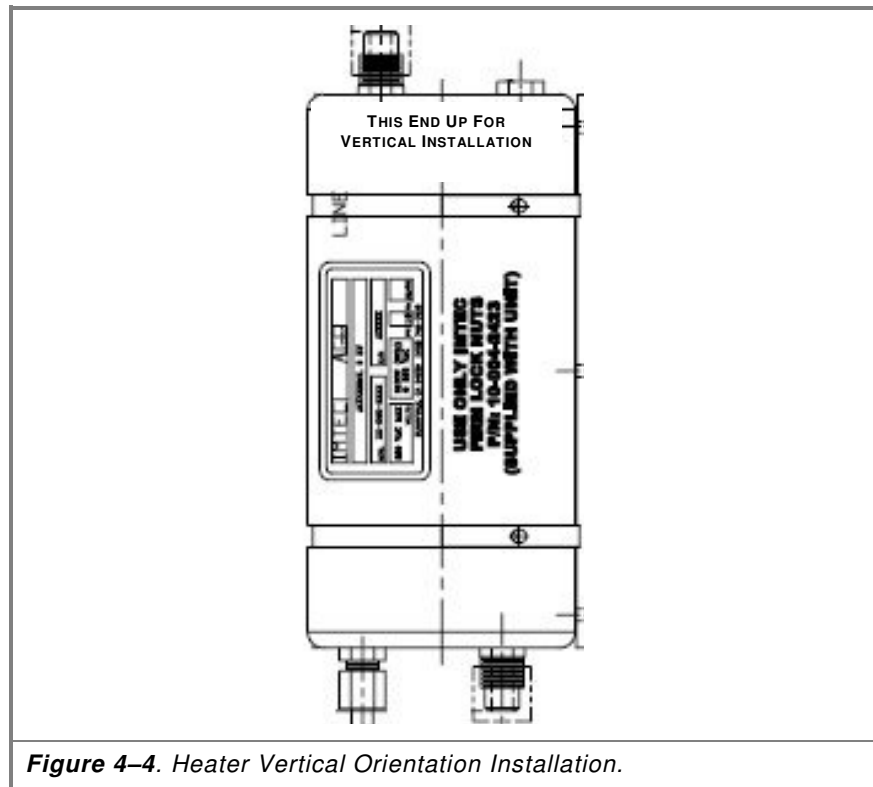

CAUTION



POTENTIAL PRODUCT OR EQUIPMENT DAMAGE!

Do not install the heater without a minimum of a 5-inch air gap clearance on all sides — heat buildup and / or heater failure will result.

2. Ensure that the heater has at least a 5-inch (12mm) air gap clearance on all sides.
3. Connect power and plumbing as described in Sections 4.4.3 and 4.4.5

4.4.3 Connecting the Power Modulator

The Power Modulator is provided with 6.4 mm (0.25-inch) quick connect, push-on terminals. Refer to Table 4-1 below for power and connection descriptions.

Table 4-1. Power Modulator Output Specifications and Connections Descriptions.

<p>Modulator Power Input and Output Power Specifications</p>	<p>Input is 24VAC \pm 10%, 50-60 Hz \pm 5%, 10 VA (watts) maximum power consumption.</p> <p>Output is 8 amps at 240VAC or 30 VDC maximum resistive load or 250VA pilot duty, 120/240 VAC maximum inductive load.</p> <p>IMTEC part number 10-000-2366 for DIN Rail Mount – Spade Terminals, Type J-210 to 1038 °C, Control Type-Heat (@375 °C) 230-240VAC 50/60 Hz.</p> <p>IMTEC part number 10-000-2367 for DIN Rail Mount – Spade Terminals, Type J-210 to 1038 °C, Control Type-Heat (@300 °C) 230-240VAC 50/60 Hz.</p>
<p>(3)</p>	<p>Position 3 – Thermocouple Negative (TC-)</p>
<p>(4)</p>	<p>Position 4 – Thermocouple Positive (TC+)</p>
<p>(6)</p>	<p>Position 6 – Relay Labeled NORMALLY OPEN. Actually NORMALLY CLOSED when is power on and less than 375 deg C. Wire in series with heater control signal so that when Power Modulator relay opens above 375 deg C, power to heater is interrupted until temp reduces.</p>
<p>(7)</p>	<p>Position 7 –Relay common pole for the (6) connection discussed above</p>
<p>(9)</p>	<p>Position 9 – Primary Power (VAC Voltage In)</p>
<p>(10)</p>	<p>Position 10 – Primary Power (VAC Voltage In)</p>

4.4.4 Connecting the Heater Power and Sensors

CAUTION



POTENTIAL PRODUCT OR EQUIPMENT DAMAGE!

An over temperature safety controller is required for installation. If your heater controller has a separate overtemperature input compatible with a J-type thermocouple, a second safety controller is not necessary. A J-Type thermocouple is provided and the required set point is 410°C. When using Hot Phosphoric applications the required set point is 350°C

Electrical schematics have been provided with this manual to serve as the most common standards for electrical and control connection recommendations. Select the appropriate standard for your configuration and wire the system as indicated in the schematics. If your configuration does not match one of these standards, please contact IMTEC Customer Service for assistance.

Thermal Snap Switch Information:

The snap switch is a self resetting thermostatic snap switch that is adhered to the end of the quartz tube on the outlet side and will interrupt the control signal. It is a critical safety device and must be utilized to prevent equipment damage in certain fault conditions.

The snap switch trips at 210°C. Typically if there is liquid flowing through the tube the switch does not trip. If for some reason, the tube is not full of liquid, or partially full, the quartz that is not in contact with liquid may continue to increase in temperature without being sensed by other devices. If the tube reaches 210°C, then the snap switch will open. It is the integrators responsibility to use this switch as part of their control circuit. It typically would be hard wired so that it would remove all power to the heater and require acknowledgement/reset before power could be re-applied.

The snap switch UL rating for 6000 cycles is 6A at 120VAC or 1.5 amps at 240VAC. Non UL rating of 5000 cycles for 30VDC/AC is 7 amps.

4.4.5 Use of the Accuheat SL without Imtec's Power Modulator

As noted earlier the function of the power modulator is critical to assuring a safe and reliable installation. The function of the power modulator is to limit the heater element temperature to prevent overheating. This is done by monitoring one of the J-type thermocouples on the heater element and interrupting the signal to the heater control relay when the temperature exceeds the setpoint. The standard setpoint is 375°C, which is used for applications where quartz compatible chemistry is used. For chemistries such as hot phosphoric acid, mild bases, or other chemicals that have a slow etching effect on quartz, a 300°C setpoint is recommended.

To perform the power modulator function, the customer may choose to use a discrete device or incorporate the function into the temperature control logic of a PLC or other controller. In all cases, it should function as shown in Figure 4-5

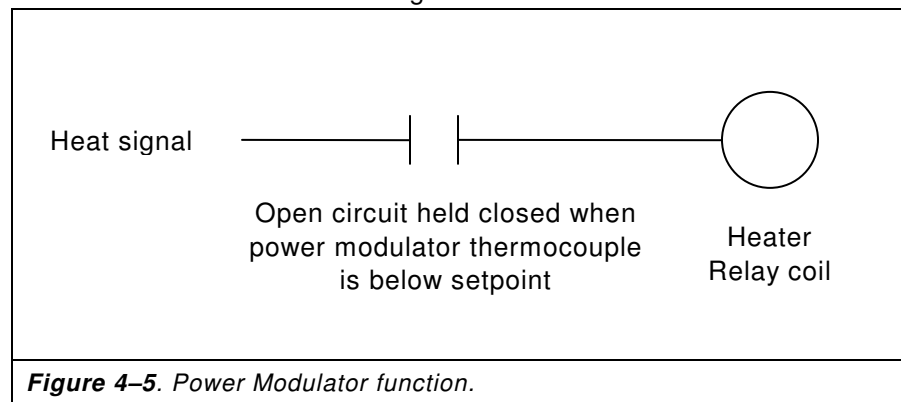

The contacts in the circuit should be self-resetting so that once the heater temp drops below the setpoint, the heater is operable.

4.4.6 Connecting the Heater Plumbing

CAUTION	
	<p style="text-align: center;">POTENTIAL PRODUCT OR EQUIPMENT DAMAGE!</p> <p>When planning the plumbing route, it is important that the flow from the pump through the succeeding circuit components be in a continuing upward angle so that no downward element can serve as a vapor trap. This is most critical in the plumbing circuit from the heater OUTLET port to the bath. Failure to correctly plumb the heater will void the warranty!</p>

The Imtec Fit-One nuts should be tightened with a torque wrench for maximum security. Please read and follow the guidelines below.

4.4.6.1 Installing the Fit-One plumbing nuts.

The Fit-One nuts need to be torqued to provide maximum security against leaks. Any 1/4" drive torque wrench with a range of at least 0-50 in.lbs. may be used. These are readily available online and in hardware stores.

1. Determining the proper torque value.

The torque wrench must be adjusted based on its pivot length. The correct torque spec for the IMTEC FIT-ONE nut is 28 in•lb. But, because torque wrenches come in different lengths, the proper setting for the torque wrench must be calculated based on the formula below to work properly with the IMTEC torque wrench adapter and achieve the desired 28 in•lb.

Measure the distance from the center of the 1/4" drive attachment to the middle of the handle grip. The handle grip is typically knurled. For most accurate torque calculations, measure to the middle point of the grip (referred to as the "1/2 grip length"). This is dimension "A".

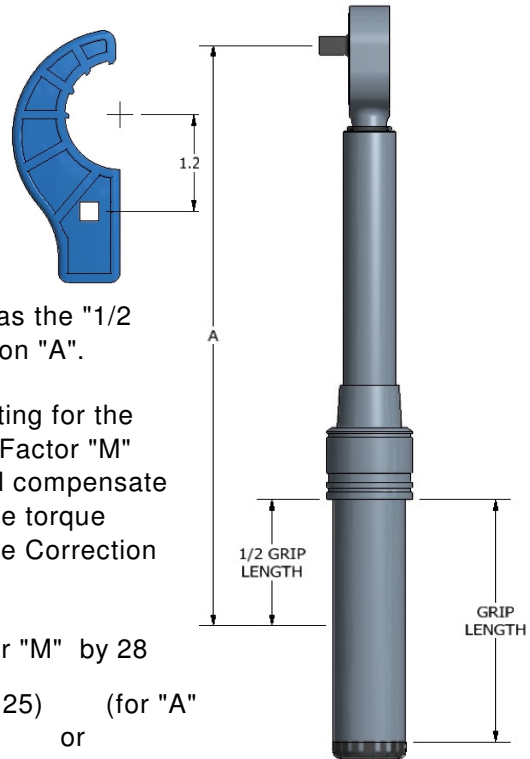

To determine the correct setting for the torque wrench, a Correction Factor "M" must be calculated which will compensate for the additional length of the torque wrench adapter. Calculate the Correction Factor "M" as follows:

Multiply the Correction Factor "M" by 28

$$M = A / (A + 1.25) \quad (\text{for "A"}$$

or

$$M = A / (A + 31.75) \quad (\text{for "A",})$$

lb•in to determine the correct setting for your specific torque wrench: Torque Wrench Setting = (28 in•lb) * M

Using IMTEC's Torque Wrench Adapter to Install Imtec FIT-ONE Nuts

With the proper torque setting on your torque wrench, the torque wrench adapter (P/N:10-004-7007) may now be used. Slide the square cutout in the adapter onto the torque wrench. Make sure the torque wrench adapter remains parallel to the torque wrench handle.

2. Imtec FIT-ONE Nut Installation Steps

Select either the inlet or outlet tube to the heater. Slide the nut onto the tube with the threads facing the end and then the impact ring as shown.

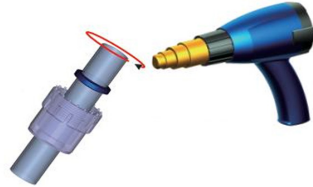

Using a Hot-air gun or heat flaring tool, heat up the tube end while rotating it to ensure even heating. Heat until the tube softens and becomes pliable.

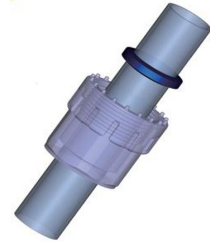

Insert the flaring tool into the tube and hold it there till the tubing cools.

Remove the flaring tool and install the tube onto the quartz flared stem of the heater. Tighten the nut till snug and then complete tightening using the torque wrench.

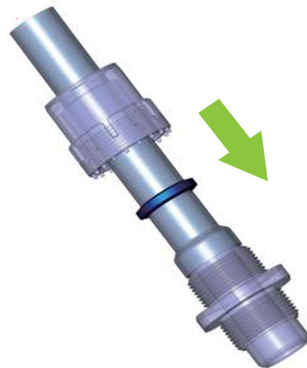
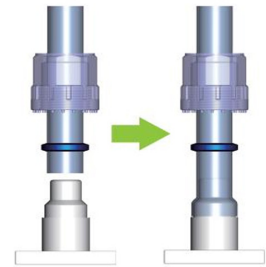

3. Repeat for the second connection ensuring that the flow direction corresponds to the "INLET" and "OUTLET" fittings as necessary. Failure to correctly plumb the heater will void the warranty.

NOTE

If it is necessary to install an elbow onto the heater, a special elbow adapter is available from Imtec.

4. Install brackets or other such support as necessary to eliminate any strain on the heater's quartz fittings.

4.4.6.2 Installing IMTEC Hot-Grip Nuts

The nut is installed the same way as Flaretek nuts except for the tightening procedure.

There are three (3) rings on the back of the nut. The outer two rings are stationary and are always flush with each other. The small center ring is spring loaded.

Before installation, small center ring will be recessed in the nut body. As it is hand-tightened, it will move out towards the other two rings. Stop hand-tightening when the center ring is flush with the other two outer rings (Figure 4-6). This should remain a permanent installation with no maintenance or re-tightening needed.

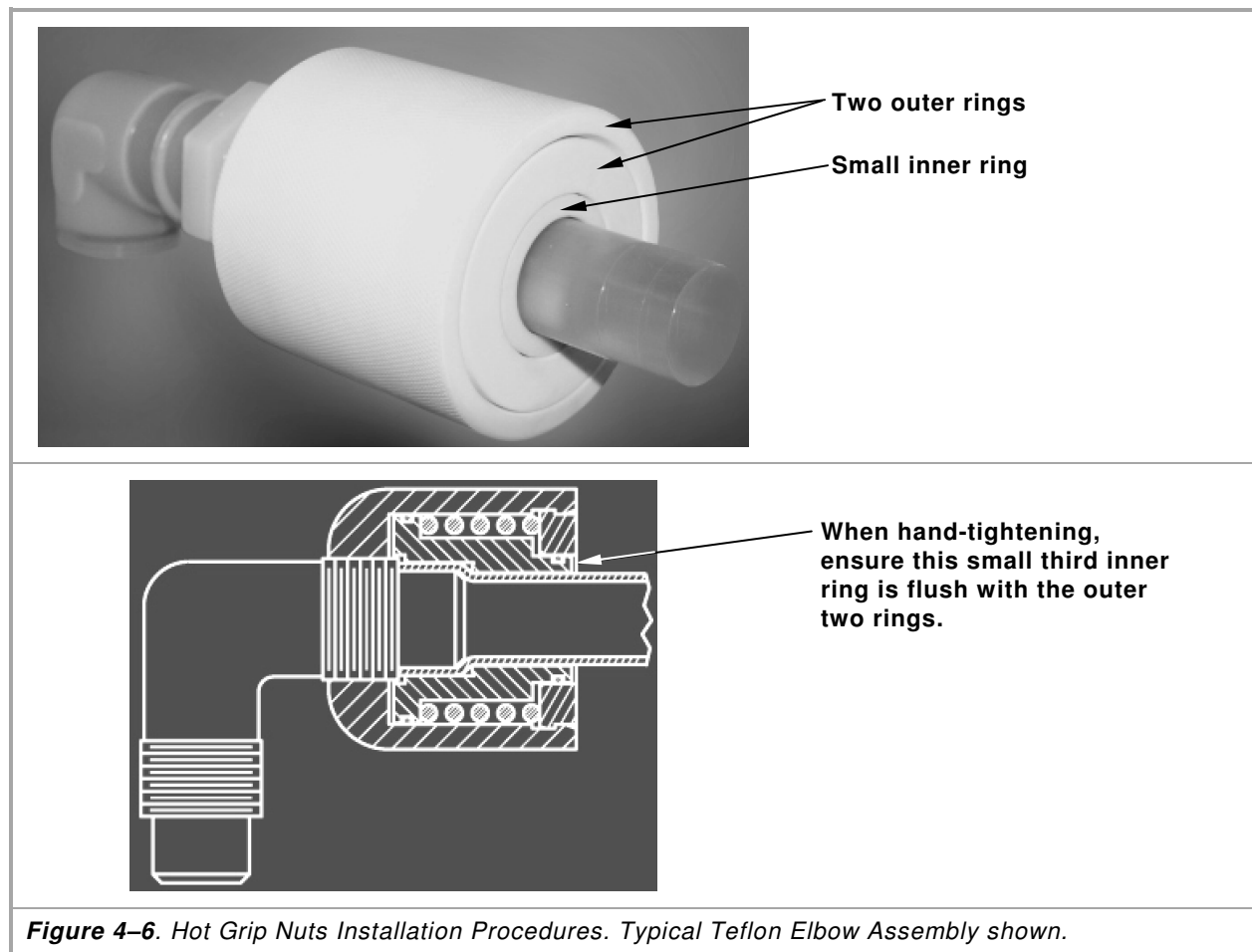

Figure 4-6. Hot Grip Nuts Installation Procedures. Typical Teflon Elbow Assembly shown.

This concludes Section 4, *Installation Procedures*.

5 OPERATING INSTRUCTIONS

This section describes the operation of a typical Accuheat Single Tube In-Line Heater. The information includes:

- Safety Precautions
- Controls and Indicators
- Ramp-Up
- Shut-down

5.1 Safety Precautions

As stated in Section 2, *Safety*, and re-stated here for your safety:

CAUTION	
	<p>HOT SURFACES!</p> <p>Surfaces may be as hot as 200°C. Do not move the heater or touch the hot surfaces of the heater.</p>

The following warning labels are placed on the equipment. Adhere to these safety labels. Do not exceed the label's recommend operating pressures or temperatures.

WARNING	
	
<p>Burst hazard. Do NOT exceed 60 PSI/414 kPa operating pressure and 356°F/180°C operating temperature.</p>	

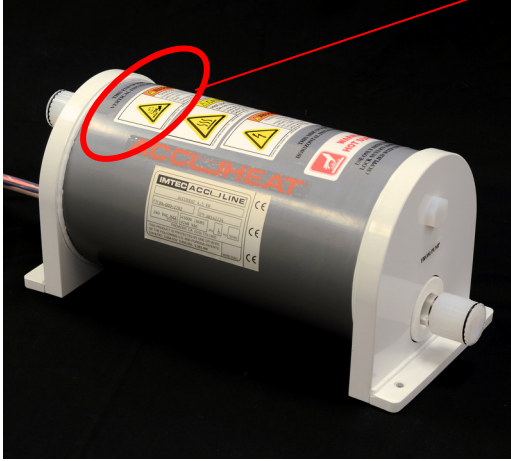

		WARNING
	<p>Chemical Hazard Hazardous chemicals located within this enclosure. Can cause severe injury or death. Follow approved procedures before servicing.</p>	

		CAUTION
	<p>Hot Surfaces. Do Not Touch. Hot surfaces inside. Do not touch. To avoid possible skin burns, disconnect and lockout power and allow surfaces to cool before servicing.</p>	

		WARNING
	<p>Hazardous Voltage Enclosed Voltage or current hazard sufficient to cause shock, burn or death. Disconnect and lock out power before servicing.</p>	

WARNING		
	<p>DANGEROUS CHEMICALS MAY BE PRESENT! The In-Line Heater must be enclosed in a secondary containment area that will hold 110% of the fluid the heater in the entire recirculation loop including the process vessel. It is strongly advised that this enclosure be protected with interlocks to prevent operation if the enclosure is not properly sealed.</p>	

Read, understand, follow and implement the following general warnings and cautions during the use of this heater.

GENERAL WARNINGS	GENERAL CAUTIONS
	<ul style="list-style-type: none"> • Ensure that all protective sensors and automatic shutdowns are attached and functional. • Take extra care when using volatile flammables: fumes are more dangerous than liquids. • The heater’s housing is made of CPVC: avoid any chemicals that could attack this material. • DO NOT apply power to the heater without fluid circulating through it. • An over-temperature safety controller is required for installation. Please contact IMTEC Customer Service for specification. • There are no specific procedures for shutting-down the heater, except for maintaining pump flow. Ensure that the heater power is shut down while the fluid is still recirculating. Then maintain recirculation for at least three minutes to ensure withdrawal of stored heat from the heater.

5.2 Controls and Indicators

The standard heater has no indicators or user controls. External controllers must be used with this equipment. Refer to the operating instructions of the external controller used with this application.

5.3 Ramp-Up

Ensure that the fluid pump is turned on before powering up the heater. Ideally, the INLET pressure at the heater should not exceed 40 PSI (275 kPa, 2.81 kg/cm², 2.76 bar). The absolute maximum is 60 PSI as stated on the product’s warning label.

⚠ WARNING



Burst hazard. Do NOT exceed 60 PSI/414 kPa operating pressure and 356°F/180°C operating temperature.

CAUTION	
	<p>POTENTIAL PRODUCT OR EQUIPMENT DAMAGE!</p> <p>Do not power-up the heater unless there is fluid circulating through it.</p>

5.4 Shut-Down

There are no specific procedures for shutting-down the heater, except for maintaining pump flow.

Ensure that the heater power is shut down while the fluid is still recirculating, then maintain recirculation for at least three minutes to ensure withdrawal of stored heat from the heater.

This concludes Section 5, *Operating Instructions*.

6 TROUBLESHOOTING and MAINTENANCE PROCEDURES

6.1 Troubleshooting Procedures

Most problems related to heating involve the “non”-IMTEC supplied control system and interlock systems that are used in conjunction with the heater. Most troubleshooting is performed to determine if the heater has failed or whether the symptoms are related to an external system. The heater has no user serviceable parts inside and should never be opened for any reason.

The following table lists common symptoms, probable causes, and corrective actions.

Symptom	Possible Cause	Check	Corrective Action
Heater does not heat	No Power to the heater	When the control system is calling for heat, check for voltage to all heater elements. This should be checked at the end of the heaters power cable to eliminate all other connections and interlocks.	If no voltage is present, refer to the control system schematic provided by the tool maker for troubleshooting information. If there is voltage at the heater wires, measure heater resistance as noted below.
	Heater Element Failure	Disconnect the heater power wires from the control system and measure the resistance of the heater element(s) to see that they are within +/-10% of the specification. Refer to model specific information for specs.	If the resistance is in spec, the heater elements are good. If they are out of spec, the unit should be returned to Imtec for repair. In most cases, the heaters can be rebuilt.
Heater Snap Switch is open	Air trapped in heater	Ensure that heater is mounted so that air cannot be trapped inside. Refer to Section 4, <i>Installation Procedures</i> .	Correct the mounting per the installation section and measure resistance of the heater elements to ensure they were not damaged. Once the heater has cooled the snap switch should reset.
	Defective Snap Switch	When the heater has been deenergized for at least 15 minutes, measure for continuity across the snap switch leads.	If the tube is not being heated and the snap switch reads open, it is defective. The heater should be returned to Imtec for repair.
LD-1 Leak Detect Alarm	Internal Leak	Refer to your model schematic and measure the resistance of the 100kΩ terminating resistor on the leak detect wiring.	If the resistance is greater than 60kΩ and less than 120kΩ it should not trigger the leak detect module. Refer to the LD-1 Manual for troubleshooting.

Symptom	Possible Cause	Check	Corrective Action
Visible liquid coming from heater housing	Internal Leak	Certain chemistries will etch quartz and over time create pinhole leaks that may not cause an immediate fault.	Immediately shut down the heater and return to Imtec for evaluation.
Overtemp circuit has tripped	Improper Overtemp setpoint	Check to see that the Overtemp setpoint is a minimum of 25°C above the setpoint of the power modulator setpoint.	Raise the Overtemp setpoint accordingly.
	Defective Overtemp controller	This item is not supplied by Imtec. Refer to the documentation supplied with your tool for troubleshooting.	Repair or replace as necessary.
	One J-type thermocouple is defective	Connect both thermocouple leads to a thermocouple meter. With a cool heater both thermocouple should read within a few degrees of each other.	If either thermocouple is defective, the heater must be returned to Imtec.
	Power modulator is faulty	If both thermocouples check ok, the power modulator may be defective. Connect a J-type thermocouple simulator up to the power modulator and set for 10°C above it's setpoint. This should cause the interlock relay contacts to open.	If the contacts do not open the power modulator is defective and should be replaced. Contact Imtec for a replacement.

This ends the Troubleshooting Procedures. If the heater needs to be returned to IMTEC for servicing go to Section 6.3, *Removing the Heater*.

6.2 Maintenance Procedures

Monthly: Check to ensure that the plumbing connections at the INLET and OUTLET are not leaking. If they are re-install the plumbing connection per the instructions in the installation section.

NOTE

There are no other maintenance procedures nor are there any periodic maintenance (PM) procedures necessary. The follow information readies the heater for returning it to the IMTEC factory for repair.

6.3 Removing the Heater

WARNING



DANGEROUS VOLTAGE IS PRESENT!

Hazardous voltages exist. Use caution around exposed circuits. Check area for exposed contacts prior to contacting this equipment. To ensure operator, equipment, and product safety, use care when operating this equipment. The following warnings must be adhered to.

- The Accuheat comes with safety devices. For your safety and to ensure the Accuheat works as designed, do not disconnect or modify them. Report any malfunctions to IMTEC Customer Service.
- The heater's housing is made of CPVC: avoid any chemicals that could attack this material.

WARNING



HAZARDOUS CHEMICALS CAN CAUSE SEVERE INJURY OR DEATH!

Process chemicals may remain in the heater while attempting removal procedures if flushing and purging procedures are not followed. Before attempting removal procedures apply your company's personal protective equipment. These procedures must be performed while wearing the appropriate personal protective equipment, such as, but not limited to:



Goggles



Gloves



Respirator

Apron

Boots

CAUTION



POTENTIAL PRODUCT OR EQUIPMENT DAMAGE!

A heater that has suffered an electrical failure may be returned to IMTEC for economical repair. However, breakage of the quartz will significantly increase repair costs and may result in the heater not being able to be repaired. Be particularly careful of the quartz flared INLETS and OUTLETS; carefully re-mount the knurled Teflon nuts to protect these quartz items.

1. Ensure all electrical power has been turned off to the heater
2. Purge, flush, and drain the entire recirculation loop and refill with DI H₂O. Recirculate for 10 minutes and then drain the system. Repeat until chemical is satisfactorily diluted.
3. The heater will drain from the INLET tube. Open the manual or automatic drain valve installed on the INLET side, making sure that adequate drainage is available to receive the fluid.
4. Lock out and Tag out the electrical supply and then disconnect the heater wiring from any control systems.
5. Disconnect the OUTLET line and allow the fluid to siphon until empty (typically 20-30 ml of water will remain after siphoning).
6. Carefully re-mount the knurled Teflon nuts to protect the quartz INLETS and OUTLETS.
7. Flush the housing externally with DI water.
8. Remove any hold-down hardware.
9. Remove the heater.

NOTE

When returning the heater for repair, drain, dry, and repackage it as described in Section 6.4, *Return Authorization Procedures*.

6.4 Return Authorization Procedures

The following policies and procedures are for returning a heater for repair to the IMTEC factory

- Return Policies
- Obtaining a Return Authorization
- Packing the heater for return

6.4.1 Return Policies

1. All heaters should be returned in IMTEC shipping containers. If the original container is no longer available, a shipping container can be purchased for a nominal fee from IMTEC Customer Service.
2. All returned heaters must be authorized by an IMTEC representative. If a heater is shipped to IMTEC without a Returned Goods Authorization (RGA) number, the heater will be refused by the IMTEC Receiving Department and returned to the sender.
3. All freight charges are the responsibility of the shipper. Insure for full or repaired value.

6.4.2 Obtaining a Return Authorization Number

1. Please have the following information ready:
 - Serial number of the heater
 - Reason for the repair
 - Type of chemistry used with the heater
 - Process temperature used
 - Repair Purchase Order Number (used for tracking; there can be no charge amount until the heater has been evaluated by IMTEC).
2. Call IMTEC Customer Service at 510-770-1800 and request an RGA number.
3. If needed, order a shipping container kit and / or approved plastic bags. If the heater is contaminated with process chemistry (**not** DI water), ask for a contamination shipping kit.

NOTE

Always follow your company's procedures for handling and shipping of chemically contaminated material. Follow any applicable local, state, and Federal laws in regards to shipping chemically contaminated materials.

4. For contaminated heaters, cut the power cable leaving two (2) inches from the housing nut.

6.4.3 Packing Heater for Return or Decommissioning

1. Have the heater shipping container ready.
2. Ensure that heater housing has been neutralized of all chemicals. Test with pH paper.
3. Provide a description of the chemistry and process temperature used with the heater.
4. Disconnect the electrical connections and plumbing and tape the power cable to the outside.
5. Flush the heater internally and externally with DI water. Drain the heater until no free moisture is present.
6. Repeat step 5 until chemistries are neutralized. Test with pH paper.
7. Insert the heater into an approved plastic bag. Three (3) are supplied with the shipping kit. Additional bags may be obtained from IMTEC Customer Service.
8. If it was necessary to remove any of the PFA manifolds from the heater, make sure they are also bagged and packed in such a way as to not damage the heater.

9. Carefully and completely squeeze out all of the trapped air. Seal the bag with a tie-wrap.
10. Repeat steps 8 and 9 twice more, using the remaining two bags.
11. Carefully place the bagged heater into the lower molded foam section in the shipping container.
12. Place upper molded foam section in place over the heater.
13. Pull up the bag liner, twist its top once and squeeze out all trapped air. It is important that all trapped air be removed. Twist the liner excess to seal out the air and use a tie-wrap to secure the liner top. This ends the decommissioning steps.
14. Insert any photos, diagrams and documentation of chemicals and process temperature into a sealable plastic bag and place on top of box liner.
15. Seal the bath's shipping container with packing tape. Do not staple the container closed.
16. Remove the backing and secure a shock watch and companion label to the side of the container.
17. Write or apply the following labels on all sides of container (except bottom). These labels are: "**GLASS**" and "**FRAGILE**".
18. Mark the RGA number legibly on the sides of the container.
19. Ship the container to IMTEC.

NOTE

IMTEC provides pick-up service for products requiring repair in the Santa Clara Valley. Call IMTEC Customer Service for information.

If you have any questions about IMTEC's return authorization policies or procedures, please contact IMTEC at:

IMTEC Acculine 49036 Milmont Drive Fremont, CA 94538	Phone: (510) 770-1800 Fax: (510) 770-1400
Email: imtecc@imteccaculine.com	From 8:00 a.m. to 5:00 p.m., PST, Monday through Friday