



AP40EXT3 Owner's Manual



Table of Contents

1. Product Information	1
1.1 Specifications & Performance	1
1.2 Temperature Limits.....	2
1.3 Dimensions	2
1.4 Bill of Materials.....	3
2. Installation	4
2.1 Precautions	4
2.2 Warnings	5
2.3 Advantages	5
2.4 Environment & System.....	5
2.5 Installation Instructions.....	6
2.6 Shuttle Service Instructions.....	7
3. Pump Service	8
3.1 Ordering Instructions.....	8
3.2 Rebuild Information	9
3.3 Rebuild Kits & Parts	9
3.4 Return Pump for Service.....	10
4. Warranty	12





Dear valued customer,

Thank you for purchasing a White Knight AP40EXT3 pump.

Our dedicated team designs products to meet your exacting specifications with the highest commitment to quality.

White Knight provides the highest quality fluid handling products through controlled, consistent in-house engineering and manufacturing. Our safe, reliable products offer superior performance, optimized efficiency, and simplified maintenance. We continue to lead the industry with new technologies and products.

Our patented designs offer a variety of size and material options to meet stringent requirements of high-pressure chemical delivery systems; high-temperature re-circulation processes; chemical reclaim and bulk transport applications; as well as slurry systems.

White Knight has received many prestigious awards for innovation and manufacturing programs. We rigorously manage our quality assurance processes to ensure consistency and reliability. Our quality controls include strict cleanliness procedures and consistent manufacturing processes. For example, product assembly and testing is done in a temperature and humidity-controlled cleanroom.

Please peruse this manual before installing your White Knight product. It details installation requirements and setup instructions, and provides additional information and accessories to enhance the product's functionality.

Our team has gone to great lengths to ensure our products serve your needs and meet your requirements.

Further, we provide the highest quality products at the best value, and we back them up with excellent warranties and world class support.

Sincerely,

Steve Smith, CEO
White Knight Fluid Handling





1. Product Information

1.1 Specifications & Performance

Model	AP40EXT3	
Max Flow Rate*	14 lpm (3 gpm)	
Displacement Per Cycle*	0.189 liters (0.05 gal)	
Cycles per min	80 max	
Air Connection	1/8, 1/4, or 3/8-in FNPT	
Weight	4.6 kg (10.2 lb)	
Suction Lift*	≤ 1 m (3 ft)	
Sound	Pressure**	70.99 dB(a) at 60 psi 50 CPM 72.53 dB(a) at 60 psi max CPM
	Power**	59.11 dB(a) at 60 psi 50 CPM 60.74 dB(a) at 60 psi max CPM

* May vary by configuration or system. Suction lift diminishes over time. Recommended installation level less than 3 ft above source. To calculate displacement, divide flow rate by CPM.

** Sound measured in accordance with ISO9614-2:1997.

Max Fluid Temperature	100°C (212°F)
Environmental Temperature	min: 0°C (32°F) max: 50°C (122°F)
Max Supply Air Pressure	4 Bar (60 psi)
Min Startup Air Pressure	1.4 bar (20 psi)
Fluid Path Materials	PTFE, PFA
Non-Fluid Path Materials	PTFE, PFA, PP, Ceramic

Stroke Detection	Fiber optic with or without D10 sensor, or solid state pressure switch (NPN or PNP)
Leak Detection	Fiber optic with or without sensor, or conductivity
Electronic Control	CPC, CPT, or custom. Call for details.

AP40EXT3 Performance

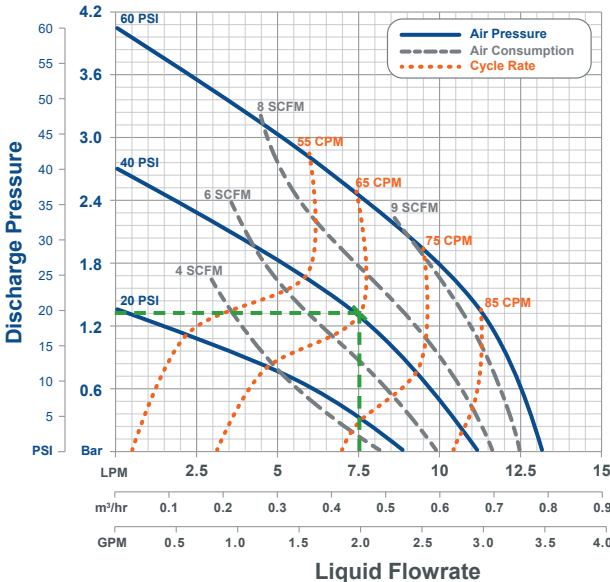

How to Read Charts

Draw horizontal line at your liquid outlet line pressure and vertical line at desired flow rate. At line intersect, estimate required air pressure, resultant cycle rate and air consumption.

Example

See green dashed line. At 1.3 bar (20 psi) liquid outlet line pressure and 40 psi air pressure, AP40EXT3 pumps provide 7.5 lpm (2 gpm) flow rate, cycle at ~65 CPM, and exhaust ~7 SCFM of air.

*Graph is for reference only. Performance was measured utilizing 1/2 in (3/8 in ID) air line and 1-1/4 in (1-1/8 in ID) liquid lines with 1 ft flooded suction. Performance may vary in your system.





1.2 Temperature Limits

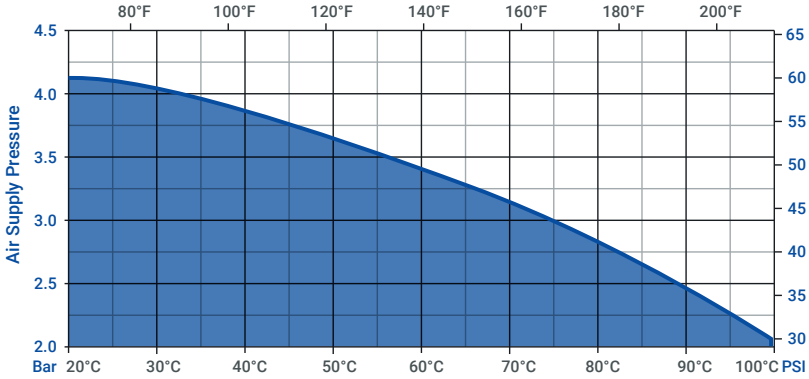

1.3 Dimensions

Dimensions in [mm] in

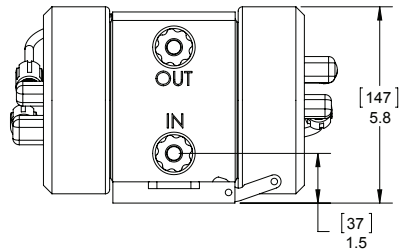
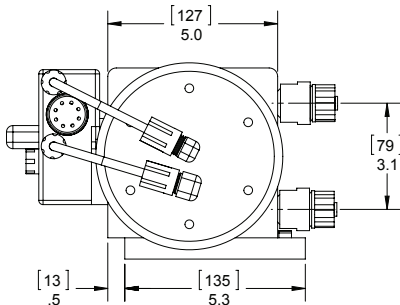
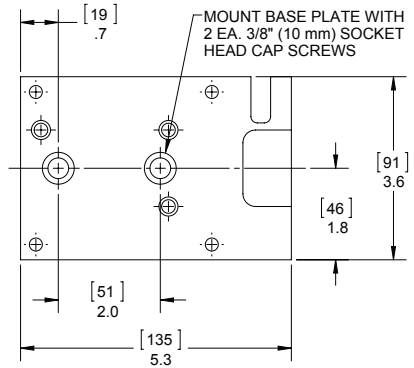
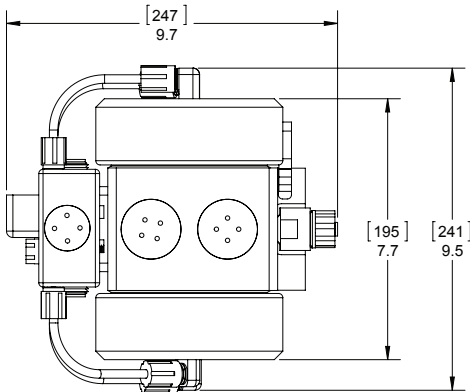



1.4 Bill of Materials

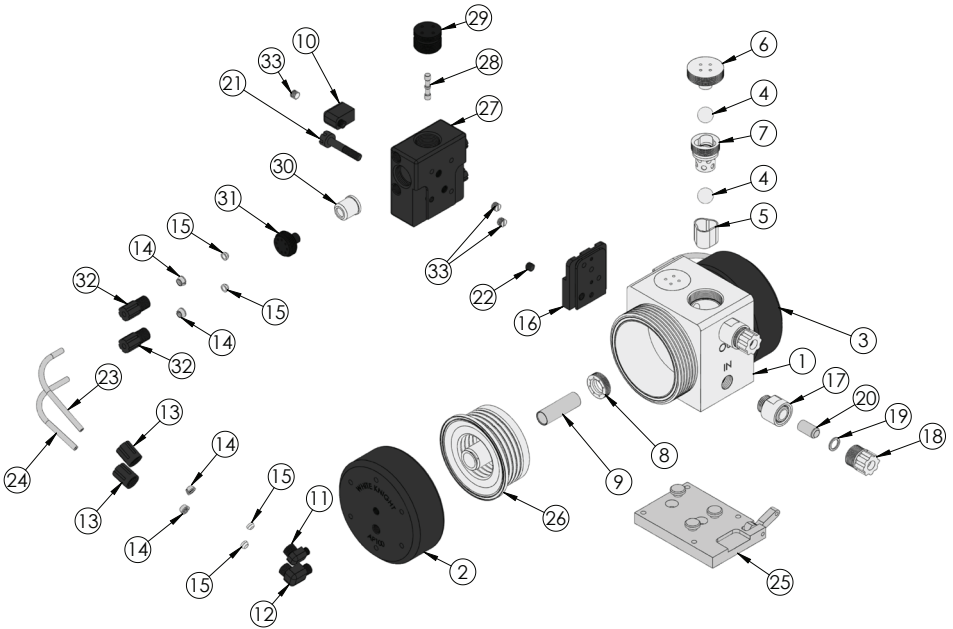

AP40EXT3 BILL OF MATERIALS

ITEM NO.	PART NUMBER	DESCRIPTION	QTY.
1	1125-TE-0001	PUMP BODY	1
2	2127-BP-0003	PUMP HEAD	1
3	2127-BP-0009	HEAD-10GPM LEFT	1
4	4100-TE-0002	CHECK BALL	4
5	4135-TE-0002	BOTTOM CHECK SEAT	2
6	4140-TE-0002	TOP CHECK PLUG	2
7	4142-TE-0003	TOP CHECK CAGE	2
8	5143-TE-0003	SHAFT SEAL	2
9	5144-PF-0002	SHAFT	1
10	6010-BP-0001	1/8" NPT X 1/4" NPT ELBOW	1
11	6030-BP-0001	1/8" NPT X 1/4" GRIPPER ELBOW	2
12	6030-BP-0002	1/4" NPT X 1/4" GRIPPER ELBOW	2
13	6070-BP-0001	FEMALE GRIPPER NUT, 1/4"	4
14	6080-KF-0001	1/4" GRIPPER	8
15	6080-TE-0001	1/4" FERRULE	8
16	6520-BP-0001	SHUTTLE ADAPTER PLATE	1
17	7010-TE-0003	1/2" SYNCHRO BODY-5GPM	2
18	7020-TE-0004	1/2" SYNCHRO NUT	2
19	7040-PF-0002	1/2" SYNCHRO GRIPPER	2
20	7070-PF-0002	1/2" SYNCHRO FLARE NOSE	2
21	10010-BP-0001	SCREW SET SHUTTLE	1
22	10010-BP-0004	ADAPTER BASE PLATE SCREW	1
23	10071-PF-0008	THICK-WALL TUBING, 1/4"	2
24	10071-PF-0009	THIN-WALL TUBING, 1/4"	2
25	14200-NP-0002	BASE PLATE ASSEMBLY	1
26	14300-PF-0002	BELLOW ASSEMBLY	2
27	14400-BP-0002	SHUTTLE BODY AND SLEEVE	1
28	6560-CE-0001	CERAMIC SPOOL- 5 GPM	1
29	6530-BP-0002	SHUTTLE END CAP- 5GPM	2
30	6140-TE-0001	WHISPER MUFFLER INSERT-5GPM	2
31	6150-BP-0001	WHISPER MUFFLER CAP-5GPM	2
32	6070-BP-0005	1/4" MALE GRIPPER NUT	4
33	10040-TE-0002	1/8" NPT Plug	3





2. Installation

2.1 Precautions

Handling

Do NOT lift pump by shuttle valve assembly nor air tubing.

Installation Orientation

AP40EXT3 pumps must be installed in an upright position. The check valves are actuated by gravity and/or flow, and they will not seat if the pump is not upright.

Timer Mode

AP40EXT3 pumps require an end of stroke detection mechanism (pressure switch) to prevent over stroking in timer mode. Operating a AP40EXT3 in timer mode without stroke detection will void the pump warranty.

Required Air Flow (Shuttle Valve)

AP40EXT3 pumps require 1/4 in minimum orifice with unrestricted air flow.

Required Air Flow (Solenoid Valve)

AP40EXT3 pumps require a 0.75 Cv solenoid. Using a reduced Cv will reduce flow rates. Using a valve with more than 20% greater Cv will change operating parameters, reduce pump life and void the warranty.

Under Supply of Air

AP40EXT3 pumps operate erratically or stall when air supply is insufficient. Ensure use of air supply pressures higher than averaged air consumption lines in performance charts. Air supply lines and fittings must meet minimal inner diameter requirements shown in the installation instructions.

Air Supply Pressure

Operating AP40EXT3 pumps ~35% below max air pressure may significantly extend pump life. AP40EXT3 pumps require 20 psi minimum air pressure. Operation above 4 Bar (60 psi) may damage the pump and void the warranty.

Suction Lift

AP40EXT3 pumps have an initial suction lift capacity of 3 ft. For best results minimize suction lift.

Liquid Inlet/Outlet Connections

AP40EXT3 liquid ports are not NPT nor any other standard. Use of connectors other than those supplied by White Knight will damage the pump and void the warranty.

Liquid Line Restriction

AP40EXT3 pumps may be controlled by closing liquid outlet lines. However, restricting liquid supply lines increases wear and should be avoided. Do NOT pump against a closed liquid inlet. It will damage the pump and void the warranty.

Running Dry

AP40EXT3 pumps use the pumped liquid to lubricate their shafts. The pumps will cycle faster and wear more than normal when run dry, which may cause damage and loss of self-prime abilities. AP40EXT3 pumps should not run dry after start-up and are not warranted under dry run conditions.

Pulse Dampener with Shuttle Valve

Air supply pressure to AP40EXT3 pumps should be at least ten psi higher than the liquid line pressure when using a pulsation dampener. Failure to do so may cause erratic operation.

Cross Contamination

AP40EXT3 pumps use porous material that may retain chemicals. Take precautions to avoid cross contamination.



2.2 Warnings

Pressurized Material



Pumps in use contain pressurized materials. Eliminate liquid and air pressure via shut off valves before pump is detached or removed from the system.

High Temperature



Heat may transfer to exterior surfaces when pumps operate with high temperature fluids. Avoid direct contact with the pump when high temperature fluids are present.

Hazardous Chemical



Use appropriate personal protective equipment when handling pump. Reference Material Safety Data Sheet (MSDS) for information specific to your chemicals.

Loud Noise



Pump exhaust air contributes to work area noise levels. Only operate pumps with approved muffler media, and use ear protection in noisy conditions.

2.3 Advantages

Head Pressure / Dead-Head

AP40EXT3 pumps can be controlled by adjusting their liquid outlet pressures and can be installed with head pressures up to dead-head (e.g. equal liquid and air pressures) with no damage to the pump.

Thermal Cycling

AP40EXT3 pumps require no maintenance when operated within their performance range, even in thermal cycling applications.

2.4 Environment & System

Oversized Inlet Line

Pumps operate optimally with liquid inlet lines larger than the liquid outlet lines. This reduces strain on the bellows and may reduce pulsation in the pump outlet.

Clean Supply Air (CDA)

AP40EXT3 pumps require use of Class 2 air for particles and moisture per ISO 8573-1. Use 10 micron filter; maintain -40°C dew point. A point-of-use filter is recommended during first six months of operation in new fabs/systems due to high risks of debris that can damage pumps and void warranty.

Flammable Solvents

AP40EXT3 pumps are not constructed from conductive materials. System that pump flammable solvents should be properly grounded to avoid ignition by static charge. A River's Edge test of isolative pumps with flammable liquids indicated that liquids must be grounded and other procedures should be followed. Copy of test available.

Pumping Liquids Near Boiling Point

Minimizing suction lift reduces pulsation and the potential for boiling or outgassing of liquid in the inlet of the pump. Although reciprocating pumps can pull suction lift, pump performance and life increase when suction lift is minimized or eliminated.

Abrasive Slurry

Pumping abrasive slurry may accelerate wear of components. AP40EXT3 pumps are warranted when used with slurry. However, normal wear is not covered by warranty.

Environmental Temperature

AP40EXT3 pumps are rated for 0°C (32°F) - 50°C (122°F) environmental temperatures. Do not freeze fluid in pump. Operation below 0°C may accelerate wear. Normal wear is not covered by warranty.



2.5 Installation Instructions

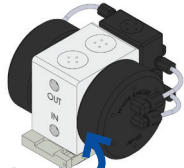

1. Move lever to up position.

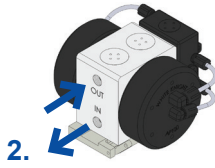

2. Slide base plate forward or pump body backward.

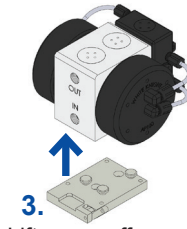

3. Lift pump off of base plate.

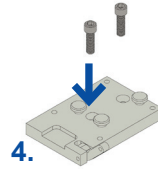

4. Screw base plate to surface with 3/8 in or 10 mm socket head cap screws into pre-drilled holes.

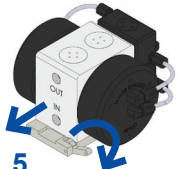

5. Set pump on base knobs; slide it forward. Set lever to down position.

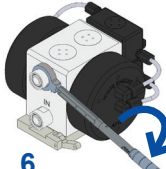

6. Attach fittings to pump. Tighten to 20 inch-lbs.

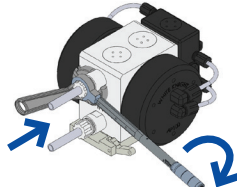

7. Attach tubes and fittings per manufacturer instructions. Use backer wrench to hold fitting in place at pump.

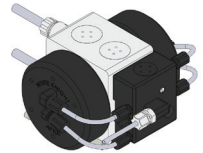

8. Affix supply air via 1/4 in FNPT port on shuttle valve. Air line must be 3/16 in minimum orifice.

Liquid Inlet/Outlet

Liquid ports are not NPT nor any other standard. Use of connectors other than those supplied by White Knight will damage the pump.





2.6 Shuttle Service Instructions

Follow instructions below to inspect or service White Knight shuttle valves. If a pump has stopped, ensure all recommendations in this manual are followed and that there are no air supply issues (i.e. closed air valve, damaged regulator, oil in air line, etc.).

Do not lubricate or oil any of the shuttle components. White Knight shuttle valves do not require any lubrication.

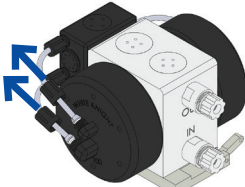

1. Remove nuts on each air fitting on each pump head.

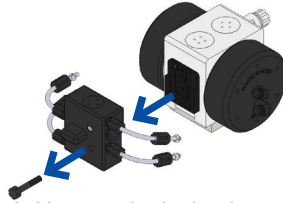

2. Unscrew both shuttle mounting bolts, and pull the shuttle from the pump.

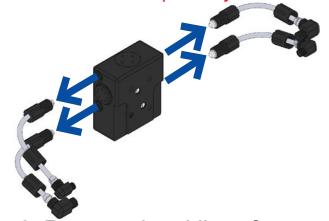

3. Remove the airlines from both sides of the shuttle valve by unscrewing the air fittings.

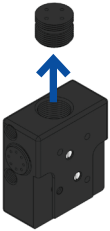

4. Unscrew top shuttle end cap using the shuttle end cap tool.

Part: 12100-PV-0083

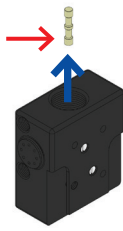

5. Carefully remove ceramic spool from shuttle valve; it may break if dropped.

If the ceramic spool in your pump has a flat feature, it is critical that it is oriented towards the bottom of the pump when the shuttle valve is reassembled.

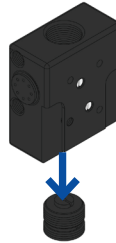

6. Unscrew bottom end cap using the shuttle end cap tool.

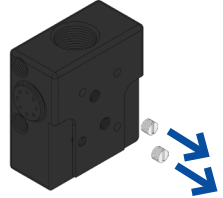

7. Unscrew both 1/8 in NPT plugs that have an orifice in the center.

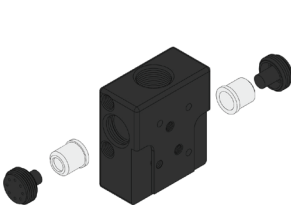

8. Remove muffer cap from left side using the muffer cap tool. Remove muffer media and note the order of the pieces. Repeat this step for muffer cap and muffer media on the right side.

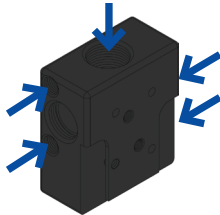

9. Blow out shuttle valve with CDA or N2. Ensure no residue or debris is in any areas indicated above. Debris or residue in these areas may hinder pump performance.



10. Clean the ceramic spool with IPA, and dry it using CDA or N2.

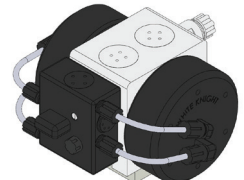

11. Reassemble shuttle and reattach it to the pump by following the above steps in reverse.
If the spool in your pump has the flat feature, ensure it is oriented towards the bottom of the pump when the shuttle valve is reassembled.





3. Pump Service

3.1 Ordering Instructions

Standard Configuration: AP40EXT3-AAAA-AAAA-AAB

AP40EXT3 - Standard model
with 3-year extended warranty

- A - Front Straight Liquid Inlet Style
- A - Front Straight Liquid Outlet Style
- A - 1/2 in. Synchro-Flare Liquid Inlet
- A - 1/2 in. Synchro-Flare Liquid Outlet

- A - 1/4 in. FNPT EII Air Supply Inlet
- A - Ceramic Shuttle Valve with Internal Mufflers
- A - Whisper Non-adjustable Muffler
- A - No Pulse Dampener

- A - No Stroke Detection
- A - No Leak Detection
- B - Lever-Lock Base Plate

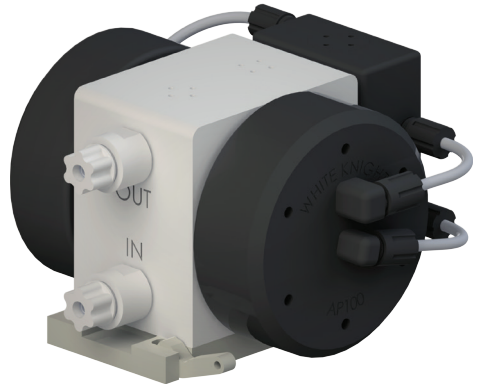

Catcher™ Pre-Filter Accessory: PFII050-A

White Knight Catcher™ pre-filters protect pumps from wafer shards and other harmful solids. They can be cleaned without disconnecting liquid lines. The PFII050-A is the standard pump-mounted model for 30 lpm (8 gpm) pumps. It has a 0.043-in screen orifice and 1/2 in. Synchro-Flare fittings.

<https://wkfluidhandling.com/catchers/>





3.2 Rebuild Information

Pumps fully rebuilt by White Knight, certified rebuilders, or technicians certified by White Knight receive full warranty renewal. Details below.

White Knight Rebuilds

Request factory rebuilds by web form at: <https://wkfluidhandling.com/support/rma/>. An RMA# will be provided after processing.

**Customers must follow decontamination instructions in Section 4.4 when returning a pump to White Knight.*

Certified Rebuilders

White Knight's global network of certified rebuilders expedite rebuild turn-around time and minimize shipping costs. Find certified rebuilders at: <https://wkfluidhandling.com/rebuilders/>

Rebuild Pump as Certified Technician

White Knight offers trainings to certify technicians to rebuild pumps. Technicians who pass the training are issued a two-year certification. During the two years, parts in pumps rebuilt by the technician receive a full warranty. See: <https://wkfluidhandling.com/virtual-rebuilds/>

4.3 Rebuild Kits & Parts

Rebuild kit for AP40EXT3 is RBAPX403-1. To request rebuilds by White Knight, use RBAPX403-5 (labor included). Pump rebuilds require tool kit: 12200-XX-0019 (Legacy# AP40EXT3-170).

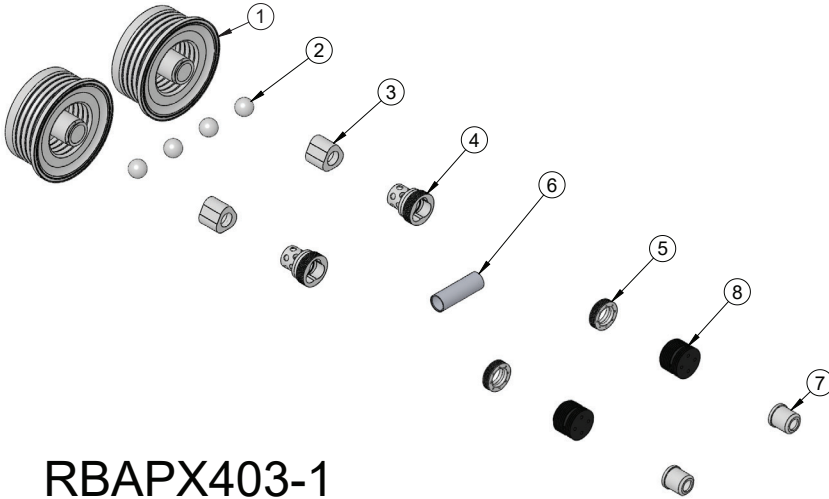

RBAPX403-1

ITEM NO.	PART NUMBER	DESCRIPTION	QTY.
1	14300-PF-0002	BELLOWS ASSEMBLY	2
2	4100-TE-0002	CHECK BALL	4
3	4135-TE-0002	BOTTOM CHECK SEAT	2
4	4142-TE-0003	TOP CHECK CAGE	2
5	5143-TE-0003	SHAFT SEAL	2
6	5144-PF-0002	SHAFT -10GPM	1
7	6140-TE-0001	Whisper® Muffler	2
8	6530-BP-0002	SHUTTLE END CAP- 5GPM	2





3.4 Return Pump for Service

Follow decontamination instructions when returning a pump for service.

DO NOT REMOVE PAGE FROM MANUAL.

Copy page from manual or download at <https://wkfluidhandling.com/support/rma/>.

Decontamination Instructions

PRINT COMPLETED DECONTAMINATION CERTIFICATION. IT MUST BE INCLUDED IN YOUR RMA SHIPMENT.

White Knight products are designed for use with caustic and otherwise dangerous liquids. Handle every product as if it contains dangerous chemicals whether or not it actually does.

- Only those with adequate safety training should attempt to handle used pumps.
- Wear adequate safety gear appropriate for chemicals that have been in the pump.
- Review relevant Material Safety Data Sheets (MSDS) before handling the pump.
- Review emergency numbers for use in event of an accident.
- Prepare Ph papers, showers, antidotes, clean-up equipment, neutralizers, and other safety devices used to detect, neutralize or minimize effects of chemicals described in appropriate MSDS documents.

Rinse with DI Water

Circulate DI water through pump for twenty minutes before disassembly and/or double bagging for shipment. If pump is nonfunctional, force DI water from inlet through outlet for 40 minutes before shipment preparations.

Remove Pump from Station:

1. Disconnect liquid tubing connectors from front of pump (opposite shuttle valve).
2. Plug NPT fittings with PTFE plug, Flare fittings with flare nose cover and cap, or other plug or cap as recommended by connector supplier.
3. Disconnect air supply tubing from face of shuttle valve.
4. Loosen mount screw from base plate. (Note: do not remove screw from base plate).
5. Remove base plate using proper tool for the fastening devices (e.g. Allen wrench or screw driver). Note: Base plate may stay if needed for replacement pump to be used.
6. Return all removed parts to the pump.

Return Pump to White Knight:

1. Rinse pump with DI water as described above after removing it from its station.
2. Drain remaining DI water from the pump inlet and outlet liquid tubing connectors.
3. Plug liquid outlets as described in the Remove Pump from Station section above.
4. Dry the pump, double bag it, and seal it in thick polyethylene bags.
5. Return the pump to its original packaging.
6. Include MSDS for the chemical that the pump was handling in the box with the pump.
7. Obtain RMA number from White Knight and write it on the outside of the box.
8. Ship to White Knight following all rules, regulations and laws regarding shipment of dangerous materials. Ship freight pre-paid. No collect shipments will be accepted. Unauthorized use of White Knight shipping accounts will result in the adding of freight to the bill in addition to a service charge.

Include All Pump Components:

Pumps returned to White Knight for evaluation, service or repair must be complete with all components, including but not limited to base plate, mount screws, tubing connectors, tubing connector caps, flare noses, shuttle valves, mufflers, and tubing. Missing parts will be added to the pump and charged to the customer.





DO NOT REMOVE PAGE FROM MANUAL.

Copy page from manual or download at <https://wkfluidhandling.com/support/rma/>.

Decontamination Certification

COMPLETE AND PRINT THIS FORM. IT MUST BE INCLUDED IN YOUR RMA SHIPMENT.

I, the undersigned employee of _____, certify that all decontamination and safety procedures described in Decontamination Instructions section have been followed for return of product below.

RMA#: _____

(We cannot process returns without an RMA number.)

Serial#: _____

(We cannot process returns without a product serial number.)

Metal Exposure:

(Check all that apply. Write in other metals if necessary.)

Product was used in a Metal Process. Yes No

Product was used in a Copper Metal Process. Yes No

Product was used with:

- Aluminum Cobalt Gold Lead Nickel Platinum Silver Tin Titanium
- Tungsten Zinc Other: _____

Chemical Exposure:

(Check all that apply. Write in other chemicals if necessary.)

Product was **NOT** used in chemicals (DI Water only).

Product was used in chemicals.

- Ammonia Ammonium Hydroxide Hydrochloric Acid Hydrofluoric Acid Hydrogen Peroxide IPA
- Nitric Acid Phosphoric Acid Sulfuric Acid Other: _____

Shipping Information:

Please indicate metal processes to which the product has been exposed by clearly and conspicuously labeling the outside of the return package with the metal.

Products exposed to Metal Processes must be sent to the following address:

White Knight Fluid Handling
187 East 670 South, Suite B
Kamas, UT 84036

Products NOT exposed to Metal Processes must be sent to the following address:

White Knight Fluid Handling
187 East 670 South, Suite C
Kamas, UT 84036

Print Name: _____

Signature: _____

Date: _____





4. Warranty

White Knight Fluid Handling follows strict procedures in all phases of manufacturing, assembly and testing to ensure reliability of its products. Each pump is individually tested to assure its functional operation integrity.

White Knight Fluid Handling warrants pumps, subassemblies and components to be free from defects in materials and workmanship for the period of one year from the date of start-up or 18 months from the date of shipment, whichever applies. Failures due to misuse, abuse or any unauthorized disassembly of a White Knight pump could nullify this warranty.

Some pumps carry additional warranty coverage, for instance, EXT Series pumps carry two or three year warranties depending on the version of pump. The AP40EXT3 carries a three year warranty.

The Facilitator Series pumps are warranted for up to 100 psi air supply (when using a secondary shift air source at 50 psi) and have no limitations on running dry or on running abrasive slurries.

All variations of AP, AT, X, and APFM as well as EXT models are only covered up to 60 psi of air supply pressure, are not covered under dry run conditions, and are not covered in the event of running abrasive slurry.

Due to the broad and ever evolving applications for usage of White Knight pumps we cannot guarantee the suitability of any pump, component, or subassembly for any particular or specific application. White Knight Fluid Handling shall not be liable for any consequential damage or expense arising from the use or misuse of its products in any application. Responsibility is limited solely to the replacement or repair of defective White Knight pumps, components, or subassemblies. All options to rebuild or replace aforementioned items shall remain under the judgment of White Knight Fluid Handling. Decisions as to the cause of failure shall be solely determined by White Knight Fluid Handling.

Prior written, faxed, or emailed approval must be obtained from White Knight Fluid Handling before returning any pump, component, or subassembly for warranty consideration.

THE FOREGOING WARRANTY IS EXCLUSIVE AND IN LIEU OF ALL OTHER WARRANTIES EXPRESSED OR IMPLIED INCLUDING ANY WARRANTIES OF SUITABILITY FOR ANY PARTICULAR PURPOSE. NO VARIATIONS OF THIS WARRANTY BY ANYONE OTHER THAN THE PRESIDENT OF WHITE KNIGHT FLUID HANDLING IN A SELF SIGNED AGREEMENT SHALL BE HONORED OR CONSIDERED LEGAL BINDING.

Steve Smith, CEO
White Knight Fluid Handling





Barclay Phelps CE Marking Consultants
29/8 City Mill Lane, Gibraltar 646, Europe

CERTIFICATE & DECLARATION OF CONFORMITY FOR CE MARKING

Company contact details:

White Knight Fluid Handling Inc.
187 E. 670 S., Kamas, Utah 84036, USA
Tel: 435-783-6040 Fax: 435-783-6128 Email: Info@Whiteknightpumps.com

White Knight Fluid Handling Inc. declares that their Pumps listed herewith:

AP40EXT3, AP50, APFM50, X50, PL30, AT50,
AP100, APFM100, X100, PL60, AT100, AP200,
APFM200, AP300, APFM300, PL120 and AT300HD

are classified within the following EU Directive:

EU Machinery Directive 98/37/EC & 2006/42/EC

and further conform with the following EU Harmonized Standard:

EN 809:1998 Pumps and pump units for liquids. Common safety requirements

Dated: 09 June 2009

Position of signatory: Vice President

Name of Signatory: David Michael Simmons

Signed:

p.p. White Knight Fluid Handling Inc.





**WHITE
KNIGHT®**

.....*engineer approved™*

White Knight Support

187 E. 670 S.
Kamas, UT 84036

Phone: 435.783.6040
Toll Free: 888.796.2476
Fax: 435.783.6128

support@wkfluidhandling.com
<https://wkfluidhandling.com/support/>



Part No. 18200-LM-0079



Copyright © 2022 White Knight Fluid Handling | A Graco company
P: 435.783.6040 | support@wkfluidhandling.com | <https://wkfluidhandling.com>

Version 1.0.3 | 25 May 2022
Subject to change without notice