

# **APPENDIX E**

---

## **EFECTOR**

### **CAPACITIVE LIQUID LEVEL SENSORS**

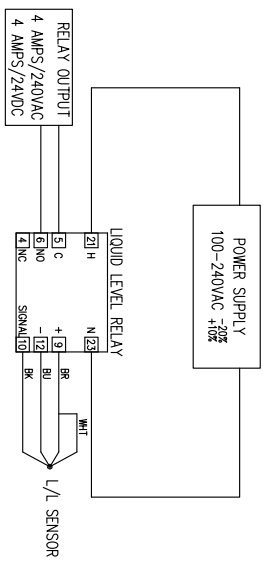

WIRING DIAGRAM

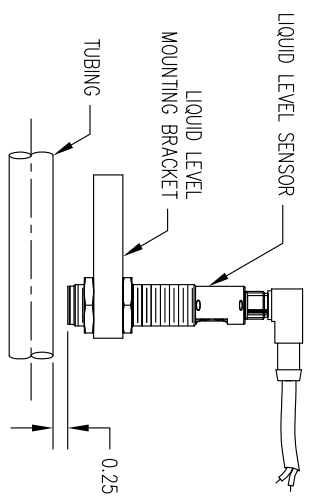

MOUNTING

FIGURE 1:

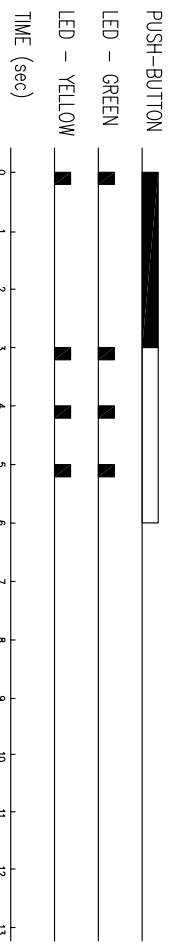
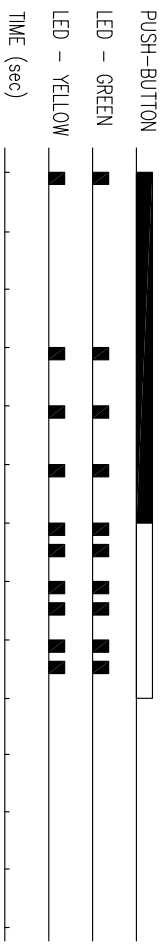

FIGURE 2:



NOTE:  
 1. ADJUSTMENT - BACKGROUND  
 -PRESS PUSH-BUTTON ON THE SENSOR UNTIL LED'S ARE FLASHING ONE TIME PER SECOND. THE BACKGROUND WILL BE CALIBRATED WHEN THE PUSH-BUTTON IS RELEASED DURING THE FOLLOWING 3 SECONDS. (SEE FIGURE 1)

2. ADJUSTMENT - OBJECT  
 -PRESS PUSH-BUTTON ON THE SENSOR UNTIL LED'S ARE FLASHING TWO TIMES PER SECOND. THE OBJECT WILL BE CALIBRATED WHEN THE PUSH-BUTTON IS RELEASED DURING THE FOLLOWING 3 SECONDS. (SEE FIGURE 2)

3. THE LIQUID LEVEL SENSOR CAN BE NORMALLY OPEN OR NORMALLY CLOSED. IT MUST OPERATE UNDER NORMALLY OPEN.

CONFIDENTIALITY THIS DRAWING & THE INFORMATION CONTAINED THEREIN IS CONFIDENTIAL & PROPRIETARY TO HEATEFLEX CORPORATION. IT IS NOT TO BE REPRODUCED IN ANY MANNER, NOR USED FOR ANY PURPOSE, WITHOUT THE WRITTEN AUTHORIZATION OF HEATEFLEX CORPORATION.		UNLESS OTHERWISE NOTED, DIMENSIONS & TOLERANCES ARE IN INCHES (MILLIMETERS) & PER ANSI-Y14.5 & RELATED CORP. DRAWING STANDARDS.	
DRAWN BY: R. Mendoza CHECKING SC:	DATE: 04/03/19	ENG/ISSN:	DATE:
APPROVED BY:	DATE:	DWG. NO.: LHX457	REV: 00
SHEET: B OF 1	SCALE: NONE	FILE: LHX457	
TITLE: SCHEMATIC DIAGRAM LIQUID LEVEL SENSOR (30774 & 30776/7A) IN-LINE HEATER SERIES			

Capacitive sensors

**KG5025**

KG-3008-FNKG/NI  
Capacitive sensor  
Plastic thread M18 x 1  
Cable

Increased immunity to conducted  
radio frequency interference

Sensing range 8mm [nf]  
adjustable 2.5...8 mm  
non-flush mountable

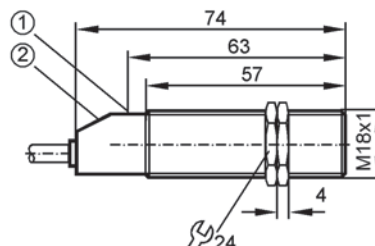

1: Programming button  
2: 3 LED



<b>Electrical design</b>	
<b>Output</b>	
Operating voltage	[V]
Current rating	[mA]
Short-circuit protection	
Reverse polarity protection	
Overload protection	
Voltage drop	[V]
Current consumption	[mA]
Switch-point drift	[% of Sr]
Hysteresis	[% of Sr]
Switching frequency	[Hz]
Correction factors	
Operating temperature	[°C]
Protection	
EMC	
Housing material	
Function display	
Switching status	LED
Operation	LED
Function	LED
Connection	
Accessories (included)	

<b>DC NPN</b>	
<b>normally open / closed programmable</b>	
	10...36 DC
	250
	pulsed
	yes
	yes
	< 2.5
	< 30 (24 V)
	-15...15
	1...15
	40
water = 1 / glass approx. 0.4 / ceramics approx. 0.2 / PVC approx. 0.2	
	-25...80
	IP 65, II
	EN 60947-5-2
	PBT
	yellow
	green
	red
PVC cable / 2 m; 3 x 0.34 mm <sup>2</sup>	
2 lock nuts, screwdriver	

**Wiring**

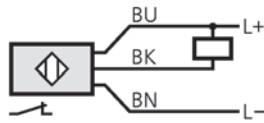
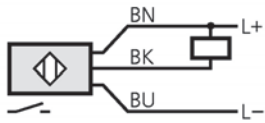

ifm electronic gmbh • Teichstraße 4 • 45127 Essen — We reserve the right to make technical alterations without prior notice. — GB — KG5025-AE — 09/06.2004



ifm electronic

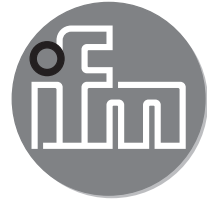

**Bedienungsanleitung  
Operating instructions  
Notice pour utilisateurs**

**efector150<sup>®</sup>**

**Kapazitiver  
Näherungsschalter  
KG/P**

**Capacitive proximity  
switch KG/P**

**Détecteur de proximité  
capacitif KG/P**

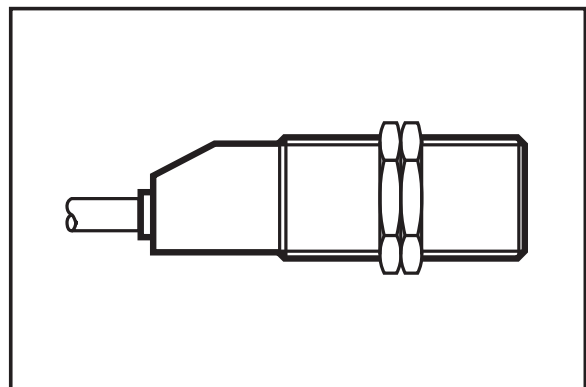

Sachnr. 701294/00 02/2006

## Function and features

This proximity switch detects metals, almost all plastics, glass, ceramics, wood, paper, oils, greases, water and all hydrous materials without contact and indicates their presence by providing a switched signal.

- Nominal sensing range ( $S_n$ ) 8 mm (measured on an earthed metal plate and water; a shorter sensing range for other materials).
- Automatic adjustment to the medium to be detected.

## Installation

Mount the unit by means of a mounting device. Secure it by means of the nuts provided so that it cannot work loose.

Non-flush installation.

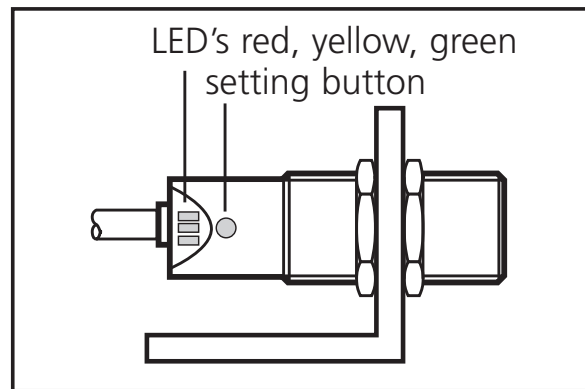

Open space around the sensing face:

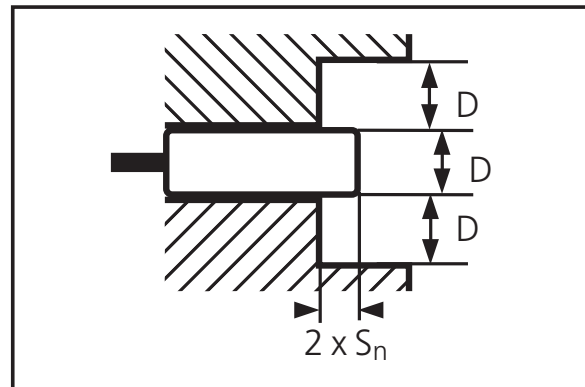
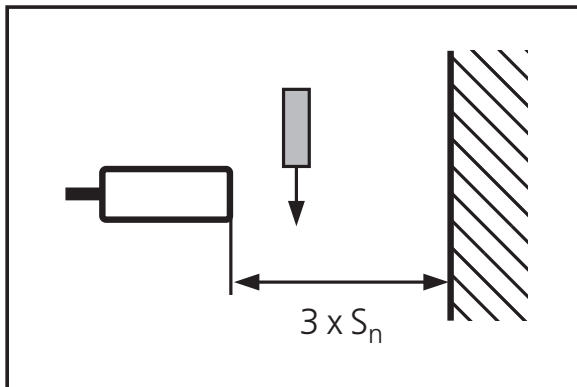

Minimum distance when several switches of the same type are mounted:

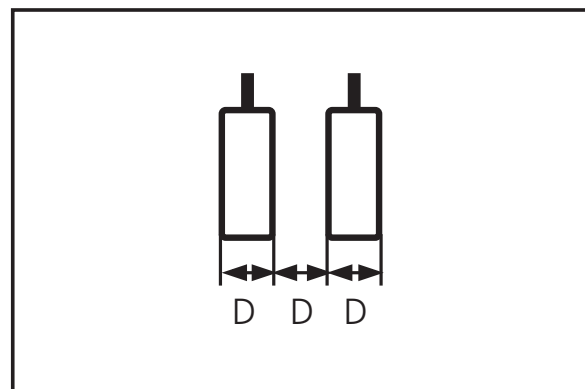
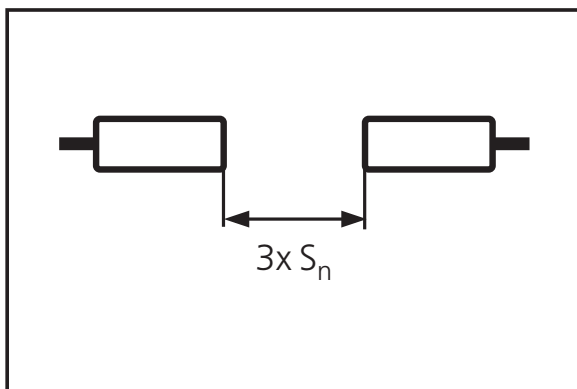

## Electrical connection





Disconnect power before connecting the proximity switch.  
 Connection strictly to the indications on the type label.

Core colours: BN = brown, BU = blue, BK = black.

## Adjustment

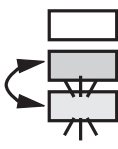
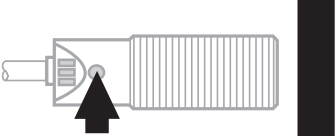
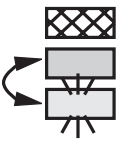
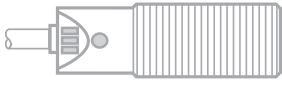
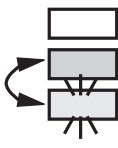
The unit detects the "damped" state (= medium present) and the "undamped" state (= no medium present) and sets the optimum switch point.

1	 Press for 5s.	→	 Yellow and green LEDs flash alternately (= unit is in the programming mode).
2	 Place the medium into the detection area of the sensor and press the button briefly.	→	 The yellow and green LED's go out for a short time, then quickly flash alternately; <b>the red LED is on.</b>
3	 Remove the medium and increase the distance between the medium and the unit until the red LED goes out.	→	 The yellow and green LED's continue to flash alternately. <b>The red LED goes out.</b>
If the red LED does not go out, the interval between the "damped" and the "undamped" signals is too short. Press the setting button twice. The unit passes into the operating mode with the switch point being unchanged..			
4	 Press briefly.	→	 The yellow and green LED's go out for a short time, then the green LED is on (= unit is in the operating mode).





Steps 2 and 3 can also be taken in reverse order: first align the unit without the medium being present and then place the medium into the detection area until the red LED goes out.

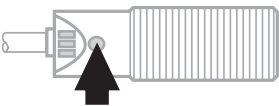

If the setting of the switch point is not possible (the signals for damped/undamped follow too close), the red LED flashes after step 4 (= adjustment error). Press the setting button once. The unit then passes into the operating mode with the switching point being unchanged.

## Locking / Unlocking

The unit can be electronically locked to prevent unwanted adjustment of the set parameters:

 Press for 10s.		The yellow and green LED's flash alternately; after 10s the LEDs go out, the unit is locked.
 Press for 10s.		After 10s the LED's go out, locking is annulled.

## Operation

Check the safe functioning of the switch.

The operation of the proximity switch is maintenance-free. For perfect functioning make sure that:

- the sensing face and the open space are kept free of deposits and foreign bodies, particularly for installation with the sensing face facing upwards.

LED display:

LED green lights	unit is ready for operation.
LED yellow lights	output is switched.
LED red lights	uncertain working range.
LED red flashes	internal malfunction, adjustment error.
LED's yellow + red	simultaneous flashing: output is short-circuited.



ifm electronic

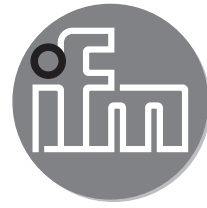

Operating instructions

**ecomat200**<sup>®</sup>

Switching amplifier

DN0210

DN0220

UK

80011079 / 00 01 / 2015

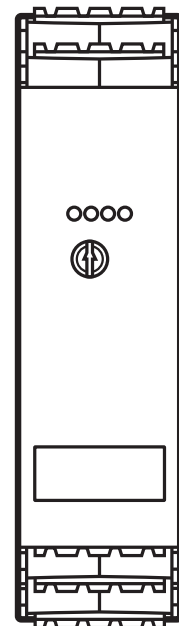

# Contents

1	Preliminary note.....	4
1.1	Symbols used .....	4
1.2	Warning signs used .....	4
2	Safety instructions .....	5
2.1	General.....	5
2.2	Target group.....	5
2.3	Electrical connection.....	5
2.4	Handling .....	6
2.5	Installation location .....	6
2.6	Housing temperature .....	6
2.7	Tampering with the device .....	6
3	Functions and features .....	7
4	Operating and display elements .....	8
4.1	LEDs.....	8
4.2	Potentiometer .....	8
5	Installation.....	9
5.1	Installation of the device .....	9
5.1.1	Remove the device.....	9
5.2	Mounting of the sensors .....	9
6	Electrical connection.....	10
6.1	Connection accessories .....	10
6.2	Terminal connection.....	10
6.3	Voltage supply (power).....	11
6.3.1	AC supply .....	11
6.4	Inputs.....	12
6.4.1	Connection of the sensors.....	12
6.5	Outputs .....	12
6.5.1	Relay outputs.....	12
7	Settings.....	13
7.1	Switching diagram .....	13
8	Scale drawing .....	14
9	Technical data.....	14

9.1 Approvals/standards .....	15
10 Troubleshooting .....	16
11 Maintenance, repair, disposal .....	16
11.1 Maintenance .....	16
11.2 Cleaning the housing surface .....	16
11.3 Repair .....	16
11.4 Disposal .....	16

**UK**

# 1 Preliminary note

This document applies to switching amplifiers DN0210 and DN0220.

The devices differ in the following points:

number of input/output channels → see type label.

This document is intended for specialists. These specialists are people who are qualified by their training and their experience to see risks and to avoid possible hazards that may be caused during operation, installation or maintenance of the device.

Read this document before use to familiarise yourself with operating conditions, installation and operation. Keep this document during the entire duration of use of the device.

## **WARNING**

Adhere to the warning notes and safety instructions (→ 2 Safety instructions).

### 1.1 Symbols used

▶ Instructions

> Reaction, result

[...] Designation of keys, buttons or indications

→ Cross-reference



Important note

Non-compliance can result in malfunction or interference.



Information

Supplementary note.

### 1.2 Warning signs used

#### **WARNING**

Warning of serious personal injury.

Death or serious irreversible injuries may result.

#### **CAUTION**

Warning of personal injury.

Slight reversible injuries may result.

**NOTE**

Warning of damage to property.

## 2 Safety instructions

### 2.1 General

Follow the operating instructions. Non-observance of the instructions, operation which is not in accordance with use as prescribed below, wrong installation or incorrect handling can affect the safety of operators and machinery.

**UK**

The installation and connection must comply with the applicable national and international standards. Responsibility lies with the person installing the device.

The system installer is responsible for the safety of the system into which the device is integrated.

### 2.2 Target group

The device must only be installed, connected and put into operation by a qualified electrician.

### 2.3 Electrical connection

Disconnect the unit externally before handling it. Also disconnect any independently supplied relay load circuits.

The wiring of all signals in connection with the SELV circuit of the device must also comply with the SELV criteria (safety extra-low voltage, safe electrical isolation from other electric circuits).

If the externally supplied or internally generated SELV voltage is externally grounded, the responsibility lies with the user in accordance with the applicable national installation regulations. All statements in these operating instructions refer to the unit the SELV voltage of which is not grounded.

It is not allowed to supply external voltage to the terminals for the pulse pick-up supply. The consumption of current which exceeds the value given in the technical data is not allowed.

An external main switch must be installed for the unit which can switch off the unit and all related circuits. This main switch must be clearly assigned to the unit.

## **2.4 Handling**

Be careful when handling the unit once power is applied. This is only allowed by qualified personnel due to the protection rating IP 20.

## **2.5 Installation location**

For the correct operation the device must be mounted in a housing which can only be opened using a tool or in a locked control cabinet (both protection rating IP 54 or higher) as an enclosure in accordance with EN 61010.

## **2.6 Housing temperature**

As described in the technical specifications below the device can be operated in a wide ambient temperature range. Because of the additional internal heating the operating elements and the housing walls can have high perceptible temperatures when touched in hot environments.

## **2.7 Tampering with the device**

In case of malfunction of the unit or queries please contact the manufacturer. Any tampering with the device can seriously affect the safety of operators and machinery. This is not permitted and leads to the exclusion of any liability and warranty claims.

### 3 Functions and features

The switching amplifier is used for power supply and signal evaluation of PNP/NPN switching sensors or mechanical contacts. Relay outputs 1 and 2 are switched without delay by the input signals 1 and 2 (number of input/output channels depends on device variant).

Each input channel is equipped with an independent overload/short circuit protection mechanism. When an overload or a short circuit has been removed, each input channel automatically returns to normal operation.

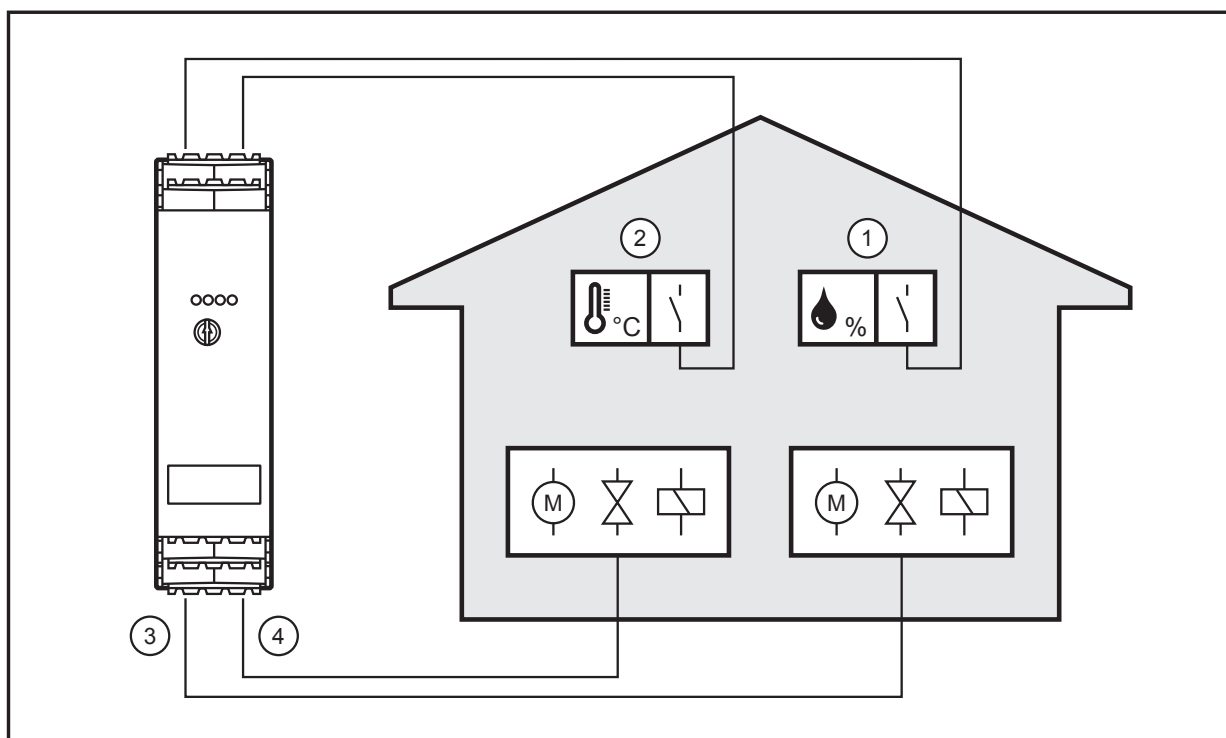

UK

Example: DN0220 (2-channel)

- 1: Humidity sensor with switching output for input signal 1
- 2: Temperature sensor with switching output for input signal 2
- 3: Relay output 1 for switching electric motors, valves, etc.
- 4: Relay output 2 for switching electric motors, valves, etc.

#### **⚠ WARNING**

The device is not approved for safety-related tasks in the field of operator protection.

## 4 Operating and display elements

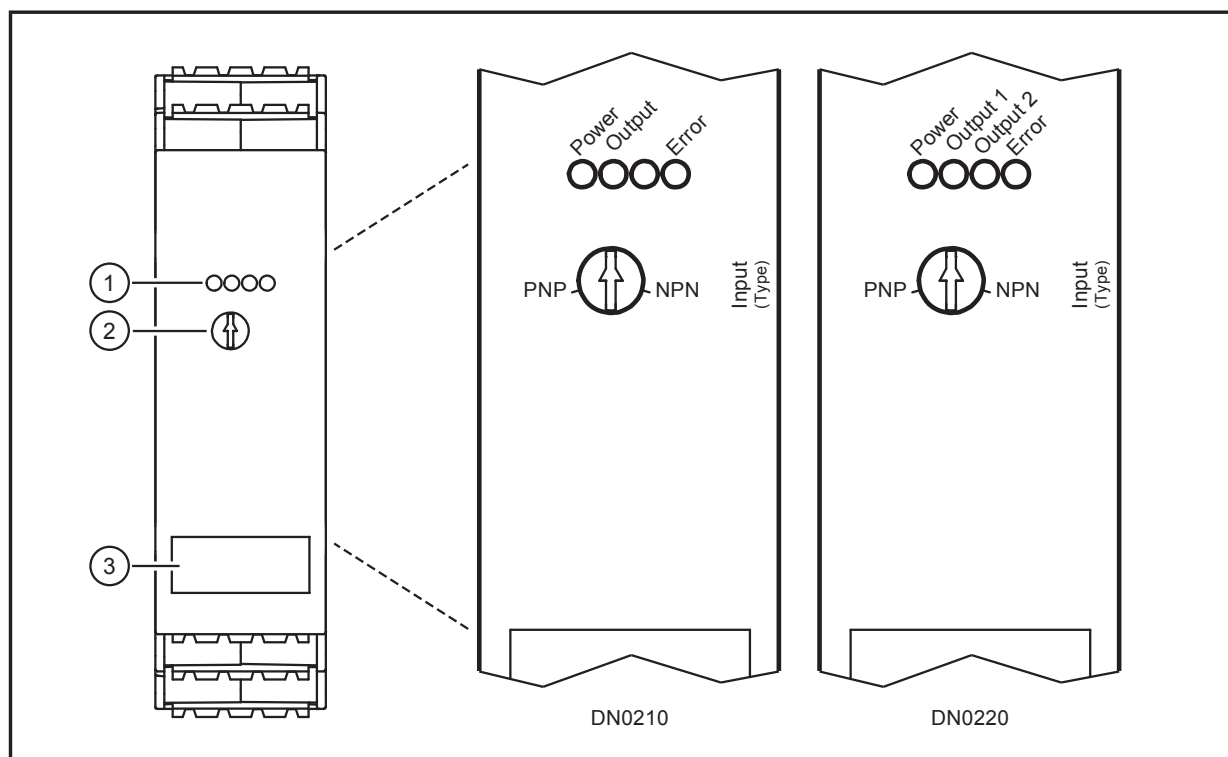

DN0210 (1-channel)

DN0220 (2-channel)

- 1: LEDs
- 2: Potentiometer
- 3: Panel for labelling

### 4.1 LEDs

LED	Colour	Status	Description
Power	Green	On	Voltage supply OK
Output 1	Yellow	On	Relay 1 energised
Output 2	Yellow	On	Relay 2 energised
Error	Red	Flashing	Sensor supply overload or short circuit

Error signals and diagnosis (→ 10 Troubleshooting)

### 4.2 Potentiometer

Potentiometer	Setting
Input (type)	PNP (positive switching) NPN (negative switching)

Setting applies to both inputs.



## 5 Installation

### 5.1 Installation of the device

- ▶ Install the device on a 35 mm DIN rail.

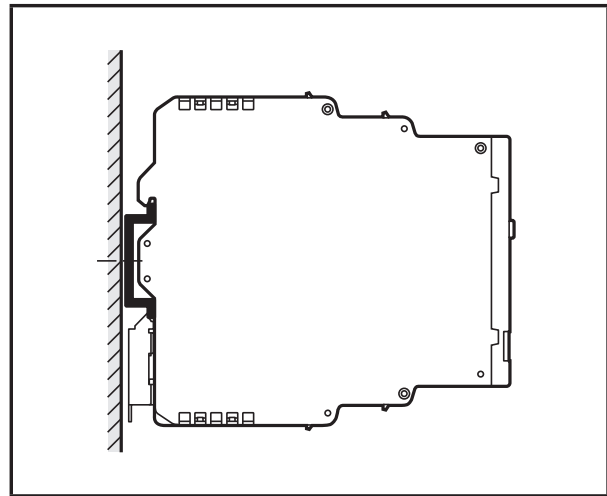
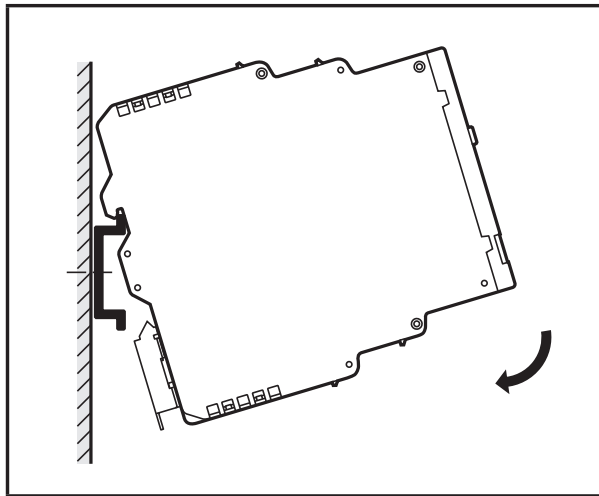

- ▶ Leave enough space between the unit and the top and bottom of the control cabinet to enable air circulation and to avoid excessive heating.
- ▶ Take into account the internal heating of all units when mounting several units side by side. The environmental conditions must be observed for every unit.

#### 5.1.1 Remove the device

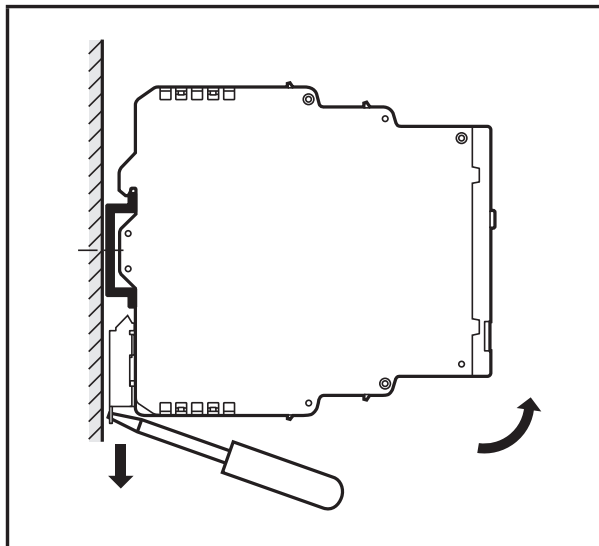

### 5.2 Mounting of the sensors

- ▶ Follow the manufacturer's installation instructions.

## 6 Electrical connection

### 6.1 Connection accessories

The unit is supplied including the connectors.

You can find more information about the available accessories at:  
[www.ifm.com](http://www.ifm.com) → Data sheet search → Article number → Accessories

### 6.2 Terminal connection

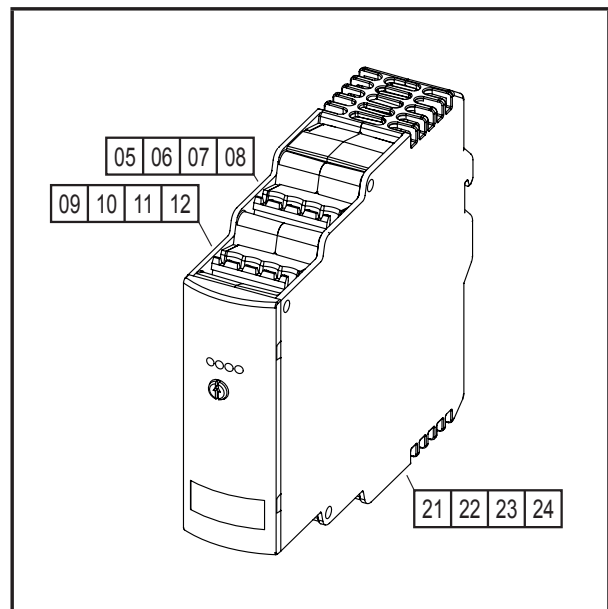
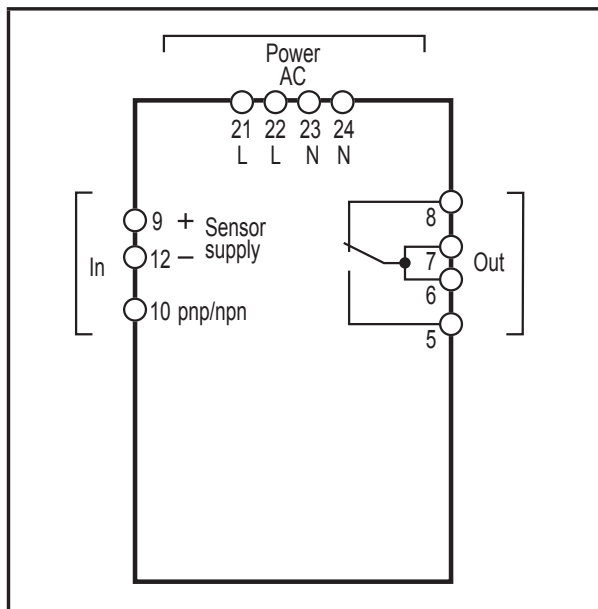

DN0210 (1-channel)

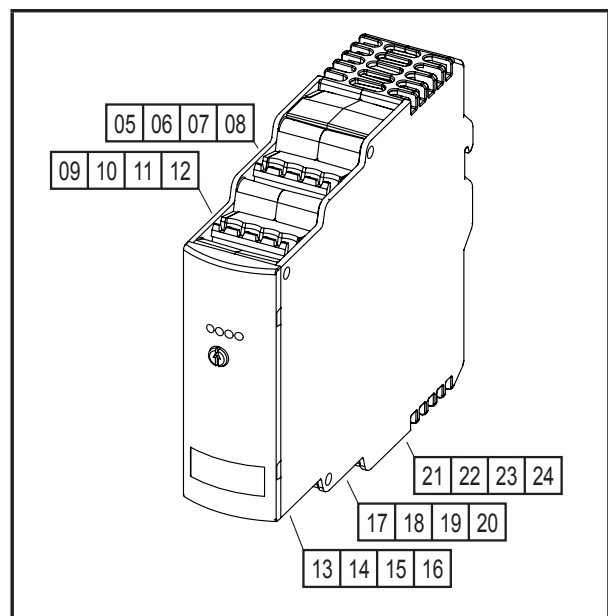
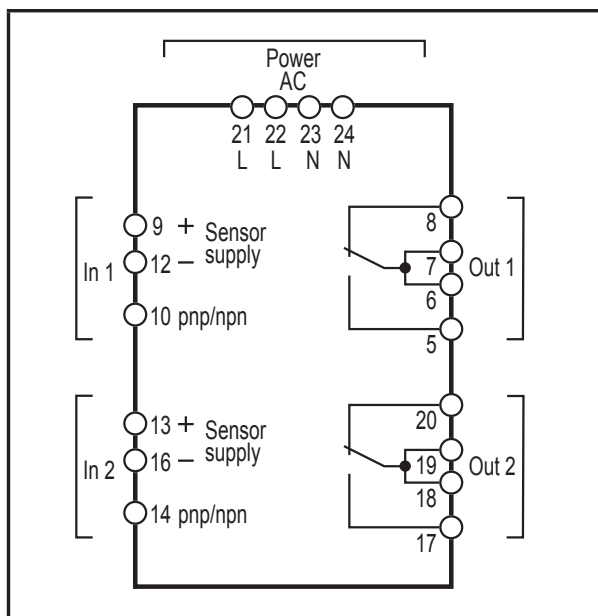

DN0220 (2-channel)

**⚠ WARNING**

Only the supplied or technically identical connectors may be used on the terminals blocks for the AC supply and the relay outputs (→ 9 Technical data). To ensure protection rating IP 20 for the housing and the terminals, fully tighten the screws of the unused connector contacts.

**⚠ WARNING**

Do not use unconnected terminals which are not shown in the drawing such as terminal 11 as support point terminal.

UK

### 6.3 Voltage supply (power)

- ▶ Voltage supply see type label.
- ▶ Connect the device to terminals 21/22 (L) and 23/24 (N).
- ▶ Lay all supply and signal cables separately. Use a screened cable if required in the application.

#### 6.3.1 AC supply

**⚠ WARNING**

The AC supply cable must be protected according to the cross-section used (max. 10 A).

The low voltage provided for the sensor supply meets the SELV criteria according to EN 61010, overvoltage category II, soiling degree 2.

## 6.4 Inputs

### 6.4.1 Connection of the sensors

Sensor type	Input 1	Input 2	Setting
3-wire DC PNP			PNP
3-wire DC NPN			NPN
2-wire DC quadronorm			PNP
2-wire AC/DC			PNP
Mechanical switch			PNP

BN = brown      BU = blue  
BK = black      WH = white

The connection of mechanical switch contacts is not recommended since they tend to bounce and produce faulty pulses.

## 6.5 Outputs

### 6.5.1 Relay outputs

- ▶ To prevent excessive wear and to comply with the EMC standards, interference suppression of the contacts is required for switching inductive loads.

#### **WARNING**

To switch an AC voltage via the relay outputs, the AC supply must use the same supply cable (phase) as the voltage supply of the unit.

If the relay outputs are used to switch very small currents (e.g. PLC input), considerable contact resistance can arise.

## 7 Settings

- ▶ Set the continuously adjustable potentiometer using a suitable screwdriver.
- ▶ Input type setting see table (→ 6.4.1 Connection of the sensors).

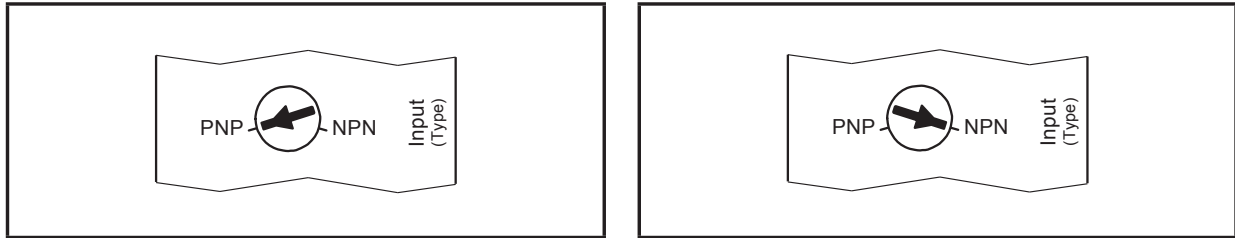

Settings

UK

### 7.1 Switching diagram

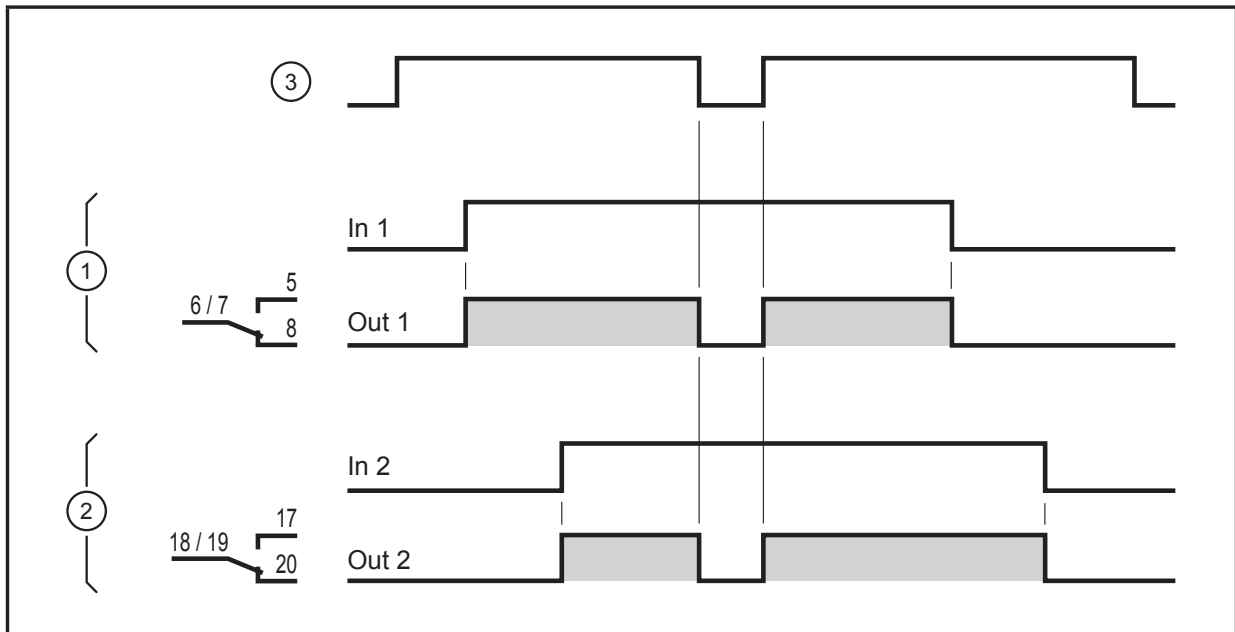

1: Channel 1

2: Channel 2

3: Voltage supply of the unit

▬ = relay energised, i.e. switched

## 8 Scale drawing

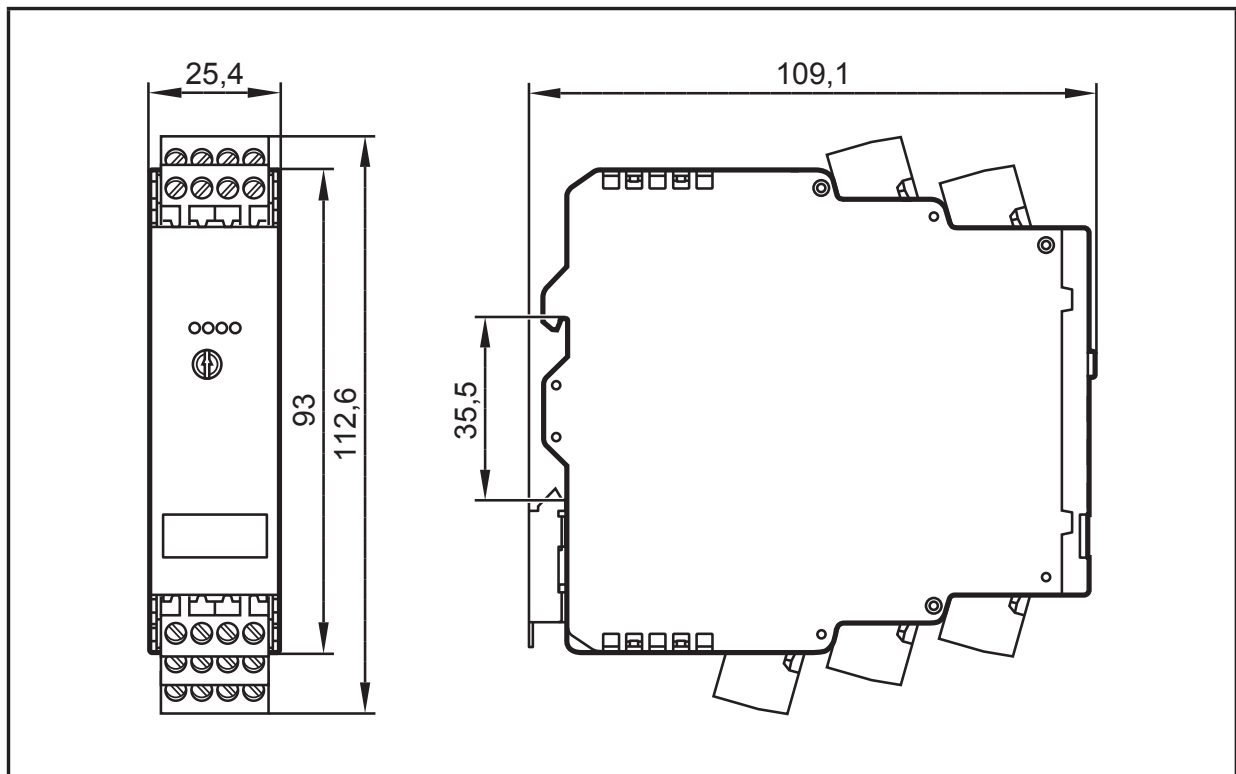

Figure shows DN0220 (2-channel) with connectors

## 9 Technical data

Order no.		DN0210	DN0220
Number of channels		1	2
Nominal voltage AC	[V]	110...240	
Nominal frequency	[Hz]	50...60	
Voltage tolerance	[%]	-20/+10	
Power consumption	[W]	≤ 11	
Auxiliary energy for sensors	[V]	24 DC SELV	
Voltage tolerance	[%]	±10	
Current per channel	[mA]	≤ 300	≤ 150
Sensor type (pulse input)		PNP/NPN (type 2 to IEC 61131-2)	
Input frequency	[Hz]	≤ 10 (duty cycle 50 % )	

Order no.		DN0210	DN0220
Relay contact rating	[A]	4 Resistive load (240 V AC or 24 V DC) Electrically isolated Reinforced insulation to EN 61010 Overvoltage category II, Degree of soiling 2 to 240 V AC nominal voltage	
Protection housing / terminals		IP 20 / IP 20	
Ambient temperature	[°C]	-20...60	
Storage temperature	[°C]	-25...70	
Max. perm. relative humidity	[%]	80 (31 °C) Linearly decreasing to 50 (40 °C) Non condensing	
Maximum operating altitude	[m]	3000 above sea level	
Connection			
Device		4-pole terminal blocks with 5.0 mm pitch	
Connector		4 poles with screw connection (supplied with the unit)	
Type		Phoenix Contact MSTBT 2,5/4-ST BK 0.2...2.5 mm <sup>2</sup> (AWG 30...12)	

UK

Data sheets are available at:

[www.ifm.com](http://www.ifm.com) → Data sheet search → Article number

### 9.1 Approvals/standards

EC declarations of conformity, approvals etc. can be downloaded at:

[www.ifm.com](http://www.ifm.com) → Data sheet search → Article number → More information

## 10 Troubleshooting

LED				Error	Troubleshooting
Power	Output 1	Output 2	Error		
●	--	--	⊗	Short circuit or overload at one or both sensor supply terminals.	Remove short circuit or overload.

Legend:

- off
- on
- ⊗ flashing
- any

## 11 Maintenance, repair, disposal

### 11.1 Maintenance

The unit is maintenance-free.

### 11.2 Cleaning the housing surface

- ▶ Disconnect the device.
- ▶ Clean the device from dirt using a soft, chemically untreated and dry cloth.



Micro-fibre cloths without chemical additives are recommended.

### 11.3 Repair

- ▶ The device must only be repaired by the manufacturer.  
Observe the safety instructions.

### 11.4 Disposal

- ▶ Dispose of the device in accordance with the national environmental regulations.





