



# PFA030 Owner's Manual



## Table of Contents

<b>1. Product Information</b>	<b>1</b>
1.1 Specifications & Performance .....	1
1.2 Temperature Limits.....	2
1.3 Dimensions .....	2
1.4 Bill of Materials.....	3
<b>2. Installation</b>	<b>4</b>
2.1 Precautions .....	4
2.2 Warnings .....	5
2.3 Advantages .....	5
2.4 Environment & System.....	5
2.5 Installation Instructions.....	6
<b>3. Control &amp; Monitoring</b>	<b>7</b>
3.1 Shift Logic for Fiber-optic Pumps .....	8
3.2 Fiber Optic Stroke Detection Installation .....	9
3.3 Calibrating D10 Amplifier for Stroke Detection .....	9
3.4 Conductivity Leak Detection Installation.....	10
3.5 Fiber Optic Leak Detection Installation .....	10
3.6 Calibrating D10 Amplifier for Leak Detection .....	11
<b>4. Ordering Instructions</b>	<b>12</b>
<b>5. Pump Service</b>	<b>13</b>
5.1 Rebuild Kits & Parts .....	13
5.2 Return Pump for Service.....	14
<b>6. Warranty &amp; Accessories</b>	<b>16</b>





Dear valued customer,

Thank you for purchasing a White Knight PFA030 pump.

Our dedicated team designs products to meet your exacting specifications with a demonstrated commitment to quality that goes beyond mere words and fancy slogans.

Our patented designs offer a variety of size and material options to meet stringent requirements of high-pressure chemical delivery systems, high-temperature re-circulation processes, chemical reclaim and bulk transport applications, slurry systems, and more. Our safe, reliable products offer superior performance, optimized efficiency, and simplified maintenance.

White Knight is able to provide the highest quality fluid handling products through controlled, consistent in-house engineering and manufacturing. Through continued significant investments in engineering and manufacturing, we lead the industry with new technologies and products.

White Knight has received numerous awards for innovation and manufacturing programs. We rigorously manage our quality assurance processes to ensure consistency and reliability. Our quality controls include strict cleanliness procedures and consistent manufacturing processes. For example, high-purity product assembly, testing, and packaging is performed in a Class 100 cleanroom.

Please peruse this manual before installing your White Knight product. It details installation requirements and setup instructions, and provides additional information and accessories for enhanced functionality.

Our team has gone to great lengths to ensure our products serve your needs and meet your requirements.

Further, we provide the highest quality products at the best value, and we back them up with excellent warranties and world class support.

Thank you for your confidence and trust in White Knight products.

Sincerely,

White Knight Fluid Handling





# 1. Product Information

## 1.1 Specifications & Performance

Model	PFA030	PFASD030
Max Flow Rate*	25.7 lpm (6.79 gpm)	29.6 lpm (7.82 gpm)
Displacement Per Cycle*	0.089 liters (0.024 gal)	0.089 liters (0.024 gal)
Cycles per min	336 max	294 max
Air Connection	1/4 in	1/4 in
Weight	2.4 kg (5.29 lb)	2.4 kg (5.29 lb)
Suction Lift*	3 m (10 ft)	Flooded suction
Sound	Pressure**	69.54 dB(a) at 100 psi 50 CPM 66.58 dB(a) at 100 psi max CPM
	Power**	58.44 dB(a) at 100 psi 50 CPM 65.52 dB(a) at 100 psi max CPM

Max Fluid Temperature	100°C (212°F)
Environmental Temperature	min: 0°C (32°F) max: 50°C (122°F)
Max Supply Air Pressure	7 Bar (100 psi)
Min Startup Air Pressure	1.4 bar (20 psi)
Fluid Path Materials	PTFE, PFA
Non-Fluid Path Materials	PTFE, PFA, PP

Stroke Detection	Fiber optic with or without D10 sensor
Leak Detection	Fiber optic with or without sensor, or conductivity
Electronic Control	CPC, CPT, or custom. Call for details.

\* May vary by configuration or system. Suction lift diminishes over time. Recommended installation level less than 3 ft above source. To calculate displacement, divide flow rate by CPM.

\*\* Sound measured in accordance with ISO9614-2:1997.

\*\*\* Dry-run capable PFASD030 pumps require flooded suction and may have reduced warranty. Contact support for details.

### PFA030 Performance

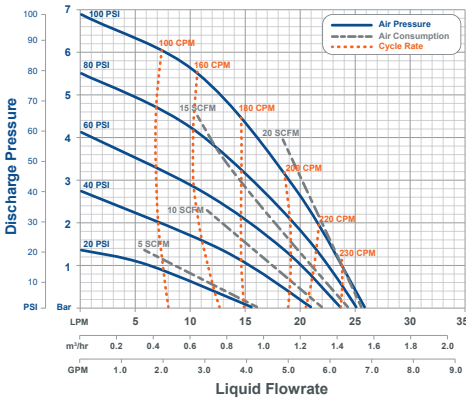

### PFASD030 Performance

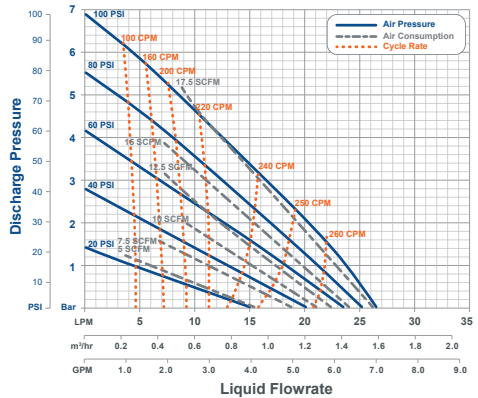

#### How to Read Charts

Draw a horizontal line at your discharge pressure and vertical line at desired flow rate. At line intersect, estimate required air pressure, resultant cycle rate and air consumption.

#### Example

At 2 Bar (30 psi) discharge pressure and 60 psi supply pressure, PFA030 pumps provide 15 lpm (4 gpm) flow rate. They would cycle at ~185 CPM, and exhaust 12 SCFM of air.

\*Graph is for reference only. Performance was measured utilizing 1/2 in (3/8 in ID) air line and 1-1/4 in (1-1/8 in ID) liquid lines with 1 ft flooded suction. Performance may vary in your system.





### 1.2 Temperature Limits

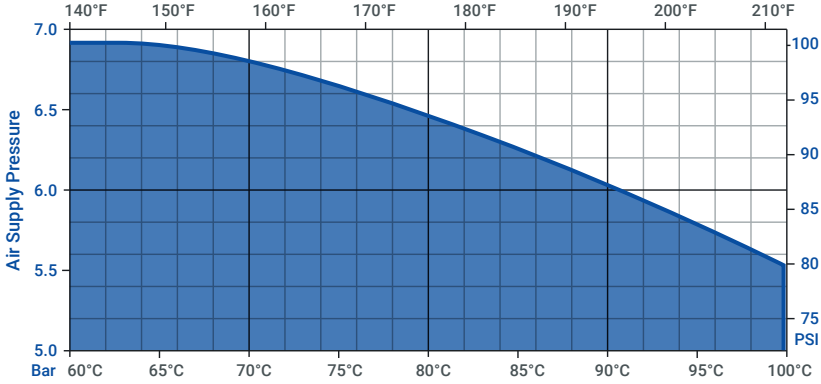

### 1.3 Dimensions

Dimensions in [mm] in

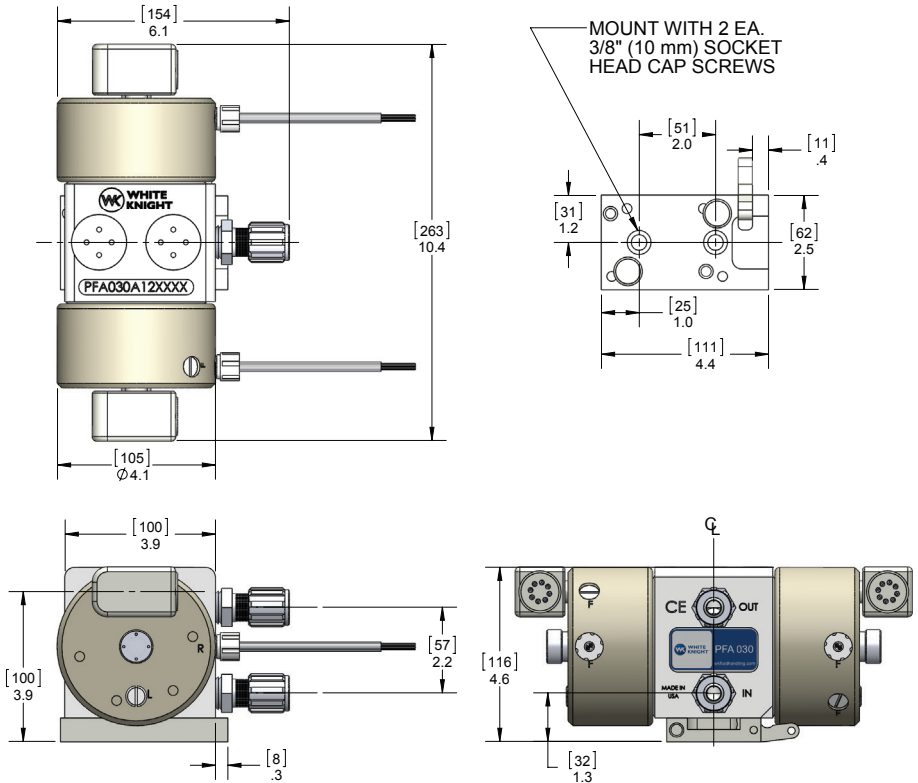



### 1.4 Bill of Materials

PFA030 BILL OF MATERIALS			
Item	Part	Description	Qty.
1	1125-TE-0017	Pump Body	1
2	2127-EP-0020	Head, Right	1
3	2127-EP-0021	Head, Left	1
4	14300-PF-0016	Bellows Assembly	2
5	5143-MP-0001	Seal, Shaft	2
6	5144-PF-0024	Shaft	1
7	4140-TE-0001	Top Check Plug	2
8	4142-MP-0004	Cage, Check	2
9	4135-MP-0006	Seat, Check	2
10	4100-MP-0004	Ball, Check, 1/2"	4
11	14200-NP-0006	Plate, Base Assembly	1
12	10040-TE-0003	Plug, NPT, 1/4"	2
13	10040-TE-0006	5/8" Plug Short	2
14	8100-PF-0002	Cap, End, Single Probe Dual Detect	2
15	3200-VI-0001	Diaphragm, Ø .782	2
16	6150-UH-0001	Seat, QEV Exhaust	2
17	10080-VI-016-75	O-ring, 016 X .070	2
18	6150-NP-0007	Cap, Muffler, QEV	2
19	6140-FP-0002	Baffle Porous Poly QEV	4
20	6140-PP-0004	Mesh, QEV 04 & 05	6
21	7200-PF-0003	Body, Flaretek®, 1/2"	2
22	7210-PF-0003	Nut, Flaretek®, 1/2"	1
23	14300-MP-0031	Bellows Assembly, Single Probe Dual Detect	2
24	6090-UH-0003	QEV Body, 05	2
25	14700-XX-0006	Stroke Detect Fiber Optic Assembly With Wire Cutter	2

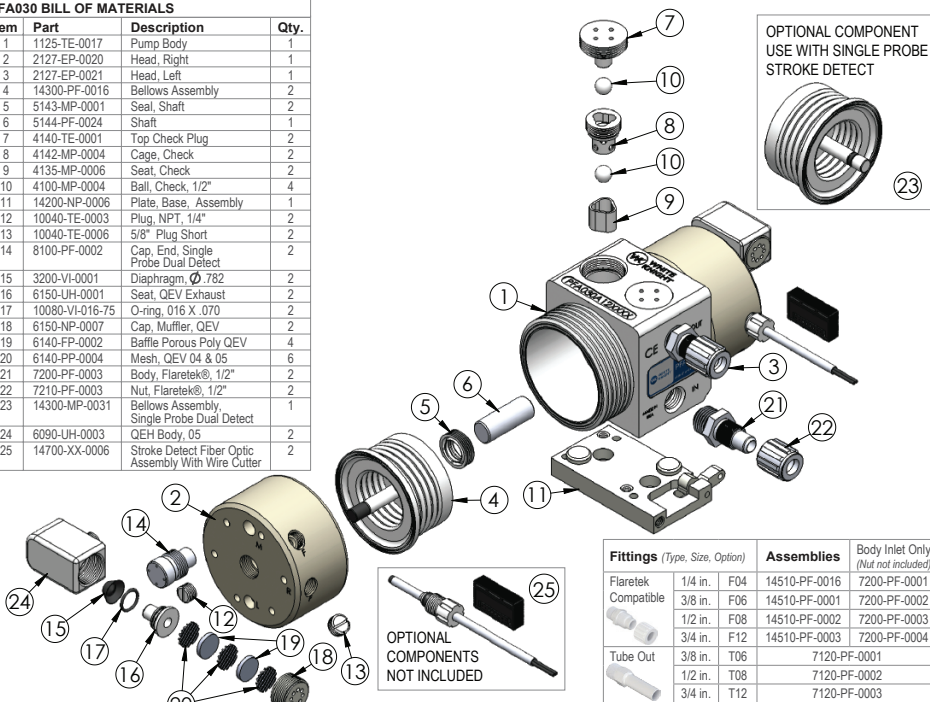

Leak Detect	
Part	Description
14600-XX-0009	LF0 15 ft fiber optic cable with no amplifier
14600-XX-0010	LF1 15 ft fiber optic cable with D10 amplifier
14600-XX-0011	LF2 25 ft fiber optic cable with no amplifier
14600-XX-0012	LF3 25 ft fiber optic cable with D10 amplifier
14600-XX-0031	LC0 15 ft conductivity cable
14600-XX-0040	LC1 25 ft conductivity cable

Stroke Detect	
Part	Description
14700-XX-0021	SFS0 15 ft fiber optic cable with no amplifier SFS0
14700-XX-0022	SFS1 15 ft fiber optic cable with D10 amplifier SFS1
14700-XX-0023	SFS2 25 ft fiber optic cable with no amplifier SFS2
14700-XX-0024	SFS3 25 ft fiber optic cable with D10 amplifier SFS3
14700-XX-0025	SFD0 15 ft fiber optic cable with no amplifier SFD0
14700-XX-0026	SFD1 15 ft fiber optic cable with D10 amplifier SFD1
14700-XX-0027	SFD2 25 ft fiber optic cable with no amplifier SFD2
14700-XX-0028	SFD3 25 ft fiber optic cable with D10 amplifier SFD3

Fittings (Type, Size, Option)	Assemblies	Body Inlet Only (Not included)
Flaretek Compatible	1/4 in. F04	14510-PF-0016 7200-PF-0001
	3/8 in. F06	14510-PF-0001 7200-PF-0002
	1/2 in. F08	14510-PF-0002 7200-PF-0003
Tube Out	3/4 in. F12	14510-PF-0003 7200-PF-0004
	3/8 in. T06	7120-PF-0001
Weldable	1/2 in. T08	7120-PF-0002
	3/4 in. T12	7120-PF-0003
	1/2 in. W08	7300-PF-0001
Pillar S-300	3/4 in. W12	7300-PF-0002
	1/4 in. P04	14530-PF-0025 7400-TE-0031
FNPT	3/8 in. P06	14530-PF-0012 7400-TE-0023
	1/2 in. P08	14530-PF-0001 7400-TE-0001
	3/4 in. P12	14530-PF-0002 7400-TE-0002
	1/4 in. N04	7100-TE-0001
Synchro-Flare	3/8 in. N06	7100-TE-0002
	1/2 in. N08	7100-TE-0003
	3/4 in. N12	7100-TE-0007
	3/8 in. S06	14520-TE-0009 7010-TE-0001
PrimeLock	1/2 in. S08	14520-TE-0001 7010-TE-0003
	3/4 in. S12	14520-TE-0002 7010-TE-0002
	1/4 in. L04	14570-PF-0013 7800-TE-0013
Plugged	3/8 in. L06	14570-PF-0014 7800-TE-0014
	1/2 in. L08	14570-PF-0001 7800-TE-0001
	3/4 in. L12	14570-PF-0002 7800-TE-0002
	B00	7130-TE-0001





## 2. Installation

### 2.1 Precautions

#### Handling

Do NOT lift pump by fiber optic cables, quick exhaust valves nor air tubing.

#### Installation Orientation

PFA030 pumps must be installed in an upright position. The check valves are actuated by gravity and/or flow, and they will not seat if the pump is not upright.

#### Timer Mode

PFA030 pumps require an end of stroke detection mechanism (pressure switch) to prevent over stroking in timer mode. Operating a PFA030 in timer mode without stroke detection will void the pump warranty.

#### Required Air Flow (Shuttle Valve)

PFA030 pumps require 1/4 in minimum orifice with unrestricted air flow.

#### Required Air Flow (Solenoid Valve)

PFA030 pumps require a 0.75 Cv solenoid. Using a reduced Cv will reduce flow rates. Using a valve with more than 20% greater Cv will change operating parameters, reduce pump life and void the warranty.

#### Under Supply of Air

PFA030 pumps operate erratically or stall when air supply is insufficient. Ensure use of air supply pressures higher than averaged air consumption lines in performance charts. Air supply lines and fittings must meet minimal inner diameter requirements shown in the installation instructions.

#### Air Supply Pressure

Operating PFA030 pumps ~35% below max air pressure may significantly extend pump life. PFA030 pumps require 20 psi minimum air pressure. Operation above 7 Bar (100 psi) may damage the pump and void the warranty.

#### Suction Lift

PFA030 pumps have an initial suction lift capacity of 3 ft. For best results minimize suction lift.

#### Liquid Inlet/Outlet Connections

PFA030 liquid ports are not NPT nor any other standard. Use of connectors other than those supplied by White Knight will damage the pump and void the warranty.

#### Liquid Line Restriction

PFA030 pumps may be controlled by closing liquid outlet lines. However, restricting liquid supply lines increases wear and should be avoided. Do NOT pump against a closed liquid inlet. It will damage the pump and void the warranty.

#### Running Dry

PFA030 pumps use the pumped liquid to lubricate their shafts. The pumps will cycle faster and wear more than normal when run dry, which may cause damage and loss of self-prime abilities. Standard models should not be run dry after start-up and are not warranted under dry run conditions. Dry-run capable PFASD030 models may run dry for short periods. Warranty of dry-run models is one-year. Extended warranties are available.

#### Pulse Dampener with Shuttle Valve

Air supply pressure to PFA030 pumps should be at least ten psi higher than the liquid line pressure when using a pulsation dampener. Failure to do so may cause erratic operation.

#### Cross Contamination

PFA030 pumps use porous material that may retain chemicals. Take precautions to avoid cross contamination.



## 2.2 Warnings

### Pressurized Material



Pumps in use contain pressurized materials. Eliminate liquid and air pressure via shut off valves before pump is serviced or removed from the system.

### High Temperature



Heat may transfer to exterior surfaces when pumps operate with high temperature fluids. Avoid direct contact with the pump when high temperature fluids are present.

### Hazardous Chemical



Use appropriate personal protective equipment when handling pump. Reference Material Safety Data Sheet (MSDS) for information specific to your chemicals.

### Loud Noise



Pump exhaust air contributes to work area noise levels. Only operate pumps with approved muffler media, and use ear protection in noisy conditions.

## 2.3 Advantages

### Head Pressure / Dead-Head

PFA030 pumps can be controlled by adjusting their liquid outlet pressures and can be installed with head pressures up to dead-head (e.g. equal liquid and air pressures) with no damage to the pump.

### Thermal Cycling

PFA030 pumps require no maintenance when operated within their performance range, even in thermal cycling applications.

## 2.4 Environment & System

### Oversized Inlet Line

Pumps operate optimally with liquid inlet lines larger than the liquid outlet lines. This reduces strain on the bellows and may reduce pulsation in the pump outlet.

### Clean Supply Air (CDA)

PFA030 pumps require use of Class 2 air for particles and moisture per ISO 8573-1. Use 10 micron filter; maintain -40°C dew point. A point-of-use filter is recommended during first six months of operation in new fabs/systems due to high risks of debris that can damage pumps and void warranty.

### Flammable Solvents

PFA030 pumps are not constructed from conductive materials. System that pump flammable solvents should be properly grounded to avoid ignition by static charge. A River's Edge test of isolative pumps with flammable liquids indicated that liquids must be grounded and other procedures should be followed. Copy of test available.

### Pumping Liquids Near Boiling Point

Minimizing suction lift reduces pulsation and the potential for boiling or outgassing of liquid in the inlet of the pump. Although reciprocating pumps can pull suction lift, pump performance and life increase when suction lift is minimized or eliminated.

### Abrasive Slurry

Pumping abrasive slurry may accelerate wear of components. PFA030 pumps are warranted when used with slurry. However, normal wear is not covered by warranty.

### Environmental Temperature

PFA030 pumps are rated for 0°C (32°F) - 50°C (122°F) environmental temperatures. Do not freeze fluid in pump. Operation below 0°C may accelerate wear. Normal wear is not covered by warranty.



D10 amplifier must be calibrated before attaching fiber optic probes to the pump.

### 2.5 Installation Instructions

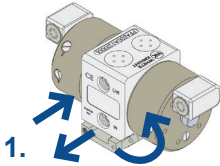

**1.** Set lever to up position. Slide base plate forward or pump body backward.

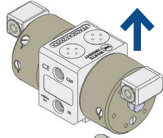

**2.** Lift pump off of base plate.

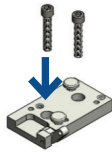

**3.** Screw base plate to surface with 3/8 in or 10 mm head cap socket screws into pre-drilled holes.

*Pull-back dismount is standard. See steps 3.1-3.3 for forward dismount.*

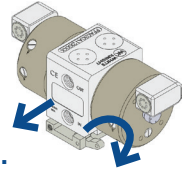

**4.** Set pump on base knobs; slide it forward. Set lever to down position.

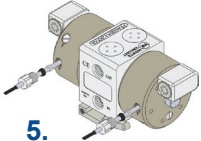

**5.** Insert fiber-optics fully into heads. Push in ferrule and gripper; hand-tighten nut.

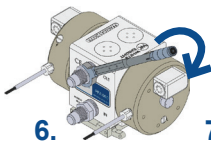

**6.** Attach fittings to pump. Tighten to 20 inch-lbs.

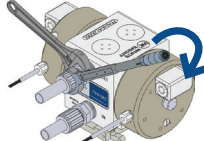

**7.** Attach tubes and fittings per manufacturer instructions. Use backer wrench to hold fittings in place at pump.

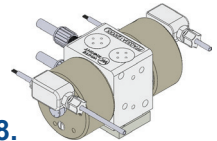

**8.** Set air line via 1/4 in FNPT ports on quick exhaust valves. Line must be 3/16 in minimum orifice.

#### Push-Forward Dismount Configuration Setup

Replace step 4 with steps 3.1-3.3 to re-configure the base plate to push-forward dismount.

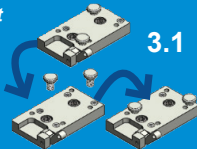

**3.1** Move knobs to opposite sides.

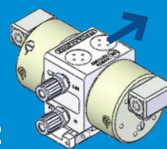

**3.2** Set pump on base knobs; slide it backward.

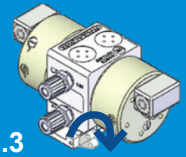

**3.3** Move lever down to locked position.

#### Install with Rigid Base Plate \*Requires push-forward dismount configuration (steps 3.1-3.3)

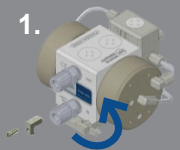

**1.** Remove L bracket. Set lever in neutral (up) position.

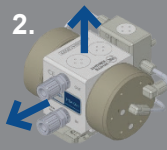

**2.** Slide pump forward; lift it off base plate.

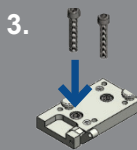

**3.** Fix base plate to work station. See step 4 above.

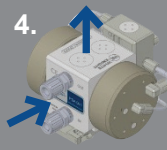

**4.** Return pump to base plate.



**5.** Move lock lever to down position. Reattach L bracket. Tighten to 12 in-lb.

#### Liquid Inlet/Outlet

Liquid ports are not NPT nor any other standard. Use of connectors other than those supplied by White Knight will damage the pump.







### 3. Control & Monitoring

#### Programmable Control

White Knight CPT-1 controllers monitor and adjust run mode, flow rate, leak detection and other pump operations.



#### D10 Amplifier Electrical Hookups & Dimensions

White Knight recommends Expert™ D10 amplifier for use with fiber optic stroke and leak detection assemblies.

##### Standard Models and Main Unit

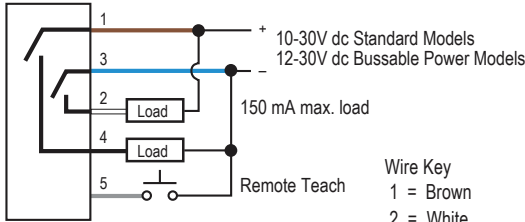

QD hookup is functionally identical (Pink wire not used)

- Wire Key
- 1 = Brown
  - 2 = White
  - 3 = Blue
  - 4 = Black
  - 5 = Gray

##### Sub-Units

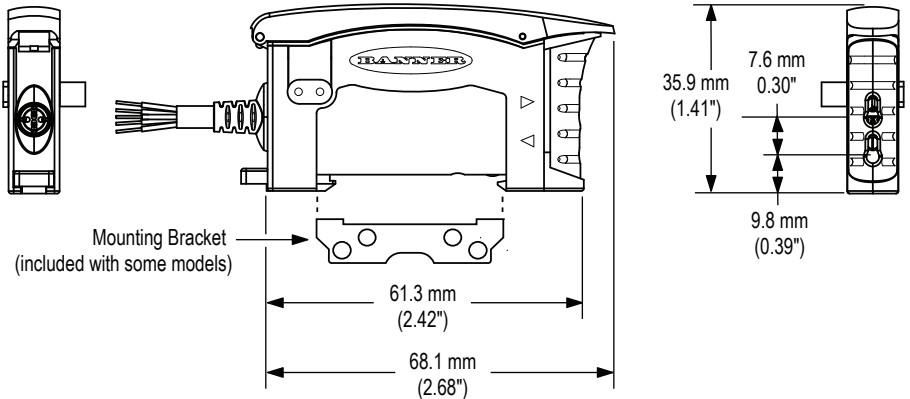
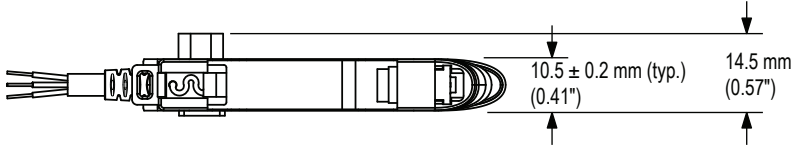
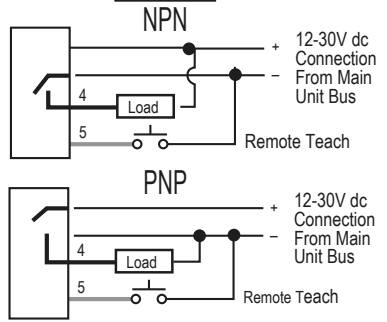



### 3.1 Shift Logic for Fiber-optic Pumps

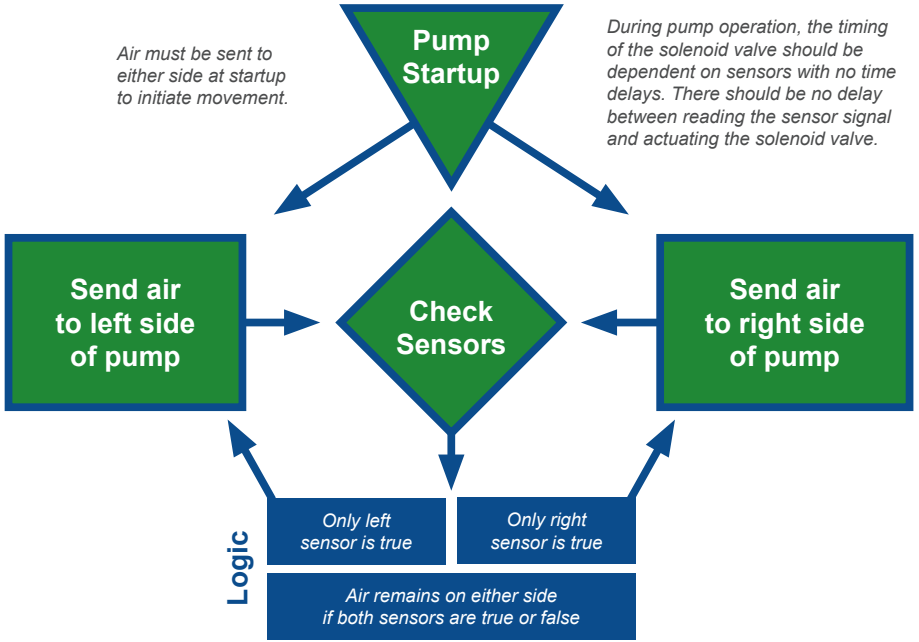



### 3.2 Fiber Optic Stroke Detection Installation

For standard end stroke, follow steps for both sides of the pump.

For single-probe dual-detect, follow steps for only the left side.

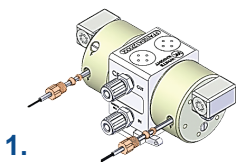

**1.** Insert fiber optic probes fully into heads. Push in ferrule and gripper; hand-tighten nut.

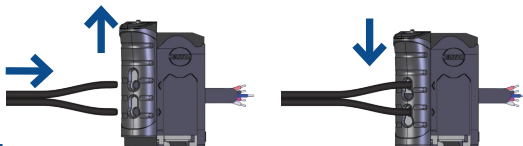

**2.** Open the top and slide the front face of the D10 up. Press the fiber optic ends into the holes on its front. Slide the face down to lock cables in place.

### 3.3 Calibrating D10 Amplifier for Stroke Detection

When calibrating the D10 Amplifier for stroke detection, the pump should be in the same operating conditions it will be in during normal operation (i.e. supply air pressure, back pressure, etc.). The Fiber Optic must be installed as per the instructions in section 3.1.

Calibration:			
	Push Button	Remote Line	Result
<b>Access Dynamic TEACH Mode</b>	Press and hold dynamic push button >2 seconds.	Hold Remote line low (to ground) >2 Seconds.	<ul style="list-style-type: none"> <li>Power LED: OFF</li> <li>Output LED: OFF</li> <li>Bar graph: LO &amp; DO Alternately Flashing</li> </ul>
<b>TEACH Sensing Conditions</b>	<ul style="list-style-type: none"> <li>Hold push button.</li> <li>Operate pump normally for 15 seconds.</li> </ul>	<ul style="list-style-type: none"> <li>Hold remote line low (to ground).</li> <li>Operate pump normally for 15 seconds.</li> </ul>	<ul style="list-style-type: none"> <li>Power LED: OFF</li> <li>Output LED: OFF</li> <li>Bar graph: LO &amp; DO Alternately Flashing</li> </ul>
<b>Return to Run Mode</b>	Release button	Release remote line/switch	Teach Accepted Power LED: ON Bar graph: One LED flashes to show relative contrast (successful setup requires minimum value of 4). Sensor returns to Run Mode with new settings.
			Teach Unaccepted Power LED: OFF Bar graph: #1, 3, 5, 7 alternately flash to show failure to sense. Sensor returns to Run mode without changing settings. Set up again if value shows <4.

Upon completion of a successful learning cycle, the D10 Amplifier will continuously learn and self-teach to maintain the same cycle rate count readings.





### 3.4 Conductivity Leak Detection Installation

Leaks are identified if conductive fluid contacts a sensor. Sensor provides a Sink (NPN) or Source (PNP) signal, depending on the wire setup. See the wiring diagrams below.

*Conductive leak detection does not qualify for use in explosion-proof environments. Conductive fluid required.*

See below for elbow out configuration.

-  Remove leak adapter from assembly.
-  Replace NPT plug in "L" port with probe. Hand Tighten. Attach cable to signal translator (e.g. PLC).

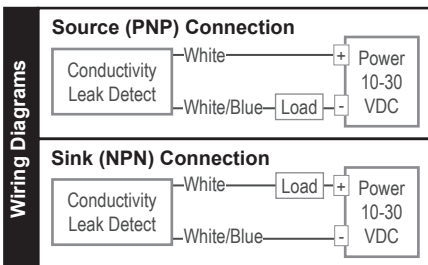

### 3.5 Fiber Optic Leak Detection Installation

*D10 amplifier must be calibrated before attaching fiber optic probes to the pump.*

*Fiber optic sensors can melt if used at >130°C (266°F), causing leak detect failure.*

See below for elbow out configuration.

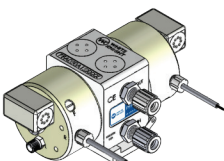
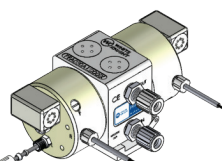
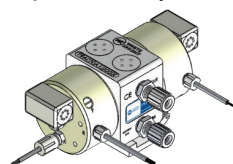
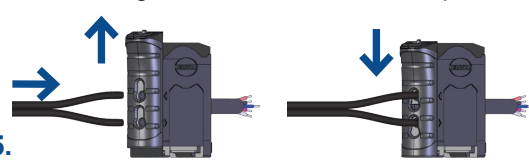
-  Remove leak adapter and leak detect probe from fiber optic assembly.
-  For straight out configuration replace NPT plug in "L" port with the probe. Hand-tighten.
-  Insert the fiber optic cable until it contacts the bottom of the probe.
-  Lower ferrule and gripper until snug against the probe. Hand tighten female gripper nut.
-  Open the top and slide the front face of the D10 up. Press the fiber optic ends into the holes on its front. Slide the face down to lock cables in place.

For elbow out configuration:

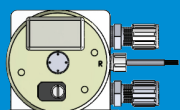
-  Replace NPT plug in "L" port with elbow adapter.

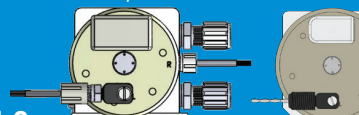
-  Attach fiber optic or conductivity leak detect probe per instructions above.





### 3.6 Calibrating D10 Amplifier for Leak Detection

#### Step 1: Power On D10 Amplifier & Set "Dark Operate" Mode:

	Push Button <i>0.04 s ≤ "Click" ≤ 0.8 s</i>	Remote Line <i>0.04 s ≤ T ≤ 0.8 s</i>	Result
<b>Access Setup Mode</b>	Press and hold both buttons > 2 seconds. 	Double-pulse remote line 	<ul style="list-style-type: none"> <li>Green Power LED turns OFF.</li> <li>Output LED remains active.</li> <li>Icons continue to display current setup.</li> <li>Bargraph turns OFF.</li> </ul>
<b>Select Settings</b>	Press either button until LEDs show desired settings. 	Pulse the remote line until LEDs show desired settings.  Note: Double-pulsing remote line causes setting to "back up" one step.	Sensor toggles through these setting combinations: LO - Normal Speed - No Delay (default) DO - Normal Speed - No Delay LO - High Speed - No Delay DO - High Speed - No Delay LO - Normal Speed - Delay DO - Normal Speed - Delay LO - High Speed - Delay DO - High Speed - Delay
<b>Return to Run Mode</b>	Press and hold both buttons > 2 seconds. 	Hold remote line low > 2 seconds. 	<ul style="list-style-type: none"> <li>Green Power LED turns ON.</li> <li>Sensor returns to Run mode with new settings.</li> </ul>

#### Step 2: Access "Single-Point Dark Set" Mode

	Push Button <i>0.04 s ≤ "Click" ≤ 0.8 s</i>	Remote Line <i>0.04 s ≤ T ≤ 0.8 s</i>	Result
<b>Access Set Mode</b>	Press and hold static button > 2 seconds. 	Single-pulse remote line 	<ul style="list-style-type: none"> <li>Power LED: OFF.</li> <li>Output LED: ON (push button) OFF (remote line)</li> <li>Static LEDs: LO &amp; DO alternately flashing</li> </ul>

#### Step 3: Set Sensing Condition

Set condition to "leak detection" sensing while probe tip is submerged in liquid. Then, remove the leak probe from liquid and reinserted into the "L" port. Amplifier will now signal when moisture is detected on the probe tip.

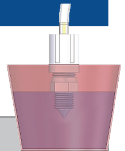

	Push Button <i>0.04 s ≤ "Click" ≤ 0.8 s</i>	Remote Line <i>0.04 s ≤ T ≤ 0.8 s</i>	Result
<b>Set Sensing Condition</b>	<ul style="list-style-type: none"> <li>Present sensing condition</li> <li>Five-click static button</li> </ul> 	Present sensing condition • Five-pulse remote line 	<ul style="list-style-type: none"> <li>Power LED: ON.</li> <li>Output LED: ON (push button) OFF (remote line)</li> <li>Bargraph: 4 indicators flash.</li> <li>Sensor returns to Run mode with new settings</li> </ul> <ul style="list-style-type: none"> <li>Power LED: ON.</li> <li>Output LED: ON (push button) OFF (remote line)</li> <li>Bargraph: #1, 3, 5, 7 flash for failure.</li> <li>Sensor returns to Set sensing condition.</li> </ul>





### 4. Ordering Instructions

Required (Default Model)

Additional Options (Blank if not needed)

<b>PFA030</b>	<b>-F08</b>	<b>-LF0</b>	<b>-SFD0</b>	<b>-TF08</b>	
1	2	3	4	5	6 Rev

Options 1-3 are required. Leave Additional Options blank if not desired. Only add Outlet if different than Inlet.

Default options are highlighted

1. Pump Model	
Standard	PFA030
Dry-Run	PFASD030

2. Check Ball Material	
PTFE Check balls	blank
PFA Check balls	F

3. Inlet Fitting		
<i>Front straight only</i>		
	1/4 in.	F04
	3/8 in.	F06
	1/2 in.	F08
	3/4 in.	F12
	3/8 in.	T06
	1/2 in.	T08
	3/4 in.	T12
	1/2 in.	W08
	3/4 in.	W12
	1/4 in.	P04
	3/8 in.	P06
	1/2 in.	P08
	3/4 in.	P12
	1/4 in.	N04
	3/8 in.	N06
	1/2 in.	N08
	3/4 in.	N12
	3/8 in.	S06
	1/2 in.	S08
	3/4 in.	S12
	1/4 in.	L04
	3/8 in.	L06
	1/2 in.	L08
	3/4 in.	L12

4. Leak Detection	
No leak detection	blank
15 ft fiber optic cable with no amplifier	LF0
15 ft fiber optic cable with D10 amplifier	LF1
25 ft fiber optic cable with no amplifier	LF2
25 ft fiber optic cable with D10 amplifier	LF3
15 ft conductivity cable	LC0
25 ft conductivity cable	LC1

5. Stroke Detection	
No stroke detection	blank
DUAL PROBE OPTIONS	
15 ft fiber optic cable with no amplifier	SFD0
15 ft fiber optic cable with D10 amplifier	SFD1
25 ft fiber optic cable with no amplifier	SFD2
25 ft fiber optic cable with D10 amplifier	SFD3
SINGLE PROBE, DUAL DETECT OPTIONS	
Single probe, dual detect, no fibers	SFS
15 ft fiber optic cable with no amplifier	SFS0
15 ft fiber optic cable with D10 amplifier	SFS1
25 ft fiber optic cable with no amplifier	SFS2
25 ft fiber optic cable with D10 amplifier	SFS3

\* Fiber optic cables ordered separately. Fiber optics are required for operation. Standard configuration includes dual probe WITHOUT fibers. See stroke detection options to order fiber optic cables or single probe option.



Timer mode operation requires end-of-stroke detection. Use of timer mode without stroke detection voids the warranty.

Operating the pump without the included quick exhaust valves (QEVs) voids pump warranty. Customers may use their own QEVs with the optional NPT adapter.

6. Outlet Fitting			
<i>Straight only.</i>		Front	Top
<i>Select Top or Front.</i>			
<i>Same as Inlet</i>		blank	n/a
	1/4 in.	FF04	TF04
	3/8 in.	FF06	TF06
	1/2 in.	FF08	TF08
	3/4 in.	FF12	TF12
	3/8 in.	FT06	TT06
	1/2 in.	FT08	TT08
	3/4 in.	FT12	TT12
	1/2 in.	FW08	TW08
	3/4 in.	FW12	TW12
	1/4 in.	FP04	TP04
	3/8 in.	FP06	TP06
	1/2 in.	FP08	TP08
	3/4 in.	FP12	TP12
	1/4 in.	FN04	TN04
	3/8 in.	FN06	TN06
	1/2 in.	FN08	TN08
	3/4 in.	FN12	TN12
	3/8 in.	FS06	TS06
	1/2 in.	FS08	TS08
	3/4 in.	FS12	TS12
	1/4 in.	FL04	TL04
	3/8 in.	FL06	TL06
	1/2 in.	FL08	TL08
	3/4 in.	FL12	TL12

Revision	
No revision	blank
<i>Contact support for revision level or copy exact code activation details. Configured part numbers are not Copy Exact Part Numbers. support@wkfluidhandling.com</i>	





### 5. Pump Service

Pumps fully rebuilt by White Knight, certified rebuilders, or technicians certified by White Knight receive full warranty renewal. Details below.

#### White Knight Rebuilds

Request factory rebuilds by web form at: <https://wkfluidhandling.com/support/rma/>. An RMA# will be provided after processing.

*\*Customers must follow decontamination instructions in Section 4.4 when returning a pump to White Knight.*

#### Certified Rebuilders

White Knight's global network of certified rebuilders expedite rebuild turn-around time and minimize shipping costs. Find certified rebuilders at: <https://wkfluidhandling.com/rebuilders/>

#### Rebuild Pump as Certified Technician

White Knight offers trainings to certify technicians to rebuild pumps. Technicians who pass the training are issued a two-year certification. During the two years, parts in pumps rebuilt by the technician receive a full warranty. See: <https://wkfluidhandling.com/virtual-rebuilds/>

### 5.1 Rebuild Kits & Parts

Rebuild kit for PFA030 is RBPFA030-1. Rebuild kit for PFASD030 is RBPFA030-1 (labor not included). To request rebuilds by White Knight, use RBPFA030-5 or RBPFA030-5, respectively (labor included).

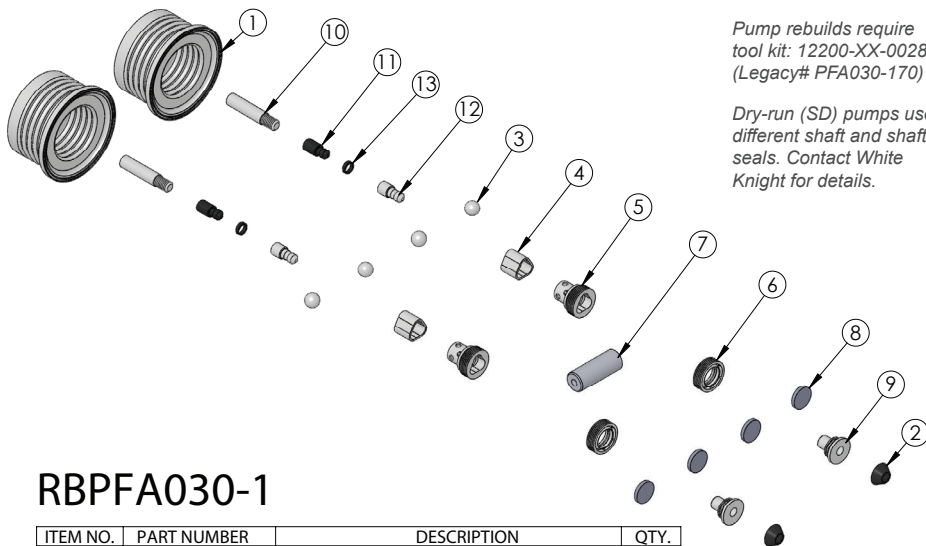

Pump rebuilds require tool kit: 12200-XX-0028 (Legacy# PFA030-170)

Dry-run (SD) pumps use different shaft and shaft seals. Contact White Knight for details.

## RBPFA030-1

ITEM NO.	PART NUMBER	DESCRIPTION	QTY.
1	3130-MP-0025	BELLOWS, A & H, 30L	2
2	3200-VI-0001	DIAPHRAGM, $\phi$ .782	2
3	4100-MP-0004	CHECK BALL 1/2"	4
4	4135-MP-0006	CHECK SEAT BOTTOM HI-FLOW 25L & 30L	2
5	4142-MP-0004	CHECK CAGE TOP HI-FLOW 25L & 30L	2
6	5143-MP-0001	SEAL, SHAFT, 30L	2
7	5144-PF-0024	SHAFT, SOLID, PFA, 30L	1
8	6140-FP-0002	BAFFLE, .800"	4
9	6150-UH-0001	SEAT, OEV EXHAUST, 30L & 60L	2
10	8140-TE-0004	STEM, SD TARGET, 30L	2
11	8150-BP-0001	EXTENSION, TARGET, UNIVERSAL	2
12	8150-TE-0005	EXTENSION, TARGET, .145	2
13	8160-BP-0005	BLANK, TARGET, .145	2





## 5.2 Return Pump for Service

Follow decontamination instructions when returning a pump for service.

**DO NOT REMOVE PAGE FROM MANUAL.**

Copy page from manual or download at <https://wkfluidhandling.com/support/rma/>.

# Decontamination Instructions

**PRINT COMPLETED DECONTAMINATION CERTIFICATION. IT MUST BE INCLUDED IN YOUR RMA SHIPMENT.**

White Knight products are designed for use with caustic and otherwise dangerous liquids. Handle every product as if it contains dangerous chemicals whether or not it actually does.

- Only those with adequate safety training should attempt to handle used pumps.
- Wear adequate safety gear appropriate for chemicals that have been in the pump.
- Review relevant Material Safety Data Sheets (MSDS) before handling the pump.
- Review emergency numbers for use in event of an accident.
- Prepare Ph papers, showers, antidotes, clean-up equipment, neutralizers, and other safety devices used to detect, neutralize or minimize effects of chemicals described in appropriate MSDS documents.

## Rinse with DI Water

Circulate DI water through pump for twenty minutes before disassembly and/or double bagging for shipment. If pump is nonfunctional, force DI water from inlet through outlet for 40 minutes before shipment preparations.

## Remove Pump from Station:

1. Disconnect liquid tubing connectors from front of pump (opposite shuttle valve).
2. Plug NPT fittings with PTFE plug, Flare fittings with flare nose cover and cap, or other plug or cap as recommended by connector supplier.
3. Disconnect air supply tubing from face of shuttle valve.
4. Loosen mount screw from base plate. (Note: do not remove screw from base plate).
5. Remove base plate using proper tool for the fastening devices (e.g. Allen wrench or screw driver). Note: Base plate may stay if needed for replacement pump to be used.
6. Return all removed parts to the pump.

## Return Pump to White Knight:

1. Rinse pump with DI water as described above after removing it from its station.
2. Drain remaining DI water from the pump inlet and outlet liquid tubing connectors.
3. Plug liquid outlets as described in the Remove Pump from Station section above.
4. Dry the pump, double bag it, and seal it in thick polyethylene bags.
5. Return the pump to its original packaging.
6. Include MSDS for the chemical that the pump was handling in the box with the pump.
7. Obtain RMA number from White Knight and write it on the outside of the box.
8. Ship to White Knight following all rules, regulations and laws regarding shipment of dangerous materials. Ship freight pre-paid. No collect shipments will be accepted. Unauthorized use of White Knight shipping accounts will result in the adding of freight to the bill in addition to a service charge.

## Include All Pump Components:

Pumps returned to White Knight for evaluation, service or repair must be complete with all components, including but not limited to base plate, mount screws, tubing connectors, tubing connector caps, flare noses, shuttle valves, mufflers, and tubing. Missing parts will be added to the pump and charged to the customer.







**DO NOT REMOVE PAGE FROM MANUAL.**

Copy page from manual or download at <https://wkfluidhandling.com/support/rma/>.

## Decontamination Certification

**COMPLETE AND PRINT THIS FORM. IT MUST BE INCLUDED IN YOUR RMA SHIPMENT.**

I, the undersigned employee of \_\_\_\_\_, certify that all decontamination and safety procedures described in Decontamination Instructions section have been followed for return of product below.

**RMA#:** \_\_\_\_\_

*(We cannot process returns without an RMA number.)*

**Serial#:** \_\_\_\_\_

*(We cannot process returns without a product serial number.)*

### **Metal Exposure:**

*(Check all that apply. Write in other metals if necessary.)*

Product was used in a Metal Process.  Yes  No

Product was used in a Copper Metal Process.  Yes  No

Product was used with:

- Aluminum  Cobalt  Gold  Lead  Nickel  Platinum  Silver  Tin  Titanium
- Tungsten  Zinc  Other: \_\_\_\_\_

### **Chemical Exposure:**

*(Check all that apply. Write in other chemicals if necessary.)*

Product was **NOT** used in chemicals (DI Water only).

Product was used in chemicals.

- Ammonia  Ammonium Hydroxide  Hydrochloric Acid  Hydrofluoric Acid  Hydrogen Peroxide  IPA
- Nitric Acid  Phosphoric Acid  Sulfuric Acid  Other: \_\_\_\_\_

### **Shipping Information:**

Please indicate metal processes to which the product has been exposed by clearly and conspicuously labeling the outside of the return package with the metal.

**Products exposed to Metal Processes must be sent to the following address:**

White Knight Fluid Handling  
187 East 670 South, Suite B  
Kamas, UT 84036

**Products NOT exposed to Metal Processes must be sent to the following address:**

White Knight Fluid Handling  
187 East 670 South, Suite C  
Kamas, UT 84036

Print Name: \_\_\_\_\_

Signature: \_\_\_\_\_

Date: \_\_\_\_\_





## 6. Warranty

White Knight follows strict manufacturing, assembly and testing procedures to ensure consistency and reliability.

White Knight warrants PFA030 pumps and components are free from defects in materials and workmanship for two years from our shipment date or your installation date if provided within 90 days of shipment from our facility.

Failures due to normal wear, misuse, abuse or unauthorized disassembly nullify this warranty.

White Knight does not guarantee the suitability of products for specific applications. White Knight is not liable for any damage or expense resulting from use or misuse of its products in any application. Responsibility is limited solely to repair or replacement of defective products or components.

Prior written, faxed or emailed approval must be obtained from White Knight before returning any product or component for warranty consideration. All determinations regarding cause of failure are made by White Knight, and all decisions regarding warranty fulfillment or nullification are made by White Knight.

THE FOREGOING WARRANTY IS EXCLUSIVE AND IN LIEU OF ALL OTHER WARRANTIES EXPRESSED OR IMPLIED, INCLUDING ANY GUARANTEE OF SUITABILITY FOR ANY PURPOSE. NO VARIATIONS OF THIS WARRANTY SHALL BE HONORED NOR CONSIDERED LEGALLY BINDING, EXCEPT WRITTEN AGREEMENTS SIGNED BY THE CEO OF WHITE KNIGHT FLUID HANDLING.

## Accessories

See ordering instructions or contact us for details.

### Stroke Detection

- Fiber Optic stroke detection with or without sensor
- Solid state pressure switch
- Solid state dual pressure switch

### Leak Detection

- Fiber Optic leak detection with or without sensor
- Conductivity leak detection

### CPT-1

- Control/monitor run mode and flow rate.

### Catcher™ Pre-Filters

- In-line and pump-mounted options
- Large through holes to avoid loading
- Filter may be removed without removing the Catcher™ from the pump or the line.
- Pumps damaged by passing solids that use a Catcher™ are repaired as in warranty.

### Filter Housing

- 100% non-metallic
- Allows for filter changing without disconnecting the inlet/outlet lines
- Rated for temperatures up to 210°C
- Install with industry standard connections
- Designed to allow for thermal cycling
- Upright and inverted installation options

### Quick Exhaust Valves

- Allows for immediate escape of exhaust air reducing pulsation and exposure of solenoid valve to corrosive fumes
- In-line and pump-mounted options
- UHMW-PE design
- Comes standard with a one-year warranty

### Pulse Dampeners

- Uses same CDA as supplied to pump
- In-line and pump-mounted options
- Sizes available for all PFA Series pumps
- Self-adjusting, Auto-Level Valve is regulated by liquid line pressure



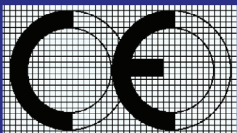

# Barclay-Phelps

CE MARKING SPECIALISTS  
Hoi Yuen Road, Kwun Tong, Kowloon, Hong Kong

## CERTIFICATE & DECLARATION OF CONFORMITY FOR CE MARKING

**Company contact details:**  
White Knight Fluid Handling Inc.  
187 E. 670 S., Kamas, Utah, 84036, USA

**White Knight Fluid Handling Inc. declares that their:**

    Bellows Pump Line

PSA030, PSA060, PSA140, PSH030, PSH060, PSH140, PSU030, PSU060, PSU140, PSA015, PSR050, PSR025, PFA030, PFA060, PFA140, PFH030, PFH060, PFH140, PFU030, PFU060, PFU140, PXA030, PXA060, PXA140, PXH030, PXH060, PXH140, PXU030, PXU060, PXU140, PFA015, LHA015, LHA030, LHA070

    Diaphragm Pump Line (Non Conductive)

PSD04TE, PSD06TE, PSD08TE, PSD16TE, PSD24TE, PSD04UH, PSD06UH, PSD08UH, PSD16UH, PSD24UH, PSB100

    Diaphragm Pump Line (Conductive)

PSD04TC, PSD06TC, PSD08TC, PSD16TC, PSD24TC, PSD04UC, PSD06UC, PSD08UC, PSD16UC, PSD24UC

    Legacy Pump Line

PLS30, PLS60, PLS120, PLX30, PLX60, PLX120, PX30, PX60, PX120, PLF30, PLF60, PLF120

    Metering Pumps

PPM100, PEM100, PEM050

    Plastic Pumps

PHC40-2, PPMC300, PPMA

TPA07 Pressure Transducer

**are classified within the following EU Directives as applicable:**

    Machinery Directive 2006/42/EC

    Low Voltage Directive 2014/35/EU

    Electromagnetic Compatibility Directive 2014/30/EU

    RoHS 2 Directive 2011/65/EU

**and further conform with the following EU Harmonized Standards as applicable:**

EN 809:1998+A1:2009    EN 60204-1:2006 + A1:2009    EN 61000-6-2:2005    EN 61000-6-4:2007+A1:2011

**Dated:** 16 January 2017

**Position of signatory:** Product Manager    **Name of Signatory:** Cory Ammon Simmons

**Signed below:** on behalf of White Knight Fluid Handling Inc.





**WHITE  
KNIGHT®**

.....*engineer approved™*

**White Knight Support**

187 E. 670 S.  
Kamas, UT 84036

Phone: 435.783.6040  
Toll Free: 888.796.2476  
Fax: 435.783.6128

[support@wkfluidhandling.com](mailto:support@wkfluidhandling.com)  
<https://wkfluidhandling.com/support/>



Part No. 18200-LM-0005



Copyright © 2023 White Knight Fluid Handling | A Graco company  
P: 435.783.6040 | [support@wkfluidhandling.com](mailto:support@wkfluidhandling.com) | <https://wkfluidhandling.com>

Version 2.1.9 | 5 Dec 2023  
Subject to change without notice