



# PFH060 Owner's Manual



## Table of Contents

<b>1. Product Information</b>	<b>1</b>
1.1 Specifications & Performance .....	1
1.2 Temperature Limits.....	2
1.3 Dimensions .....	2
1.4 Bill of Materials.....	3
<b>2. Installation</b>	<b>4</b>
2.1 Precautions .....	4
2.2 Warnings .....	5
2.3 Advantages .....	5
2.4 Environment & System.....	5
2.5 Installation Instructions.....	6
<b>3. Control &amp; Monitoring</b>	<b>7</b>
3.1 Shift Logic for Fiber-optic Pumps .....	8
3.2 Fiber Optic Stroke Detection Installation.....	9
3.3 Calibrating D10 Amplifier for Stroke Detection .....	9
3.4 Conductivity Leak Detection Installation.....	10
3.5 Fiber Optic Leak Detection Installation .....	10
3.6 Calibrating D10 Amplifier for Leak Detection .....	11
<b>4. Pump Service</b>	<b>12</b>
4.1 Ordering Instructions .....	12
4.2 Rebuild Information .....	13
4.3 Rebuild Kits & Parts .....	13
4.4 Return Pump for Service.....	14
<b>5. Warranty &amp; Accessories</b>	<b>16</b>





Dear valued customer,

Thank you for purchasing a White Knight PFH060 pump.

Our dedicated team designs products to meet your exacting specifications with the highest commitment to quality.

White Knight provides the highest quality fluid handling products through controlled, consistent in-house engineering and manufacturing. Our safe, reliable products offer superior performance, optimized efficiency, and simplified maintenance. We continue to lead the industry with new technologies and products.

Our patented designs offer a variety of size and material options to meet stringent requirements of high-pressure chemical delivery systems; high-temperature re-circulation processes; chemical reclaim and bulk transport applications; as well as slurry systems.

White Knight has received many prestigious awards for innovation and manufacturing programs. We rigorously manage our quality assurance processes to ensure consistency and reliability. Our quality controls include strict cleanliness procedures and consistent manufacturing processes. For example, product assembly and testing is done in a temperature and humidity-controlled cleanroom.

Please peruse this manual before installing your White Knight product. It details installation requirements and setup instructions, and provides additional information and accessories to enhance the product's functionality.

Our team has gone to great lengths to ensure our products serve your needs and meet your requirements.

Further, we provide the highest quality products at the best value, and we back them up with excellent warranties and world class support.

Sincerely,

Steve Smith, CEO  
White Knight Fluid Handling





### 1. Product Information

#### 1.1 Specifications & Performance

Model	PFH060	PFHSD060
Max Flow Rate*	63.9 lpm (16.88 gpm)	64.5 lpm (17.04 gpm)
Displacement Per Cycle*	0.216 liters (0.057 gal)	0.216 liters (0.057 gal)
Cycles per min	318 max	279 max
Air Connection	1/4 in	1/4 in
Weight	5.9 kg (12.96 lb)	5.9 kg (12.96 lb)
Suction Lift*	1 m (3 ft)	Flooded suction
Sound	Pressure**	82.74 dB(a) at 80 psi 50 CPM 82.61 dB(a) at 80 psi max CPM
	Power**	71.92 dB(a) at 80 psi 50 CPM 73.84 dB(a) at 80 psi max CPM

Max Fluid Temperature	145°C (293°F)
Environmental Temperature	min: 0°C (32°F) max: 50°C (122°F)
Max Supply Air Pressure	5.5 Bar (80 psi)
Min Startup Air Pressure	1.4 bar (20 psi)
Fluid Path Materials	PTFE, PFA
Non-Fluid Path Materials	PTFE, PFA

Stroke Detection	Fiber optic with or without D10 sensor
Leak Detection	Fiber optic with or without sensor, or conductivity
Electronic Control	CPC, CPT, or custom. Call for details.

\* May vary by configuration or system. Suction lift diminishes over time. Recommended installation level less than 3 ft above source. To calculate displacement, divide flow rate by CPM.

\*\* Sound measured in accordance with ISO9614-2:1997.

\*\*\* Dry-run capable PFHSD060 pumps require flooded suction and may have reduced warranty. Contact support for details.

#### PFH060 Performance

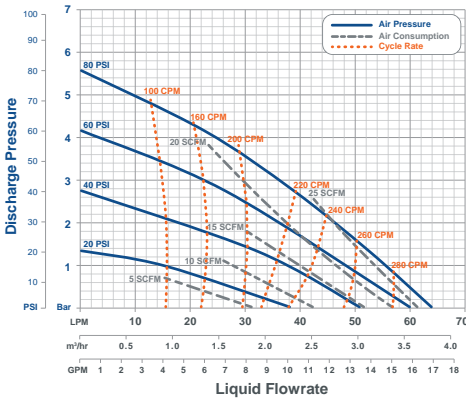

#### PFHSD060 Performance

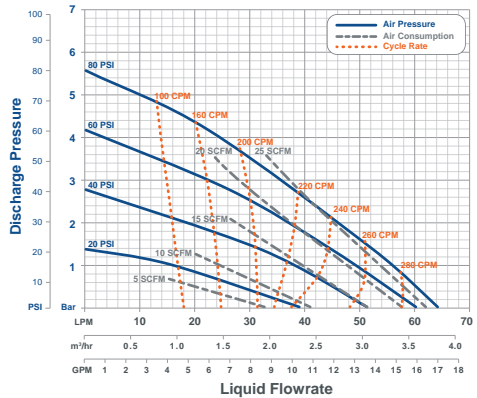

#### How to Read Charts

Draw a horizontal line at your discharge pressure and vertical line at desired flow rate. At line intersect, estimate required air pressure, resultant cycle rate and air consumption.

#### Example

At 2 Bar (30 psi) discharge pressure and 60 psi supply pressure, PFH060 pumps provide 36 lpm (9.8 gpm) flow rates. They would cycle at ~215 CPM and exhaust 19 SCFM of air.

\*Graph is for reference only. Performance was measured utilizing 1/2 in (3/8 in ID) air line and 1-1/4 in (1-1/8 in ID) liquid lines with 1 ft flooded suction. Performance may vary in your system.





### 1.2 Temperature Limits

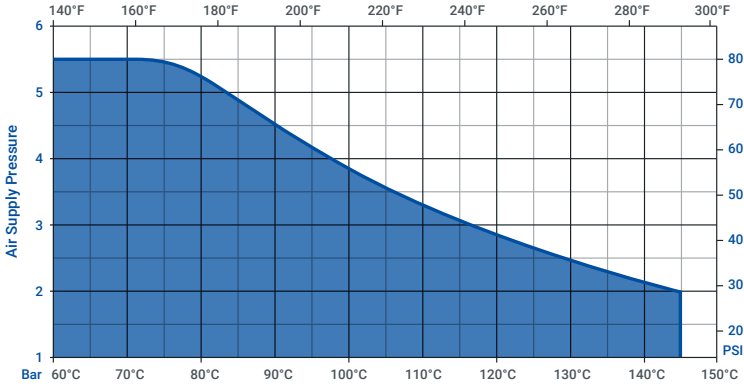

### 1.3 Dimensions

Dimensions in [mm] in

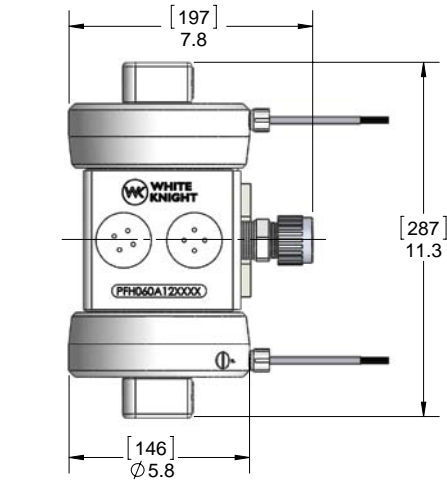

MOUNT WITH 2 EA.  
3/8" (10 mm) SOCKET  
HEAD CAP SCREWS

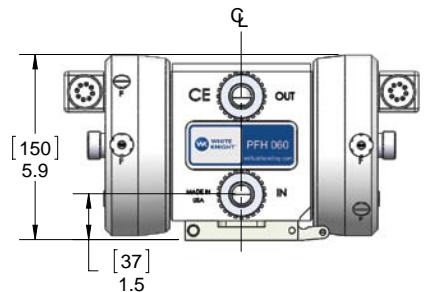
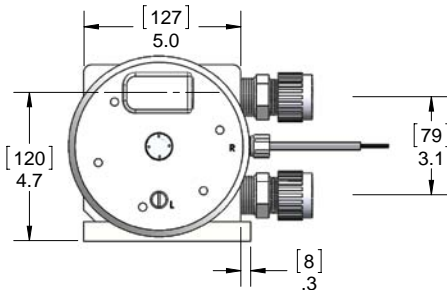
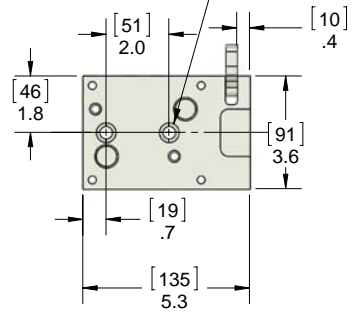



### 1.4 Bill of Materials

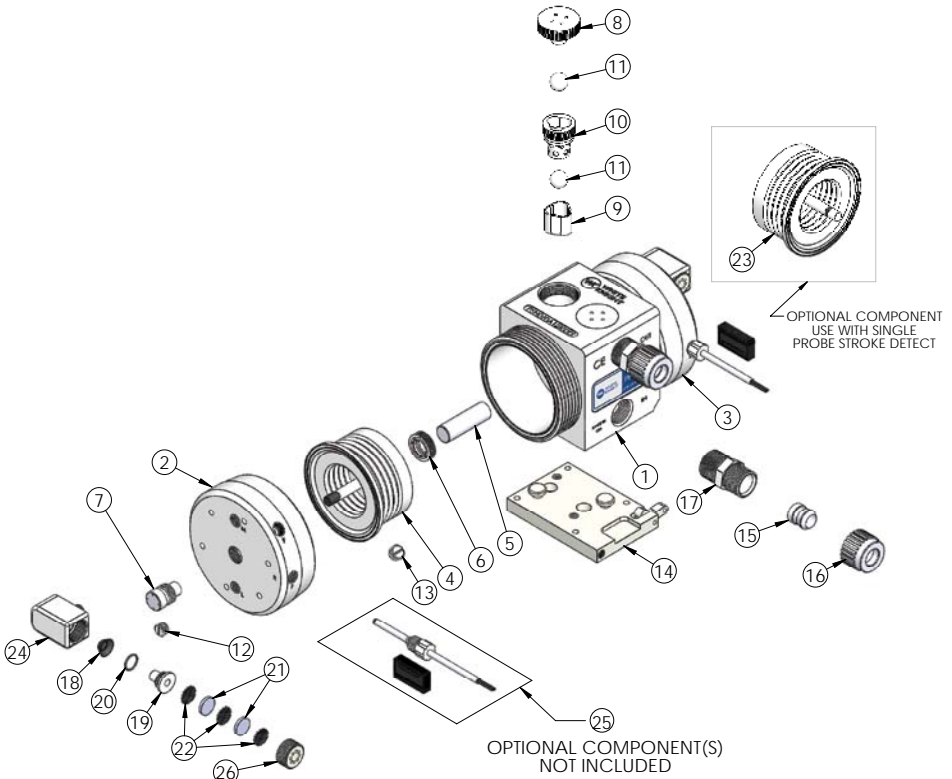

#### PFH060 BILL OF MATERIALS

ITEM NO.	PART NUMBER	DESCRIPTION	QTY.
1	1125-TE-0016	BODY, PUMP	1
2	2127-TE-0025	HEAD, RIGHT, PFH060	1
3	2127-TE-0026	HEAD, LEFT, PFH060	1
4	14300-MP-0024	BELLOWS ASSEMBLY, 60L, FO, DUAL PROBE SINGLE DETECT	2
5	5144-PF-0023	SHAFT	1
6	5143-MP-0002	SEAL, SHAFT	2
7	8100-PF-0002	CAP, END, SINGLE PROBE DUAL DETECT	2
8	4140-TE-0002	TOP CHECK PLUG	2
9	4135-MP-0001	SEAT, CHECK, BOTTOM, HI-FLOW	2
10	4142-MP-0001	CAGE, CHECK, TOP, HI-FLOW	2
11	4100-MP-0001	BALL, CHECK, 3/4"	4
12	10040-TE-0003	PLUG, NPT, 1/4"	2
13	10040-TE-0006	5/8" PLUG SHORT	2
14	14200-NP-0005	PLATE, BASE, ASSEMBLY	1
15	7400-PF-0002	INSERT, S-300®	2
16	7400-PF-0006	NUT, S-300® 3/4"	2
17	7400-TE-0004	BODY, S-300® 3/4"	2
18	3200-VI-0001	DIAPHRAGM, Ø 782	2
19	6150-UH-0001	SEAT, QEV EXHAUST, 30L & 60L	2
20	10080-VI-016-75	O-RING, 016 X .070	2
21	6140-FP-0002	BAFFLE POROUS POLY 30/60 L QEV	4
22	6140-PP-0004	MESH, QEV/04 & 05	6
23	14300-MP-0030	BELLOWS ASSEMBLY, 60L, FO, SINGLE PROBE DUAL DETECT	1
24	6090-UH-0003	BODY, QEH, 05	2
25	14700-XX-0006	STROKE DETECT FIBER OPTIC ASSEMBLY WITH WIRE CUTTER	2
26	6150-NP-0007	CAP, MUFFLER, QEV 30L & 60L	2





## 2. Installation

### 2.1 Precautions

#### Handling

Do NOT lift pump by fiber optic cables, quick exhaust valves nor air tubing.

#### Installation Orientation

PFH060 pumps must be installed in an upright position. The check valves are actuated by gravity and/or flow, and they will not seat if the pump is not upright.

#### Timer Mode

PFH060 pumps require an end of stroke detection mechanism (pressure switch) to prevent over stroking in timer mode. Operating a PFH060 in timer mode without stroke detection will void the pump warranty.

#### Required Air Flow (Shuttle Valve)

PFH060 pumps require 1/4 in minimum orifice with unrestricted air flow.

#### Required Air Flow (Solenoid Valve)

PFH060 pumps require a 1.5 Cv solenoid. Using a reduced Cv will reduce flow rates. Using a valve with more than 20% greater Cv will change operating parameters, reduce pump life and void the warranty.

#### Under Supply of Air

PFH060 pumps operate erratically or stall when air supply is insufficient. Ensure use of air supply pressures higher than averaged air consumption lines in performance charts. Air supply lines and fittings must meet minimal inner diameter requirements shown in the installation instructions.

#### Air Supply Pressure

Operating PFH060 pumps ~35% below max air pressure may significantly extend pump life. PFH060 pumps require 20 psi minimum air pressure. Operation above 5.5 Bar (80 psi) may damage the pump and void the warranty.

#### Suction Lift

PFH060 pumps have an initial suction lift capacity of 3 ft. For best results minimize suction lift.

#### Liquid Inlet/Outlet Connections

PFH060 liquid ports are not NPT nor any other standard. Use of connectors other than those supplied by White Knight will damage the pump and void the warranty.

#### Liquid Line Restriction

PFH060 pumps may be controlled by closing liquid outlet lines. However, restricting liquid supply lines increases wear and should be avoided. Do NOT pump against a closed liquid inlet. It will damage the pump and void the warranty.

#### Running Dry

PFH060 pumps use the pumped liquid to lubricate their shafts. The pumps will cycle faster and wear more than normal when run dry, which may cause damage and loss of self-prime abilities. Standard models should not be run dry after start-up and are not warranted under dry run conditions. Dry-run capable PFHSD060 models may run dry for short periods. Warranty of dry-run models is one-year. Extended warranties are available.

#### Pulse Dampener with Shuttle Valve

Air supply pressure to PFH060 pumps should be at least ten psi higher than the liquid line pressure when using a pulsation dampener. Failure to do so may cause erratic operation.

#### Cross Contamination

PFH060 pumps use porous material that may retain chemicals. Take precautions to avoid cross contamination.



## 2.2 Warnings

### Pressurized Material



Pumps in use contain pressurized materials. Eliminate liquid and air pressure via shut off valves before pump is serviced or removed from the system.

### High Temperature



Heat may transfer to exterior surfaces when pumps operate with high temperature fluids. Avoid direct contact with the pump when high temperature fluids are present.

### Hazardous Chemical



Use appropriate personal protective equipment when handling pump. Reference Material Safety Data Sheet (MSDS) for information specific to your chemicals.

### Loud Noise



Pump exhaust air contributes to work area noise levels. Only operate pumps with approved muffler media, and use ear protection in noisy conditions.

## 2.3 Advantages

### Head Pressure / Dead-Head

PFH060 pumps can be controlled by adjusting their liquid outlet pressures and can be installed with head pressures up to dead-head (e.g. equal liquid and air pressures) with no damage to the pump.

### Thermal Cycling

PFH060 pumps require no maintenance when operated within their performance range, even in thermal cycling applications.

## 2.4 Environment & System

### Oversized Inlet Line

Pumps operate optimally with liquid inlet lines larger than the liquid outlet lines. This reduces strain on the bellows and may reduce pulsation in the pump outlet.

### Clean Supply Air (CDA)

PFH060 pumps require use of Class 2 air for particles and moisture per ISO 8573-1. Use 10 micron filter; maintain -40°C dew point. A point-of-use filter is recommended during first six months of operation in new fabs/systems due to high risks of debris that can damage pumps and void warranty.

### Flammable Solvents

PFH060 pumps are not constructed from conductive materials. System that pump flammable solvents should be properly grounded to avoid ignition by static charge. A River's Edge test of isolative pumps with flammable liquids indicated that liquids must be grounded and other procedures should be followed. Copy of test available.

### Pumping Liquids Near Boiling Point

Minimizing suction lift reduces pulsation and the potential for boiling or outgassing of liquid in the inlet of the pump. Although reciprocating pumps can pull suction lift, pump performance and life increase when suction lift is minimized or eliminated.

### Abrasive Slurry

Pumping abrasive slurry may accelerate wear of components. PFH060 pumps are warranted when used with slurry. However, normal wear is not covered by warranty.

### Environmental Temperature

PFH060 pumps are rated for 0°C (32°F) - 50°C (122°F) environmental temperatures. Do not freeze fluid in pump. Operation below 0°C may accelerate wear. Normal wear is not covered by warranty.



D10 amplifier must be calibrated before attaching fiber optic probes to the pump.

### 2.5 Installation Instructions

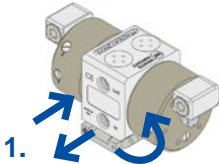

**1.** Set lever to up position. Slide base plate forward or pump body backward.

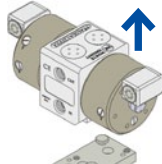

**2.** Lift pump off of base plate.

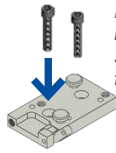

**3.** Screw base plate to surface with 3/8 in or 10 mm head cap socket screws into pre-drilled holes.

*Pull-back dismount is standard. See steps 3.1-3.3 for forward dismount.*

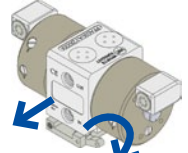

**4.** Set pump on base knobs; slide it forward. Set lever to down position.

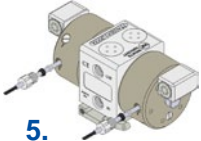

**5.** Insert fiber-optics fully into heads. Push in ferrule and gripper; hand-tighten nut.

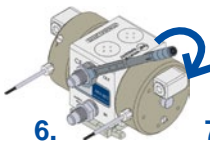

**6.** Attach fittings to pump. Tighten to 55 inch-lbs.

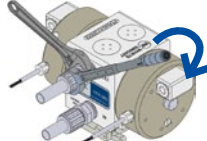

**7.** Attach tubes and fittings per manufacturer instructions. Use backer wrench to hold fittings in place at pump.

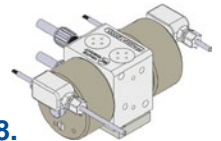

**8.** Set air line via 1/4 in FNPT ports on quick exhaust valves. Line must be 1/4 in minimum orifice.

#### Push-Forward Dismount Configuration Setup

Replace step 4 with steps 3.1-3.3 to re-configure the base plate to push-forward dismount.

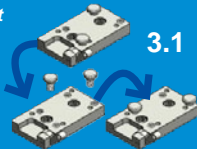

**3.1** Move knobs to opposite sides.

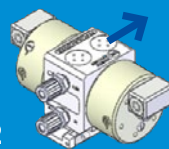

**3.2** Set pump on base knobs; slide it backward.

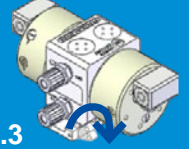

**3.3** Move lever down to locked position.

#### Install with Rigid Base Plate

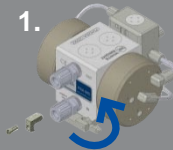

**1.** Remove L bracket. Set lever in neutral (up) position.

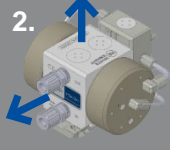

**2.** Slide pump forward; lift it off base plate.

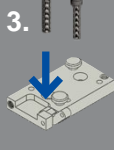

**3.** Fix base plate to work station. See step 4 above.

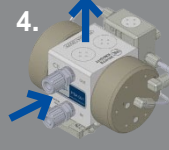

**4.** Return pump to base plate.



**5.** Move lock lever to down position. Reattach L bracket. Tighten hand tight.

#### Liquid Inlet/Outlet

Liquid ports are not NPT nor any other standard. Use of connectors other than those supplied by White Knight will damage the pump.







### 3. Control & Monitoring

#### Programmable Control

White Knight CPT-1 controllers monitor and adjust run mode, flow rate, leak detection and other pump operations.



#### D10 Amplifier Electrical Hookups & Dimensions

White Knight recommends Expert™ D10 amplifier for use with fiber optic stroke and leak detection assemblies.

##### Standard Models and Main Unit

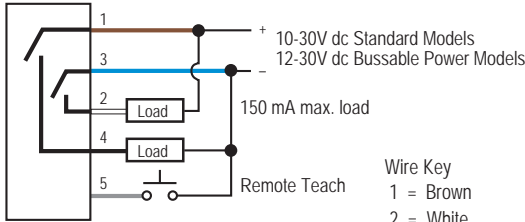

- Wire Key
- 1 = Brown
  - 2 = White
  - 3 = Blue
  - 4 = Black
  - 5 = Gray

QD hookup is functionally identical (Pink wire not used)

##### Sub-Units

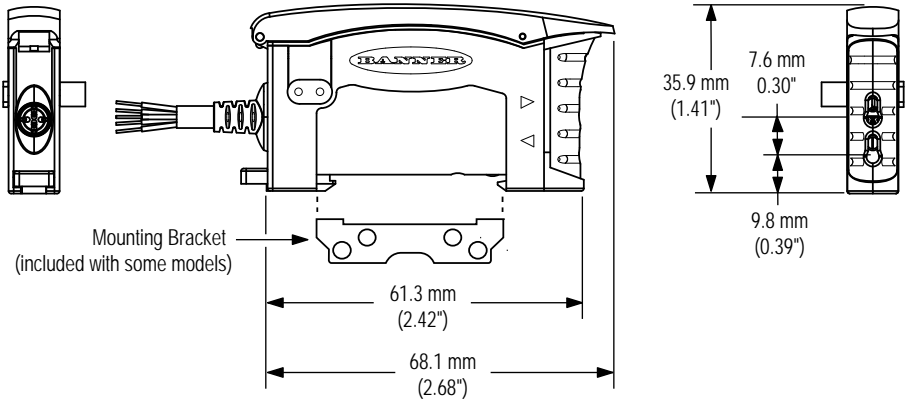
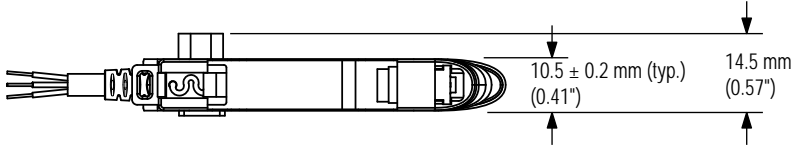
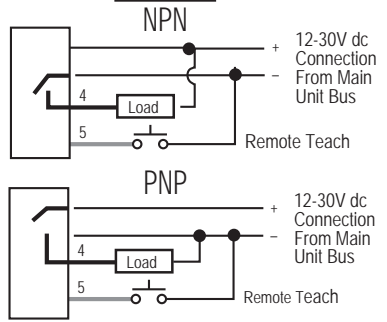



### 3.1 Shift Logic for Fiber-optic Pumps

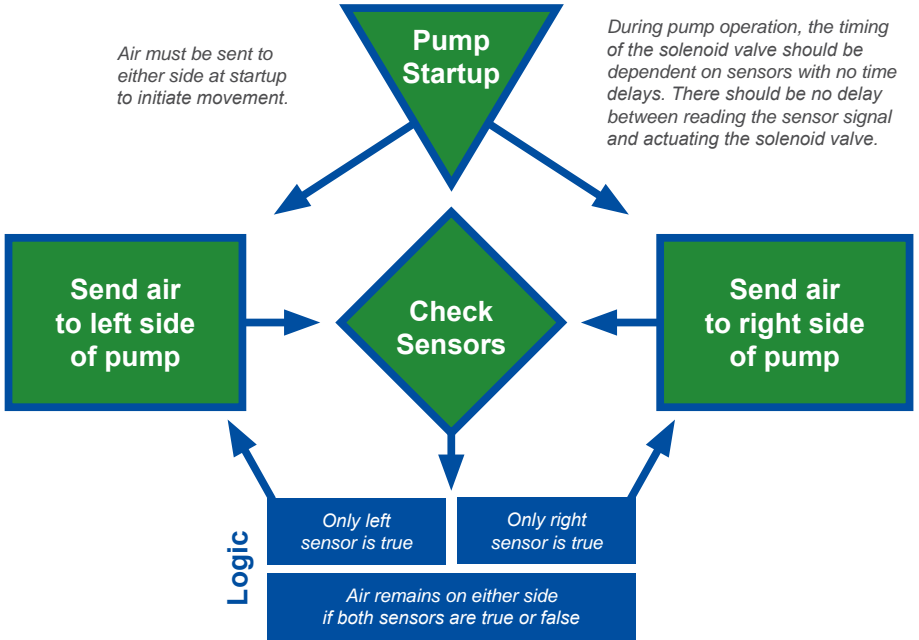



### 3.2 Fiber Optic Stroke Detection Installation

For standard end stroke, follow steps for both sides of the pump.  
For single-probe dual-detect, follow steps for only the left side.

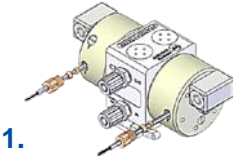

**1.** Insert fiber optic probes fully into heads. Push in ferrule and gripper; hand-tighten nut.

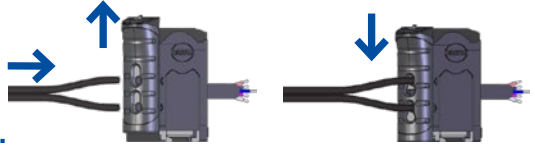

**2.** Open the top and slide the front face of the D10 up. Press the fiber optic ends into the holes on its front. Slide the face down to lock cables in place.

### 3.3 Calibrating D10 Amplifier for Stroke Detection

When calibrating the D10 Amplifier for stroke detection, the pump should be in the same operating conditions it will be in during normal operation (i.e. supply air pressure, back pressure, etc.). The Fiber Optic must be installed as per the instructions in section 3.1.

Calibration:			
	Push Button	Remote Line	Result
<b>Access Dynamic TEACH Mode</b>	Press and hold dynamic push button >2 seconds.	Hold Remote line low (to ground) >2 Seconds.	<ul style="list-style-type: none"> <li>Power LED: OFF</li> <li>Output LED: OFF</li> <li>Bar graph: LO &amp; DO Alternately Flashing</li> </ul>
<b>TEACH Sensing Conditions</b>	<ul style="list-style-type: none"> <li>Hold push button.</li> <li>Operate pump normally for 15 seconds.</li> </ul>	<ul style="list-style-type: none"> <li>Hold remote line low (to ground).</li> <li>Operate pump normally for 15 seconds.</li> </ul>	<ul style="list-style-type: none"> <li>Power LED: OFF</li> <li>Output LED: OFF</li> <li>Bar graph: LO &amp; DO Alternately Flashing</li> </ul>
<b>Return to Run Mode</b>	Release button	Release remote line/switch	Teach Accepted Power LED: ON Bar graph: One LED flashes to show relative contrast (successful setup requires minimum value of 4). Sensor returns to Run Mode with new settings.
			Teach Unaccepted Power LED: OFF Bar graph: #1, 3, 5, 7 alternately flash to show failure to sense. Sensor returns to Run mode without changing settings. Set up again if value shows <4.

Upon completion of a successful learning cycle, the D10 Amplifier will continuously learn and self-teach to maintain the same cycle rate count readings.





### 3.4 Conductivity Leak Detection Installation

Leaks are identified if conductive fluid contacts a sensor. Sensor provides a Sink (NPN) or Source (PNP) signal, depending on the wire setup. See the wiring diagrams below.

*Conductive leak detection does not qualify for use in explosion-proof environments. Conductive fluid required.*

See below for elbow out configuration.

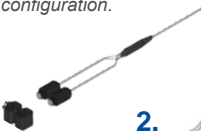
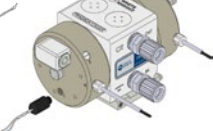
-  Remove leak adapter from assembly.
-  Replace NPT plug in "L" port with probe. Hand Tighten. Attach cable to signal translator (e.g. PLC).

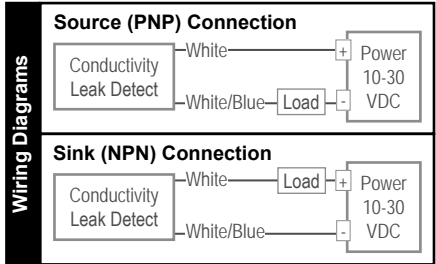

### 3.5 Fiber Optic Leak Detection Installation

*D10 amplifier must be calibrated before attaching fiber optic probes to the pump. Fiber optic sensors can melt if used at >130°C (266°F), causing leak detect failure.*

See below for elbow out configuration.

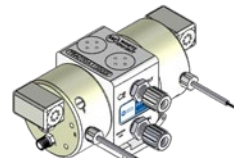
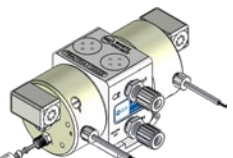
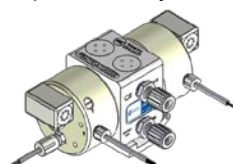
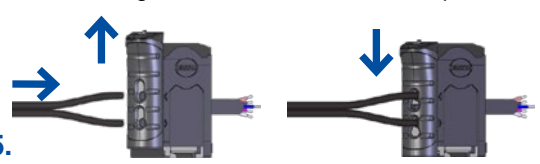
-  Remove leak adapter and leak detect probe from fiber optic assembly.
-  For straight out configuration replace NPT plug in "L" port with the probe. Hand-tighten.
-  Insert the fiber optic cable until it contacts the bottom of the probe.
-  Lower ferrule and gripper until snug against the probe. Hand tighten female gripper nut.
-  Open the top and slide the front face of the D10 up. Press the fiber optic ends into the holes on its front. Slide the face down to lock cables in place.

For elbow out configuration:

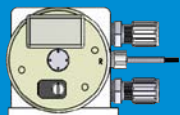
-  Replace NPT plug in "L" port with elbow adapter.

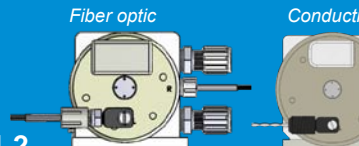
-  Attach fiber optic or conductivity leak detect probe per instructions above.





### 3.6 Calibrating D10 Amplifier for Leak Detection

#### Step 1: Power On D10 Amplifier & Set "Dark Operate" Mode:

	Push Button <i>0.04 s ≤ "Click" ≤ 0.8 s</i>	Remote Line <i>0.04 s ≤ T ≤ 0.8 s</i>	Result
<b>Access Setup Mode</b>	Press and hold both buttons > 2 seconds. 	Double-pulse remote line 	<ul style="list-style-type: none"> <li>Green Power LED turns OFF.</li> <li>Output LED remains active.</li> <li>Icons continue to display current setup.</li> <li>Bargraph turns OFF.</li> </ul>
<b>Select Settings</b>	Press either button until LEDs show desired settings. 	Pulse the remote line until LEDs show desired settings.  Note: Double-pulsing remote line causes setting to "back up" one step.	Sensor toggles through these setting combinations: LO - Normal Speed - No Delay (default) DO - Normal Speed - No Delay LO - High Speed - No Delay DO - High Speed - No Delay LO - Normal Speed - Delay DO - Normal Speed - Delay LO - High Speed - Delay DO - High Speed - Delay
<b>Return to Run Mode</b>	Press and hold both buttons > 2 seconds. 	Hold remote line low > 2 seconds. 	<ul style="list-style-type: none"> <li>Green Power LED turns ON.</li> <li>Sensor returns to Run mode with new settings.</li> </ul>

#### Step 2: Access "Single-Point Dark Set" Mode

	Push Button <i>0.04 s ≤ "Click" ≤ 0.8 s</i>	Remote Line <i>0.04 s ≤ T ≤ 0.8 s</i>	Result
<b>Access Set Mode</b>	Press and hold static button > 2 seconds. 	Single-pulse remote line 	<ul style="list-style-type: none"> <li>Power LED: OFF.</li> <li>Output LED: ON (push button) OFF (remote line)</li> <li>Static LEDs: LO &amp; DO alternately flashing</li> </ul>

#### Step 3: Set Sensing Condition

Set condition to "leak detection" sensing while probe tip is submerged in liquid. Then, remove the leak probe from liquid and reinserted into the "L" port. Amplifier will now signal when moisture is detected on the probe tip.

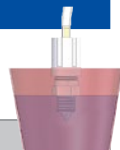

	Push Button <i>0.04 s ≤ "Click" ≤ 0.8 s</i>	Remote Line <i>0.04 s ≤ T ≤ 0.8 s</i>	Result
<b>Set Sensing Condition</b>	<ul style="list-style-type: none"> <li>Present sensing condition</li> <li>Five-click static button</li> </ul> 	Present sensing condition • Five-pulse remote line 	<ul style="list-style-type: none"> <li>Power LED: ON.</li> <li>Output LED: ON (push button) OFF (remote line)</li> <li>Bargraph: 4 indicators flash.</li> <li>Sensor returns to Run mode with new settings</li> </ul> or  <ul style="list-style-type: none"> <li>Power LED: ON.</li> <li>Output LED: ON (push button) OFF (remote line)</li> <li>Bargraph: #1, 3, 5, 7 flash for failure.</li> <li>Sensor returns to Set sensing condition.</li> </ul>











## 4. Pump Service

### 4.1 Ordering Instructions

<https://wkfluidhandling.com/ordering-instructions/>

Select Required Options.  
Only add desired Additional Options.  
Only add Outlet if different than Inlet.  
  
Contact support for revision level or  
copy exact code activation details.

Required Options	Additional Options	Rev.
<b>PFH060 - F12</b> <i>Model Inlet</i>	<b>LF0 - SFD0 - TF12 - A</b> <i>Leak Stroke Outlet QEV Rev.</i>	

Pump Model		
Standard	PFH060	
Dry-Run	PFHSD060	
Inlet Fitting		
Front Straight Only		
Flaretek Compatible 	1/2 in.	F08
	3/4 in.	F12
	1 in.	F16
	1-1/4 in.	F20
Tube Out 	1/2 in.	T08
	3/4 in.	T12
	1 in.	T16
	1-1/4 in.	T20
	Weldable 	3/4 in.
1 in.		W16
Pillar S-300 	1/2 in.	P08
	3/4 in.	P12
	1 in.	P16
	1-1/4 in.	P20
	FNPT 	1/2 in.
3/4 in.		N12
1 in.		N16
Synchro-Flare 	1/2 in.	S08
	3/4 in.	S12
	1 in.	S16
PrimeLock 	1/2 in.	L08
	3/4 in.	L12
	1 in.	L16

Leak Detection	
15 ft fiber optic cable with no amplifier	LF0
15 ft fiber optic cable with D10 amplifier	LF1
25 ft fiber optic cable with no amplifier	LF2
25 ft fiber optic cable with D10 amplifier	LF3
15 ft conductivity cable	LC0

Stroke Detection	
Dual Probe Options	
15 ft fiber optic cable with no amplifier	SFD0
15 ft fiber optic cable with D10 amplifier	SFD1
25 ft fiber optic cable with no amplifier	SFD2
25 ft fiber optic cable with D10 amplifier	SFD3
Single Probe, Dual Detect Options	
Single probe, dual detect, no fibers	SFS
15 ft fiber optic cable with no amplifier	SFS0
15 ft fiber optic cable with D10 amplifier	SFS1
25 ft fiber optic cable with no amplifier	SFS2
25 ft fiber optic cable with D10 amplifier	SFS3







\* Fiber optic cables ordered separately. Fiber optics are required for operation. Standard configuration includes dual probe WITHOUT fibers. See stroke detection options to order fiber optic cables or single probe option.



Timer mode operation requires end-of-stroke detection. Use of timer mode without stroke detection voids the warranty.

This pump includes Quick Exhaust Valves (QEVs). QEVs must be used with this pump. Running it without QEVs voids its warranty. Customers may use their own QEVs with the optional NPT adapter.

Outlet Style	
Front Straight (default)	F
Top Straight	T

Outlet Fitting		
Flaretek Compatible 	1/2 in.	F08
	3/4 in.	F12
	1 in.	F16
	1-1/4 in.	F20
Tube Out 	1/2 in.	T08
	3/4 in.	T12
	1 in.	T16
	1-1/4 in.	T20
	Weldable 	3/4 in.
1 in.		W16
Pillar S-300 	1/2 in.	P08
	3/4 in.	P12
	1 in.	P16
	1-1/4 in.	P20
FNPT 	1/2 in.	N08
	3/4 in.	N12
	1 in.	N16
Synchro-Flare 	1/2 in.	S08
	3/4 in.	S12
	1 in.	S16
PrimeLock 	1/2 in.	L08
	3/4 in.	L12
	1 in.	L16

Quick Exhaust/Air Inlet	
5/16 in NPT Adapter	A





### 4.2 Rebuild Information

Pumps fully rebuilt by White Knight, certified rebuilders, or technicians certified by White Knight receive full warranty renewal. Details below.

#### White Knight Rebuilds

Request factory rebuilds by web form at: <https://wkfluidhandling.com/support/rma/>. An RMA# will be provided after processing.

*\*Customers must follow decontamination instructions in Section 4.4 when returning a pump to White Knight.*

#### Certified Rebuilders

White Knight's global network of certified rebuilders expedite rebuild turn-around time and minimize shipping costs. Find certified rebuilders at: <https://wkfluidhandling.com/rebuilders/>

#### Rebuild Pump as Certified Technician

White Knight offers trainings to certify technicians to rebuild pumps. Technicians who pass the training are issued a two-year certification. During the two years, parts in pumps rebuilt by the technician receive a full warranty. See: <https://wkfluidhandling.com/virtual-rebuilds/>

### 4.3 Rebuild Kits & Parts

Rebuild kit for PFH060 is RBPFFH060-1. Rebuild kit for PFHSD060 is RBPFHSD060-1 (labor not included). To request rebuilds by White Knight, use RBPFFH060-5 or RBPFHSD060-5, respectively (labor included).

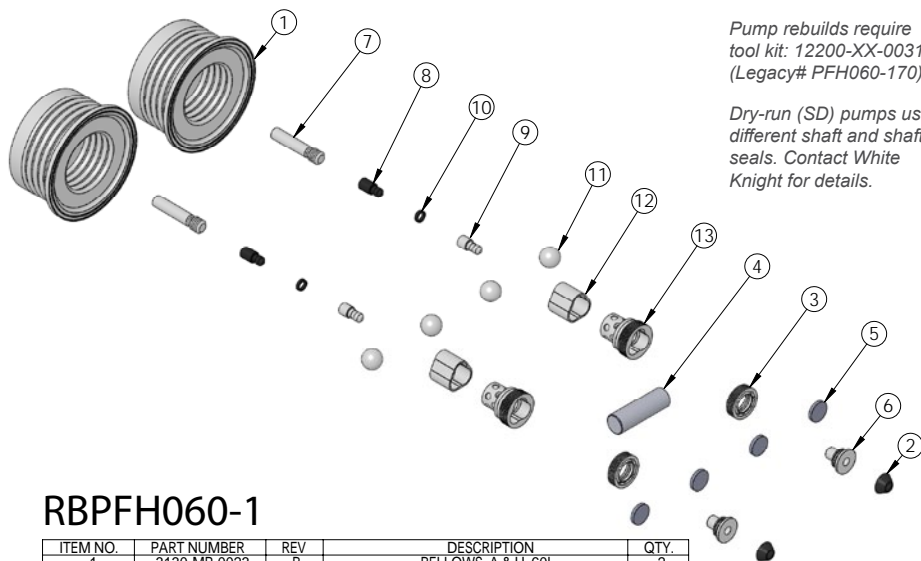

Pump rebuilds require tool kit: 12200-XX-0031 (Legacy# PFH060-170)

Dry-run (SD) pumps use different shaft and shaft seals. Contact White Knight for details.

### RBPFFH060-1

ITEM NO.	PART NUMBER	REV	DESCRIPTION	QTY.
1	3130-MP-0023	B	BELLOWS, A & H, 60L	2
2	3200-VI-0001	B	DIAPHRAGM, Ø.782	2
3	5143-MP-0002	A	SEAL, SHAFT, A&H, 60L	2
4	5144-PF-0023	A	SHAFT, SOLID, PFA, 60L	1
5	6140-FP-0002	A	BAFFLE, .800"	4
6	6150-UH-0001	B	SEAT, QEV EXHAUST, .30L & 60L	2
7	8140-TE-0005	B	STEM, SD TARGET, .60L	2
8	8150-BP-0001	A	EXTENSION, TARGET, UNIVERSAL	2
9	8150-TE-0005	A	EXTENSION, TARGET, .145	2
10	8160-BP-0005	A	BLANK, TARGET, .145	2
11	4100-MP-0001	A	CHECK BALL-3/4"	4
12	4135-MP-0001	A	BOTTOM CHECK SEAT- 10GPM HIGH FLOW	2
13	4142-MP-0001	A	TOP CHECK CAGE-10GPM HIGH FLOW	2





## 4.4 Return Pump for Service

Follow decontamination instructions when returning a pump for service.

**DO NOT REMOVE PAGE FROM MANUAL.**

Copy page from manual or download at <https://wkfluidhandling.com/support/rma/>.

# Decontamination Instructions

**PRINT COMPLETED DECONTAMINATION CERTIFICATION. IT MUST BE INCLUDED IN YOUR RMA SHIPMENT.**

White Knight products are designed for use with caustic and otherwise dangerous liquids. Handle every product as if it contains dangerous chemicals whether or not it actually does.

- Only those with adequate safety training should attempt to handle used pumps.
- Wear adequate safety gear appropriate for chemicals that have been in the pump.
- Review relevant Material Safety Data Sheets (MSDS) before handling the pump.
- Review emergency numbers for use in event of an accident.
- Prepare Ph papers, showers, antidotes, clean-up equipment, neutralizers, and other safety devices used to detect, neutralize or minimize effects of chemicals described in appropriate MSDS documents.

## Rinse with DI Water

Circulate DI water through pump for twenty minutes before disassembly and/or double bagging for shipment. If pump is nonfunctional, force DI water from inlet through outlet for 40 minutes before shipment preparations.

## Remove Pump from Station:

1. Disconnect liquid tubing connectors from front of pump (opposite shuttle valve).
2. Plug NPT fittings with PTFE plug, Flare fittings with flare nose cover and cap, or other plug or cap as recommended by connector supplier.
3. Disconnect air supply tubing from face of shuttle valve.
4. Loosen mount screw from base plate. (Note: do not remove screw from base plate).
5. Remove base plate using proper tool for the fastening devices (e.g. Allen wrench or screw driver).  
Note: Base plate may stay if needed for replacement pump to be used.
6. Return all removed parts to the pump.

## Return Pump to White Knight:

1. Rinse pump with DI water as described above after removing it from its station.
2. Drain remaining DI water from the pump inlet and outlet liquid tubing connectors.
3. Plug liquid outlets as described in the Remove Pump from Station section above.
4. Dry the pump, double bag it, and seal it in thick polyethylene bags.
5. Return the pump to its original packaging.
6. Include MSDS for the chemical that the pump was handling in the box with the pump.
7. Obtain RMA number from White Knight and write it on the outside of the box.
8. Ship to White Knight following all rules, regulations and laws regarding shipment of dangerous materials. Ship freight pre-paid. No collect shipments will be accepted. Unauthorized use of White Knight shipping accounts will result in the adding of freight to the bill in addition to a service charge.

## Include All Pump Components:

Pumps returned to White Knight for evaluation, service or repair must be complete with all components, including but not limited to base plate, mount screws, tubing connectors, tubing connector caps, flare noses, shuttle valves, mufflers, and tubing. Missing parts will be added to the pump and charged to the customer.







**DO NOT REMOVE PAGE FROM MANUAL.**

Copy page from manual or download at <https://wkfluidhandling.com/support/rma/>.

## Decontamination Certification

**COMPLETE AND PRINT THIS FORM. IT MUST BE INCLUDED IN YOUR RMA SHIPMENT.**

I, the undersigned employee of \_\_\_\_\_, certify that all decontamination and safety procedures described in Decontamination Instructions section have been followed for return of product below.

**RMA#:** \_\_\_\_\_

*(We cannot process returns without an RMA number.)*

**Serial#:** \_\_\_\_\_

*(We cannot process returns without a product serial number.)*

### **Metal Exposure:**

*(Check all that apply. Write in other metals if necessary.)*

Product was used in a Metal Process.     Yes     No

Product was used in a Copper Metal Process.     Yes     No

Product was used with:

- Aluminum     Cobalt     Gold     Lead     Nickel     Platinum     Silver     Tin     Titanium
- Tungsten     Zinc     Other: \_\_\_\_\_

### **Chemical Exposure:**

*(Check all that apply. Write in other chemicals if necessary.)*

Product was **NOT** used in chemicals (DI Water only).

Product was used in chemicals.

- Ammonia     Ammonium Hydroxide     Hydrochloric Acid     Hydrofluoric Acid     Hydrogen Peroxide     IPA
- Nitric Acid     Phosphoric Acid     Sulfuric Acid     Other: \_\_\_\_\_

### **Shipping Information:**

Please indicate metal processes to which the product has been exposed by clearly and conspicuously labeling the outside of the return package with the metal.

**Products exposed to Metal Processes must be sent to the following address:**

White Knight Fluid Handling  
187 East 670 South, Suite B  
Kamas, UT 84036

**Products NOT exposed to Metal Processes must be sent to the following address:**

White Knight Fluid Handling  
187 East 670 South, Suite C  
Kamas, UT 84036

Print Name: \_\_\_\_\_

Signature: \_\_\_\_\_

Date: \_\_\_\_\_





## 5. Warranty

White Knight follows strict manufacturing, assembly and testing procedures to ensure consistency and reliability.

White Knight warrants PFH060 pumps and components are free from defects in materials and workmanship for two years from our shipment date or your installation date if provided within 90 days of shipment from our facility.

Failures due to normal wear, misuse, abuse or unauthorized disassembly nullify this warranty.

White Knight does not guarantee the suitability of products for specific applications. White Knight is not liable for any damage or expense resulting from use or misuse of its products in any application. Responsibility is limited solely to repair or replacement of defective products or components.

Prior written, faxed or emailed approval must be obtained from White Knight before returning any product or component for warranty consideration. All determinations regarding cause of failure are made by White Knight, and all decisions regarding warranty fulfillment or nullification are made by White Knight.

THE FOREGOING WARRANTY IS EXCLUSIVE AND IN LIEU OF ALL OTHER WARRANTIES EXPRESSED OR IMPLIED, INCLUDING ANY GUARANTEE OF SUITABILITY FOR ANY PURPOSE. NO VARIATIONS OF THIS WARRANTY SHALL BE HONORED NOR CONSIDERED LEGALLY BINDING, EXCEPT WRITTEN AGREEMENTS SIGNED BY THE CEO OF WHITE KNIGHT FLUID HANDLING.

Steve Smith, CEO  
White Knight Fluid Handling

## Accessories

*See ordering instructions or contact us for details.*

### Stroke Detection

- Fiber Optic stroke detection with or without sensor
- Solid state pressure switch
- Solid state dual pressure switch

### Leak Detection

- Fiber Optic leak detection with or without sensor
- Conductivity leak detection

### CPT-1

- Control/monitor run mode and flow rate.

### Catcher™ Pre-Filters

- In-line and pump-mounted options
- Large through holes to avoid loading
- Filter may be removed without removing the Catcher™ from the pump or the line.
- Pumps damaged by passing solids that use a Catcher™ are repaired as in warranty.

### Filter Housing

- 100% non-metallic
- Allows for filter changing without disconnecting the inlet/outlet lines
- Rated for temperatures up to 210°C
- Install with industry standard connections
- Designed to allow for thermal cycling
- Upright and inverted installation options

### Quick Exhaust Valves

- Allows for immediate escape of exhaust air reducing pulsation and exposure of solenoid valve to corrosive fumes
- In-line and pump-mounted options
- UHMW-PE design
- Comes standard with a one-year warranty

### Pulse Dampeners

- Uses same CDA as supplied to pump
- In-line and pump-mounted options
- Sizes available for all PFH Series pumps
- Self-adjusting, Auto-Level Valve is regulated by liquid line pressure



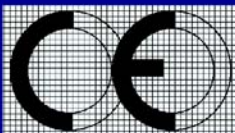

**Barclay-Phelps**

CE MARKING SPECIALISTS  
Hoi Yuen Road, Kwun Tong, Kowloon, Hong Kong

**CERTIFICATE & DECLARATION OF CONFORMITY FOR CE MARKING**

**Company contact details:**  
White Knight Fluid Handling Inc.  
187 E. 670 S., Kamas, Utah, 84036, USA

**White Knight Fluid Handling Inc. declares that their:**

Bellows Pump Line

PSA030, PSA060, PSA140, PSH030, PSH060, PSH140, PSU030, PSU060, PSU140, PSA015, PSR050, PSR025, PFA030, PFA060, PFA140, PFH030, PFH060, PFH140, PFU030, PFU060, PFU140, PXA030, PXA060, PXA140, PXH030, PXH060, PXH140, PXU030, PXU060, PXU140, PFA015, LHA015, LHA030, LHA070

Diaphragm Pump Line (Non Conductive)

PSD04TE, PSD06TE, PSD08TE, PSD16TE, PSD24TE, PSD04UH, PSD06UH, PSD08UH, PSD16UH, PSD24UH, PSB100

Diaphragm Pump Line (Conductive)

PSD04TC, PSD06TC, PSD08TC, PSD16TC, PSD24TC, PSD04UC, PSD06UC, PSD08UC, PSD16UC, PSD24UC

Legacy Pump Line

PLS30, PLS60, PLS120, PLX30, PLX60, PLX120, PX30, PX60, PX120, PLF30, PLF60, PLF120

Metering Pumps

PPM100, PEM100, PEM050

Plastic Pumps

PHC40-2, PPMC300, PPMA

TPA07 Pressure Transducer

**are classified within the following EU Directives as applicable:**

Machinery Directive 2006/42/EC

Low Voltage Directive 2014/35/EU

Electromagnetic Compatibility Directive 2014/30/EU

RoHS 2 Directive 2011/65/EU

**and further conform with the following EU Harmonized Standards as applicable:**

EN 809:1998+A1:2009 EN 60204-1:2006 + A1:2009 EN 61000-6-2:2005 EN 61000-6-4:2007+A1:2011

**Dated:** 16 January 2017

**Position of signatory:** Product Manager **Name of Signatory:** Cory Ammon Simmons

**Signed below:** on behalf of White Knight Fluid Handling Inc.





**WHITE  
KNIGHT®**

.....*engineer approved™*

**White Knight Support**

187 E. 670 S.  
Kamas, UT 84036

Phone: 435.783.6040  
Toll Free: 888.796.2476  
Fax: 435.783.6128

[support@wkfluidhandling.com](mailto:support@wkfluidhandling.com)  
<https://wkfluidhandling.com/support/>



Part No. 18200-LM-0015



Copyright © 2018 White Knight Fluid Handling | A Graco company  
P: 435.783.6040 | [support@wkfluidhandling.com](mailto:support@wkfluidhandling.com) | <https://wkfluidhandling.com>

Version 2.0.9 | 2 May 2018  
Subject to change without notice