

WHITE KNIGHT

PL120 Owner's Manual

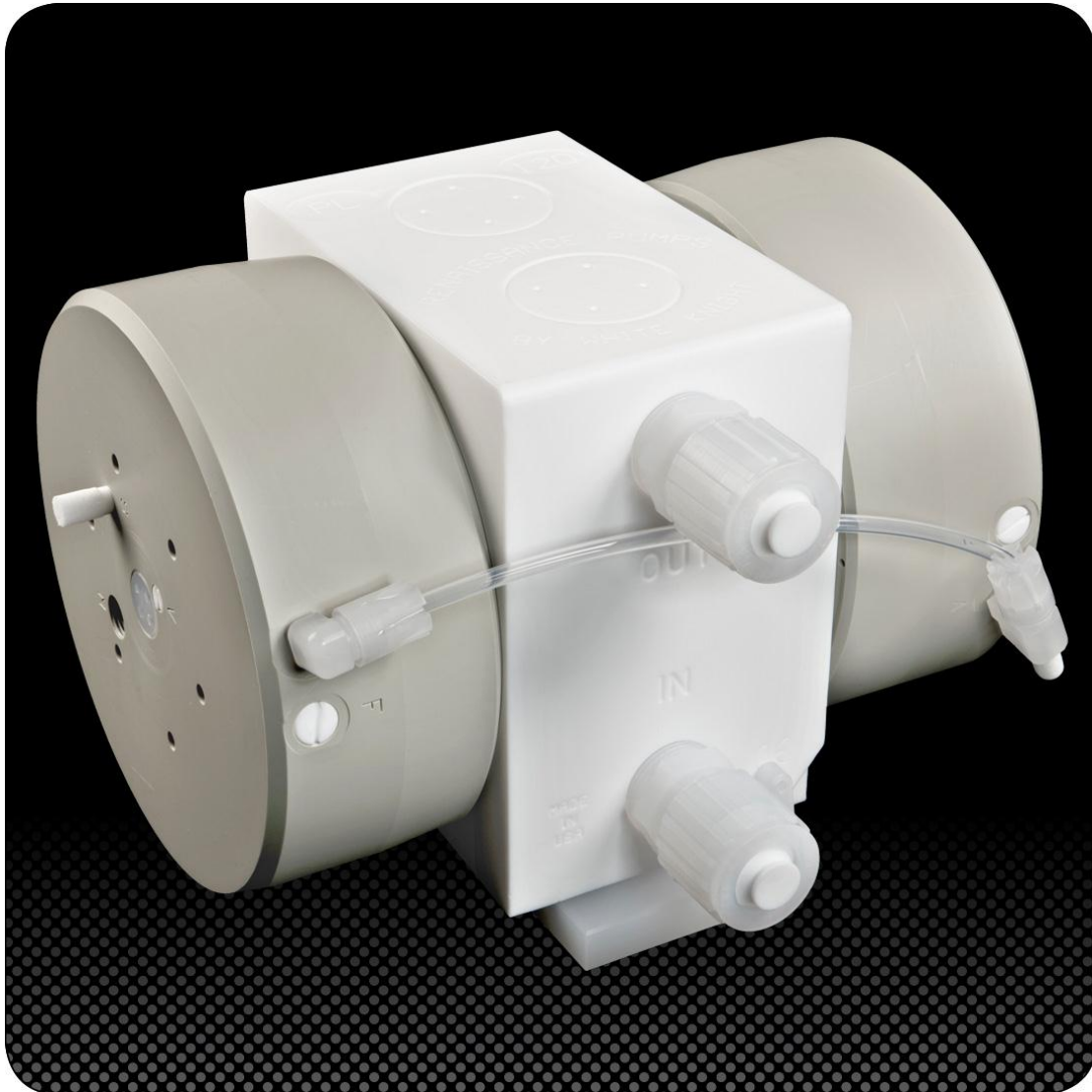

**WHITE
KNIGHT™**

White Knight Fluid Handling Inc.

187 E 670 S Kamas, Utah 84036 USA

Phone 435.783.6040 • Fax 435.783.6128 • Toll Free 888.796.2476

wkfluidhandling.com

TABLE OF CONTENTS

Recommended Mode of Installation	4
When Replacing a Competitor's Pump	8
Cautions on Installation	10
Exploded View	11
Installation Instructions	12-13
Leak and Stroke Detect Port Locations	14
Footprint	15
Flow Curves	15
Air Consumption	16
Air Supply Pressure to Temperature Limits	16
Rebuild Information and Options	17
Trouble Shooting	17
Decontamination Instructions	18
Ordering Instructions for Renaissance 120 series pumps	19
Rebuild Service or Kit Ordering Instructions	22
Warranty	23
Pulsation Dampening	24-27
Other Accessories	28
Electronic Accessories	29
Decontamination Certificate	30

Pricing and other information contained within this owner's manual is subject to change without notice.

Congratulations!

You are about to install a pump that has become legendary in the high purity chemical pumping industry. White Knight is a leader in no metal high purity pumps and continues to drive the industry with new technology. Since the inception of White Knight in 1995, we have been awarded an impressive 10 US patents for our designs, with multiple other foreign and domestic patents pending! Currently, White Knight produces over 20 size/model combinations of zero metal high purity pumps, far more than any other producer of high purity pumps anywhere. That equates to an average of over three new pumps per year! White Knight has also been the recipient of multiple prestigious industry awards for its designs.

Other than PFA tubing and a few ceramic and electronic assemblies and components, all parts of White Knight pumps are manufactured right here at our plant in Kamas, Utah. This allows us to be rigorous in our quality assurance process where almost all processes are performed right here at White Knight. White Knight molds its own PTFE and machines all of its own PTFE, PFA, and plastic components. This ensures that strict cleanliness procedures are always followed and that components are built under consistent methods and conditions to make our products as reliable and consistent as possible.

Your new pump was assembled and tested in a class 100, temperature and humidity controlled cleanroom. It successfully underwent a battery of tests and was then dried out and double bagged in the cleanroom to ensure cleanliness and its operational integrity.

Before installing your White Knight pump please carefully review this owner's manual. There are many helpful hints and ways to optimize the installation of your White Knight pump as well as instructions and requirements for installation and use.

White Knight also provides many accessories that will enhance the abilities of your White Knight pump. Many of these are briefly described in this manual.

We have gone to great lengths to provide you with what we believe to be not only the best value for the money in high purity pumps, but the best high purity pump period. We hope that you agree.

John Simmons
President, White Knight Fluid Handling, Inc.



Recommended Mode of Installation New System Design

The following is an attempt to go over some basic physics of White Knight pumps so that care may be taken in the design phase of equipment or applications wherein White Knight pumps are used. Following the principles described in this document will ensure the most practical and reliable installation of White Knight pumps, though it is understood that the ideal mode may not always be possible.

Several principles should be understood before proceeding.

- **SUCTION LIFT:** Any air driven pump pushes better than it lifts. This means that if you have to move liquid up ten feet, that the pump will move more liquid faster (and in most cases the pump will be more reliable) if the pump is installed at liquid level and is allowed to push the liquid up the ten feet. Rather than being installed at the ten foot level to lift liquid up to the delivery level. The same should be said for long runs. The best installation is with the pump as near the source as possible.
- **RESTRICTION OF LIQUID INLET LINE:** Restricting the liquid supply of the pump causes the pump to work harder and should be avoided when possible, particularly in the event of pumping more viscous liquids.
- **UNDER SUPPLY OF OPERATIONAL AIR:** Under supplying of air to an air driven pump can cause a pump to run erratically. Air driven pumps vary throughout the cycle as to how much air they require. Though the rate of air usage is averaged for air usage charts, if the bare minimum air supply (as shown on the charts) is provided, there are fractions of seconds during a cycle where a pump would be “starved” for air. This could cause a pump to run erratically or to stall. In many instances, it could effect the ability of the pump to self-prime. White Knight publishes the size of air line orifice for all of its pumps to avoid this situation. These sizes are listed on the “Warning” sheet shipped out with every pump and included in this manual.
- **DRY RUNNING:** While the consequences vary from model or brand of air driven pump, it is always best to limit the amount of dry running that the pump is required to perform. The worst case is in the instance of pumps with wetted shafts such as the White Knight AT, AP, APFM, and Renaissance

series as well as some other brands of air driven pumps. Pumps with wetted shafts use the liquid that they are pumping to lubricate the shaft and seals. When these pumps are run dry, they are not receiving sufficient lubrication to keep abnormal wear from the shaft and/or seal. When this occurs, the pump gradually loses its ability to self-prime. It is White Knight's recommendation that all air driven pumps with wetted shafts be installed in a flooded style (with gravity feeding liquid to the pump). This does not mean that the pump *must* be installed in a flooded style, remember that we are talking about "ideal" conditions. It should also be understood that when any air driven pump is running dry, it is cycling faster than it would be if it were pumping liquid. This means that in the same amount of time, a pump running dry will achieve a higher number of cycles against its life expectancy than a pump that is pumping liquid, thereby shortening (in time) the life of the pump.

- **HEAD PRESSURE:** While some air driven pumps common to the high purity chemical industry limit the percentage of head pressure (amount of liquid line pressure that the pump is pumping against) to air supply pressure, no White Knight pumps are restricted in any such way. White Knight pumps can be installed in any head pressure situation up to dead head (liquid line pressure equaling air supply pressure, which equates to no flow). White Knight pumps come standard to work in high back pressure situations. For applications where high head pressures are needed the Renaissance series of pumps are recommended as they are capable of running at air pressures of up to 100 PSI.
- **DEAD HEAD:** Though some air driven pumps in the industry do not allow it, White Knight pumps can actually be controlled by opening and closing the outlet line of the pump.
- **CLOSED OR PLUGGED LIQUID INLET LINE:** Air driven pumps should not be controlled by closing the liquid inlet line to the pump. This causes undue stress on bellows or diaphragms, and in many cases can cause a pump to "race" thereby subtracting cycles from its life expectancy at an alarming rate.
- **ORIENTATION:** While it is possible to install air driven pumps in other than up right positions in flooded suction circumstances, it is not recommended. Check valves within White Knight pumps are actuated by gravity and/or flow. Therefore, a pump installed in the upright position would run more efficiently than a pump that was installed in another way. A White Knight (and most other air driven pumps in the high purity chemical industry) will not prime themselves if installed in any way other than upright (within a few degrees).
- **THERMAL CYCLING:** Some pumps in the industry have limits on or special maintenance requirements for pumps in conditions that thermal cycle. No White Knight pumps have special requirements for thermal cycling applications, but pumps must be operated within their respective temperature to pressure limitations.

- **SUPPLY PRESSURE RECOMMENDATIONS:** While all manufactures of air driven pumps set a limit (red line) on how much air pressure can be used for pump operation, it is always best to operate a pump at lower than red line supply pressures. Life expectancy goes up as supply pressure goes down. The life of many air driven pumps goes up significantly if the pump is operated at between 60%-70% of red line pressures, particularly in open loop systems where there is very little head pressure to slow pump cycling.
- **PASSING SOLIDS:** In any instance where pumps are installed in an application where solids could be introduced into the liquid, a pre pump filter such as the White Knight **Catcher™** should be installed in the inlet line going to the pump. These pre pump filters are designed to catch solids before they get to the pump where they could damage bellows, diaphragms, or other parts of the pump. Of particular concern are shards from broken wafers in semiconductor manufacturing. Care should be taken in selecting the pre pump filter. Some pre pump filters have a very fine screen that screens out anything that could damage a pump, but screens this fine come with other problems. Some chemistries including but not limited to sulfuric acid and phosphoric acid can begin to produce crystals similar in size and shape to table salt crystals. Such crystals can plug up the screen and cause undue stress to the pump, particularly to bellows or diaphragms. White Knight does not cover such damage under warranty. While there is no perfect size of screen that keeps out the bad without plugging up, the best scenario is to use White Knight **Catcher™** pre pump filters. With the **Catcher™** the screen is large enough to keep from becoming plugged in normal industry conditions. And, when a **Catcher™** is used in conjunction with a White Knight pump, if a solid passes through the **Catcher™** and damages the pumps (very unlikely) White Knight will repair the pump under warranty.
- **OVERSIZED INLET LINE:** White Knight pumps (as well as many other air driven pumps) are best installed with liquid inlet lines larger than the liquid outlet lines, particularly in open loop systems where there is very little head pressure. This reduces strain on bellows and diaphragms and also in many cases reduces surge in the outlet line from the pump.
- **PULSATION:** White Knight pumps are famous for the low surge created in outlet lines down stream from the pump. However, there are things that can be done to reduce surge even further. White Knight offers Flatliner™ Pulsation dampeners in various sizes to minimize surge created by air driven pumps. In open loop systems where there is very little head pressure, most White Knight customers find it unnecessary to use additional pulsation dampening devices, however, as head pressure increases, the requirement for pulsation dampening increases. A less expensive way to lessen pulsation in the outlet line is by the usage of a “stand tube”. This is accomplished by installing a Tee in the outlet line from the pump. The Tee is pointed upward and a piece of tubing (typically 3-4 feet long) is stood up and capped. As the

pump runs, the liquid pressure in the line compresses the air in the stand tube during the pressure part of the pump stroke and the compressed air in the stand tube pushes liquid back into the line during the shift part of the pump cycle. These stand tubes are pretty effective, however, they must be monitored and from time to time the cap may need to be removed to allow the tube to release liquid and refill with air.

- **LEAKY LINES:** All liquid tubing connectors upstream and downstream from the pump should be tight and leak proof. But on the inlet side of the pump, a leak may not be noticed, as if the leak is sufficiently large, the pump will simply not prime. Select a quality type of liquid connection throughout your system and make sure that they are installed properly.
- **BOILING LIQUID:** In the event of pumping chemistries at or near their boiling point, it must be remembered that the boiling temperature of any liquid reduces under vacuum conditions. As a pump sucks liquid into it, the liquid in the supply line to the pump is under a vacuum condition. Depending on the amount of vacuum and the temperature of the liquid, liquid could boil in the outlet line of the pump when it is not boiling in the tank (or other supply reservoir). Placing the pump as close as possible to the tank and with as little vertical lift as possible (the pump being flooded by gravity is ideal) minimizes boiling in the inlet line. Boiling of the liquid in the inlet line causes a pump to “race” thereby shortening its life, and in extreme circumstances will cause the pump not to prime.
- **FLAMMABLE SOLVENTS:** High purity pumps are frequently used to pump flammable solvents. Any system used to pump flammable solvents should be properly grounded to avoid ignition by static charge. Where high purity pumps are constructed from insulative materials (PTFE and PFA) grounding the pump is not sufficient. A test from River’s Edge on using insulative pumps to pump flammable liquids indicated that the liquid itself must be grounded and that other procedures should be followed. A copy of the test is available from our web site or may be acquired by calling or emailing us at White Knight. Designs planning the use of any insulative type pump for use with flammable solvents should only be done by those having proper training and understanding of the effects of static electricity buildup in such systems.
- **CLEAN SUPPLY AIR:** White Knight (as well as many other high purity air driven pumps) require the use of CDA (Clean Dry Air) (Solids: No more than 1PPM with size no more than 1.0um Moisture: No more than 1PPM Oils: No more than 1PPM) or nitrogen. Use of supply air that does not meet these specifications could result in close tolerance parts of the pump shifting mechanisms to seize.
- **ABRASIVE SLURRIES:** Pumping of abrasive slurries will shorten the life of any pump. Pumps are still warranted when used in abrasive applications,

however components that wear with use, will wear faster. Normal wear is not a condition covered by warranty.

- **CROSS CONTAMINATION:** When replacing pumps in existing systems, care should be taken to avoid cross contamination. PTFE (and for that matter all plastics as well) are porous. As a high purity pump is run in a chemistry, that chemistry is retained in the pores of the material. This situation is increased if the pump is used in a thermal cycling application. This being the case, care should be taken to keep a record of which pumps (White Knight and most other high purity pump suppliers serial number each pump) have been in which chemistries and then should be used only in the same chemistry to avoid cross contamination.
- **PUMP MONITORING:** Pump monitoring can be performed by several methods such as Fiber Optic stroke detection (special pump heads required) or Solid State Pressure Switch monitoring which can be installed on any White Knight pump. These options are described on our web site in the options section and are available through our authorized distributors.
- **LEAK DETECTION:** Several types of leak detection are also available from White Knight including **Bubble In – Bubble Out™** and fiber optic air side leak detection. These products are also described on our web site and are available through our distributors.
- **PROGRAMABLE CONTROLLING:** White Knight has developed the **Merlin™** pump controller that can be used to program a White Knight pump. Run time and volume “recipes” can be programmed into the **Merlin™** to control any White Knight pump.

Things to Watch For When Replacing Our Competitor's Pumps

- **AIR UNDERSUPPLY:** Some other air driven pumps used in pumping high purity chemistry are not as sensitive to air under supply as the White Knight pumps are. Make sure that if you are replacing a competitor's pump with a White Knight pump that the proper sized air line is used. This information is contained on a page called “warning” which is sent out with every White Knight pump, is included in this manual and is also available from our web site.
- **INLET/OUTLET CONFIGURATION:** Most other air driven pumps used in high purity applications are very particular in their connections to liquid inlet and outlet for the pump. Many configurations are available on all White Knight pumps and in most cases we can attach to liquid lines in a very similar orientation and connection type as the pump that you have been using. A list

of options is available in the ordering section of this manual and on our web site under ordering instructions for each of our respective pumps, or contact a White Knight representative for assistance.

- **PUMP MONITORING AND TRANSLATION:** Many tools monitor a pump while it is running and have alarms set for when pumps cycle too fast or too slow, which could indicate a problem. White Knight pumps can use several types of monitoring that provide a signal back to the tool that allows monitoring of the White Knight pump. The problem is that no two brands or models of pumps have the same displacement per stroke. This means that if upper or lower limits are set in a monitoring system and a different brand or model of pump is installed, that alarms could be immediately thrown. There are two ways to overcome this problem. First of all, the alarms set in the tool or its monitoring system can be reprogrammed. The biggest problem with this option is that many times if a tool is upgraded with manufacturer's software later on the alarms are re-set. This can also cause problems with the same tools in one area running different pumps, especially in the event of a gradual change out. Different tools with different needs for programs can become hectic. Because of this, White Knight developed **Merlin™** pump translators. **Merlin™** pump translators are programmable at the White Knight factory or by the user with the purchase of an additional kit. The **Merlin™** pump translators are capable of converting output to a fractional derivative of actual operation based on displacement in order to provide monitoring information back to tool similar to what signals would have been with other pump of different displacement at similar flow. This eliminates the need for reprogramming alarms in most instances.
- **PULSATION DAMPENING:** When replacing one of our competitors' pumps for reasons of potential metal contamination take care to eliminate any other source of potential metal contamination that you can. In many instances when replacing a competitive pump with a White Knight, pulsation dampeners that have been required before are no longer needed due the low pulsation created by White Knight pumps. If this is the case, remove any pulsation dampeners that have metal parts in them and discard them. If pulsation dampening is still required, replace the pulsation dampener with a zero metal pulsation dampener such as the White Knight Flatliner™ pulsation dampener.
- **PASSING SOLIDS:** Make sure that if there is a potential for solids (such as wafer shards) to be introduced into the liquid that the pump will be pumping that a suitable pre pump filter such as the White Knight Catcher™ is installed. White Knight warrants all White Knight pumps against passing solids when used in conjunction with a Catcher™.
- **AIR VALVE AND REGULATOR NEEDS:** Double check to make sure that all air regulators and solenoid valves are sufficiently sized to run the White Knight pump that you are installing.

WARNING

- ◆ **DO NOT LIFT PUMP BY SHUTTLE VALVE ASSEMBLY!**

Damage may occur to mounting system.

- ◆ Required air flow for the AT/AP50 pneumatic shuttle is 3/16" minimum orifice unrestricted. Required air flow for the AT/AP100 pneumatic shuttle is 1/4" minimum orifice unrestricted. Required air flow for the PL60 pneumatic shuttle is 1/4" minimum orifice unrestricted. Required air flow for the AP200 pneumatic shuttle is 1/4" minimum orifice unrestricted. Required air flow for the AT/AP300 pneumatic shuttle is 3/8" minimum orifice unrestricted. Required air flow for the PL120 pneumatic shuttle is 3/8" minimum orifice unrestricted.
- ◆ Required air flow for the AP50FM pneumatic shuttle is 3/16" minimum orifice unrestricted. Required air flow for the AP100FM pneumatic shuttle is 1/4" minimum orifice unrestricted. Required air flow for the AP200FM pneumatic shuttle is 1/4" minimum orifice unrestricted. Required air flow for the AP300FM pneumatic shuttle is 3/8" minimum orifice unrestricted.
- ◆ Required air flow for the AT/AP25EXT2 pneumatic shuttle is 3/16" minimum orifice unrestricted. Required air flow for the AT/AP50EXT2 pneumatic shuttle is 1/4" minimum orifice unrestricted. Required air flow for the AP100EXT2 pneumatic shuttle is 1/4" minimum orifice unrestricted. Required air flow for the AT/AP100EXT3 pneumatic shuttle is 3/8" minimum orifice unrestricted.
- ◆ Required air flow for the AP25FMEXT2 pneumatic shuttle is 3/16" minimum orifice unrestricted. Required air flow for the AP50FMEXT2 pneumatic shuttle is 1/4" minimum orifice unrestricted. Required air flow for the AP100FMEXT2 pneumatic shuttle is 1/4" minimum orifice unrestricted. Required air flow for the AP100FMEXT3 pneumatic shuttle is 3/8" minimum orifice unrestricted.
- ◆ Do not operate any White Knight® pumps above the "air supply/fluid temperature limitations" (see chart for specifications) or 60psi static in ambient applications on all versions of AP and AT series pumps.
- ◆ Minimum operating pressure is 20psi.
- ◆ Tubing connectors supplied by White Knight must be used on the inlet and outlet ports of the pump. **THESE PORTS ARE NOT NPT OR ANY OTHER STANDARD.** Attempting to use connectors other than ones supplied by White Knight will damage the pump. Such damage is not covered under warranty. Many styles of connection are available. If your pump does not have the style of connector that you desire, please contact White Knight for other options.
- ◆ **BE FAMILIAR WITH WHITE KNIGHT® PUMP INSTALLATION INSTRUCTIONS.** White Knight® pump installation requirements may vary from requirements of other pneumatic pumps.

If you are in need of any of the above mentioned literature please contact us by one of the following:

Toll free: 888.796.2476 Phone : 435.783.6040

Fax : 435.783.6128

E-mail : customer.support@wkfluidhandling.com

Web site : wkfluidhandling.com

Renaissance Series Pump Exploded View

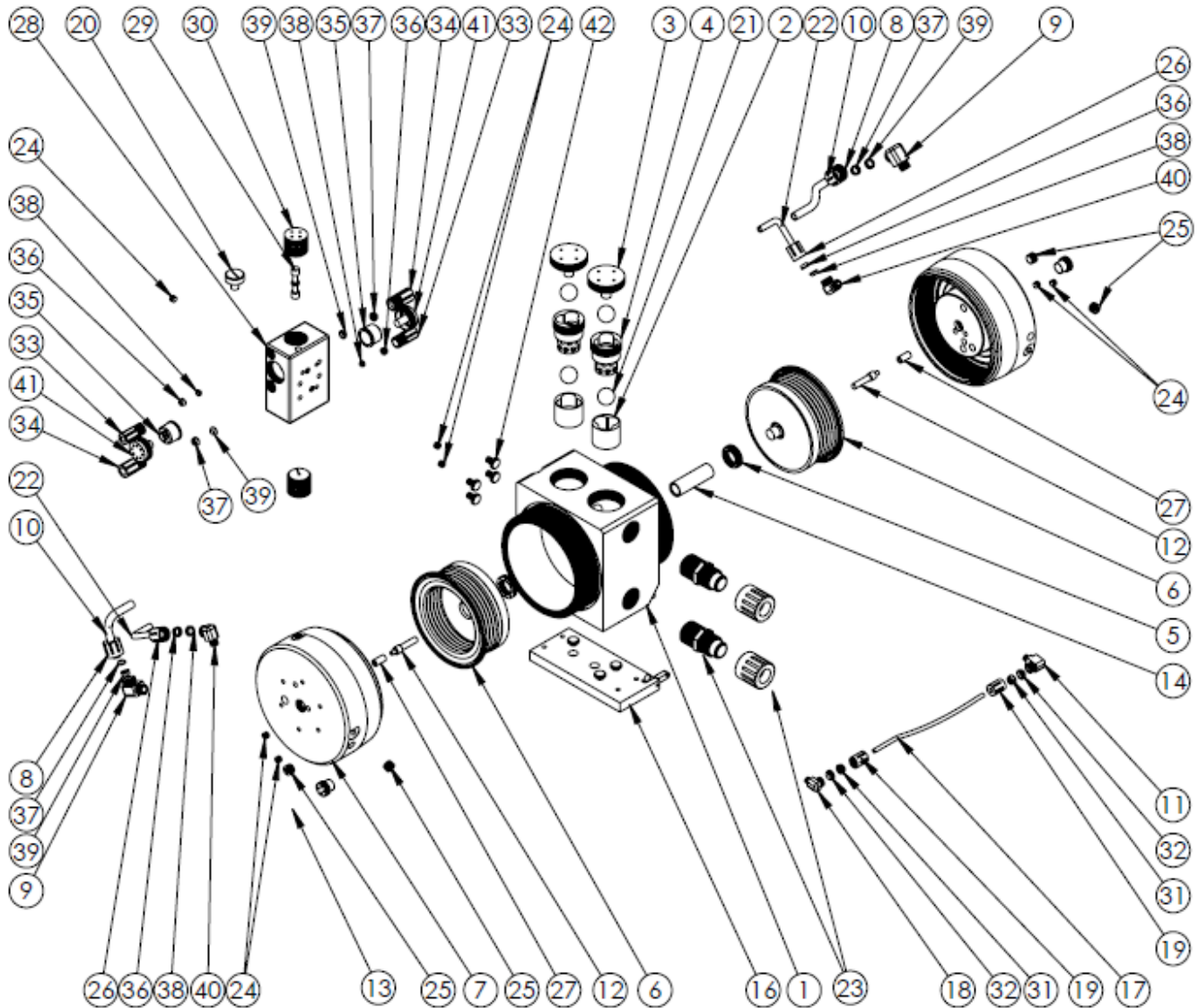

PL120 Bill of Materials

ITEM NO.	PART NUMBER	DESCRIPTION	QTY.	ITEM NO.	PART NUMBER	DESCRIPTION	QTY.
1	1125-TE-0012	Pump Body	1	23	14510-TE-0007	Flaretek® Compatible Assembly	2
2	4135-TE-0010	Bottom Check Seat	2	24	10040-TE-0002	NPT Plug - 1/8"	7
3	4140-TE-0004	Top Check Plug	2	25	10040-TE-0004	NPT Plug - 3/8"	5
4	4142-TE-0005	Top Check Seat	2	26	6070-NP-0002	Female Gripper Nut - 3/8"	2
5	5143-TE-0002	Shaft Seal	2	27	10060-TE-0002	Shift Piston Bushing	2
6	3130-MP-0014	Bellows	2	28	14400-NP-0003	Shuttle Body Assembly	1
7	2127-EP-0001	Pump Head	2	29	6560-CE-0003	Shuttle Spool	1
8	6070-NP-0003	Female Gripper Nut-1/2"	2	30	6530-TE-0003	Shuttle End Cap	2
9	6020-NP-0004	3/8" NPT X 1/2" Gripper Elbow	2	31	6080-KF-0001	Gripper-1/4"	2
10	10070-PF-0004	PFA Tubing-1/2"	2	32	6080-TE-0001	Ferrule - 1/4"	2
11	6040-NP-0001	1/8" NPT X 1/4" Gripper X 1/8" FNPT	1	33	6070-NP-0006	Male Gripper Nut-3/8"	2
12	2128-CE-0002	Shift Piston	2	34	6070-NP-0007	Male Gripper Nut-1/2"	2
13	8100-PF-0005	Stroke Detect End Cap	2	35	6140-TE-0003	Whisper® Muffler	2
14	5144-PF-0004	Shaft	1	36	6080-KF-0002	Gripper - 3/8"	4
15	6110-PP-0003	Polypro Muffler Port Size 1/8"	1	37	6080-KF-0003	Gripper - 1/2"	4
16	14200-NP-0004	Base Plate Assembly	1	38	6080-TE-0002	Ferrule - 3/8"	4
17	10070-PF-0002	Thin-wall Tubing-1/4"	1	39	6080-TE-0003	Ferrule - 1/2"	4
18	6030-NP-0001	1/8" NPT X 1/4" Gripper Elbow	2	40	6020-NP-0001	1/4" NPT X 3/8" Gripper Elbow	2
19	6070-NP-0001	Female Gripper Nut-1/4"	2	41	6150-TE-0003	Whisper® Muffler Cap	2
20	10010-NP-0005	Shuttle Set Screw	1	42	10100-NP-0001	Mounting Screw	4
21	4100-TE-0004	Check Ball	4				
22	10070-PF-0003	PFA Tubing-3/8"	1				

PL 120 Installation Instructions

**WARNING: DO NOT LIFT PUMP OUT OF THE BOX BY THE TUBING.
THIS COULD CAUSE SERIOUS DAMAGE TO THE FITTINGS.**

- ◆ The PL120 base plate is designed to be mounted with two 3/8" or two 10mm socket head cap screws spaced 2.000" apart.
- ◆ Remove the base plate from the pump by lifting the lever lock base plate lever (10) and sliding the pump (1) forward then lifting it off of the base mount knobs (11) on the base plate (9).
- ◆ Install base plate (9) into work station by tightening it down with two 3/8" or two 10mm socket head cap screws, screwed into previously drilled and tapped mating holes at a 2" hole distance.
- ◆ Place the pump assembly (1) onto the mating base mount knobs (11) of the base plate (9) the lever (10) lifts up automatically. Slide the pump assembly (1) back and the lever (10) drops to hold the pump in place.
- ◆ Affix PFA thick wall tubing to fluid connectors without wrenches, hand tighten only. Installation of lines is: intake on bottom; discharge on top. If pump is equipped with Synchro flare fittings, use standard flaring procedures.
- ◆ Hook up 3/8" NPT fitting attaching a minimum of 1/2" PFA tubing to the space saver elbow (18) located on the back of the shuttle body (33). Air supply must be 3/8" minimum orifice (3/8" unrestricted air flow) back to supply source.
- ◆ If Leak or Stroke detect options have been selected for pump see below pictures for hook up instructions.
- ◆ Minimum operating pressure of 20psi. Maximum operating pressure of 80psi. Check temperature to air supply charts for exact maximum allowable air supply pressure.

CAUTION: AIR SUPPLY MUST BE 3/8" MINIMUM ORIFICE (3/8" UNRESTRICTED AIR FLOW) FROM SUPPLY SOURCE TO PUMP.

NOTICE: WHEN OPERATING A RENAISSANCE PUMP WITH A WHITE KNIGHT SHUTTLE VALVE IN CONJUNCTION WITH A PULSE DAMPENING DEVICE THE AIR SUPPLY PRESSURE (TO THE PUMP) SHOULD BE AT LEAST 10PSI OVER THE LIQUID LINE PRESSURE. FAILURE TO DO SO CAN CAUSE THE PUMP TO RUN ERRATICALLY.

**Problems or Questions, call toll free:
888.796.2476
Or 435.783.6040**

PL 120 (Dual Slave Heads) Installation Instructions

**WARNING: DO NOT LIFT PUMP OUT OF THE BOX BY THE TUBING.
THIS COULD CAUSE SERIOUS DAMAGE TO THE FITTINGS.**

- ◆ The PL120 base plate is designed to be mounted with two 3/8" or two 10mm socket head cap screws spaced 2.000" apart.
- ◆ Remove the base plate from the pump by lifting the lever lock base plate lever and sliding the pump (1) forward then lifting it off of the base mount knobs on the base plate (16).
- ◆ Install base plate (16) into work station by tightening it down with two 3/8" or two 10mm socket head cap screws, screwed into previously drilled and tapped mating holes at a 2" hole distance.
- ◆ Place the pump assembly (1) onto the mating base mount knobs of the base plate (16) the lever lifts up automatically. Slide the pump assembly (1) back and the lever drops to hold the pump in place.
- ◆ Affix PFA thick wall tubing to fluid connectors without wrenches, hand tighten only. Installation of lines is: intake on bottom; discharge on top. If pump is equipped with Synchro flare fittings, use standard flaring procedures.
- ◆ Install 2 each 1/8" NPT mufflers to the sides of the pump heads (face of pump heads). See picture below for details.
- ◆ Hook up 2 each 3/8" NPT fittings attaching a minimum of 1/2" PFA tubing to each of the two 3/8" NPT ports located either on the face of the pump heads or on the radius of the pump heads. See picture below for details. Air supply must be 3/8" minimum orifice (3/8" unrestricted air flow) back to supply source.
- ◆ If Leak or Stroke detect options have been selected for pump see below pictures for hook up instructions.
- ◆ Minimum operating pressure of 20psi. Maximum operating pressure of 80psi. Check temperature to air supply charts for exact maximum allowable air supply pressure.

CAUTION: AIR SUPPLY MUST BE 3/8" MINIMUM ORIFICE (3/8" UNRESTRICTED AIR FLOW) FROM SUPPLY SOURCE TO PUMP.

NOTICE: WHEN OPERATING A RENAISSANCE PUMP WITH A WHITE KNIGHT SHUTTLE VALVE IN CONJUNCTION WITH A PULSE DAMPENING DEVICE THE AIR SUPPLY PRESSURE (TO THE PUMP) SHOULD BE AT LEAST 10PSI OVER THE LIQUID LINE PRESSURE. FAILURE TO DO SO CAN CAUSE THE PUMP TO RUN ERRATICALLY.

NOTICE: WHEN OPERATING A RENAISSANCE PUMP IN TIMER/OSCILATOR MODE THE PUMP SHOULD RUN AT A SPEED FAST ENOUGH TO KEEP THE BELLOWS FROM REACHING THE END OF THE STROKE. THIS IS BECAUSE ONCE THE BELLOWS HAS REACHED THE END OF STROKE THE BELLOWS WILL BALOON AND FATIGUE. A GOOD WAY TO DETERMINE THE CYCLE RATE IS TO TAKE THE FLOW RATE AND DIVIDE IT BY THE PUMP DISPLACEMENT AND MULTIPLY IT BY 1.25. FOR EXAMPLE PUMP FLOW RATE IS 20GPM, THE DISPLACEMENT PER CYCLE FOR THE PL120 IS .250 GPM. THE CYCLE RATE WOULD THEN BE $20 / .250 = 80$ X 1.25 = 100. IF LARGE AMOUNTS OF EXHAUST ARE COMING OUT THE SHIFT EXHAUST MUFFLERS THE SPEED SHOULD BE INCREASED. ONLY A SMALL AMOUNT OF EXHAUST SHOULD ESCAPE OUT.

PL120 Hook-Up Connections

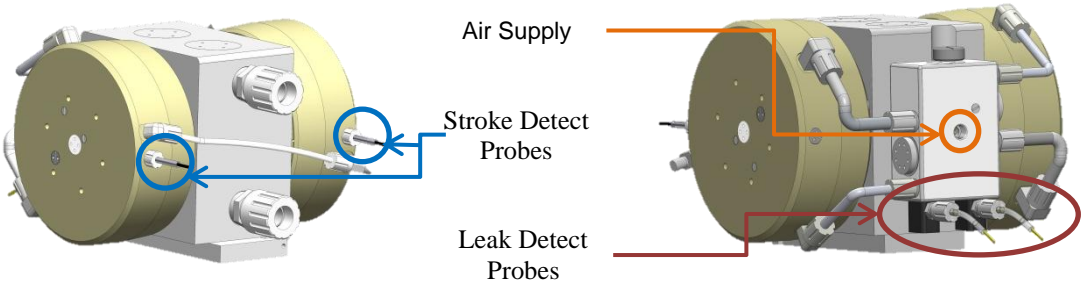

PL120 Dual Slave Head Hook-Up Connections

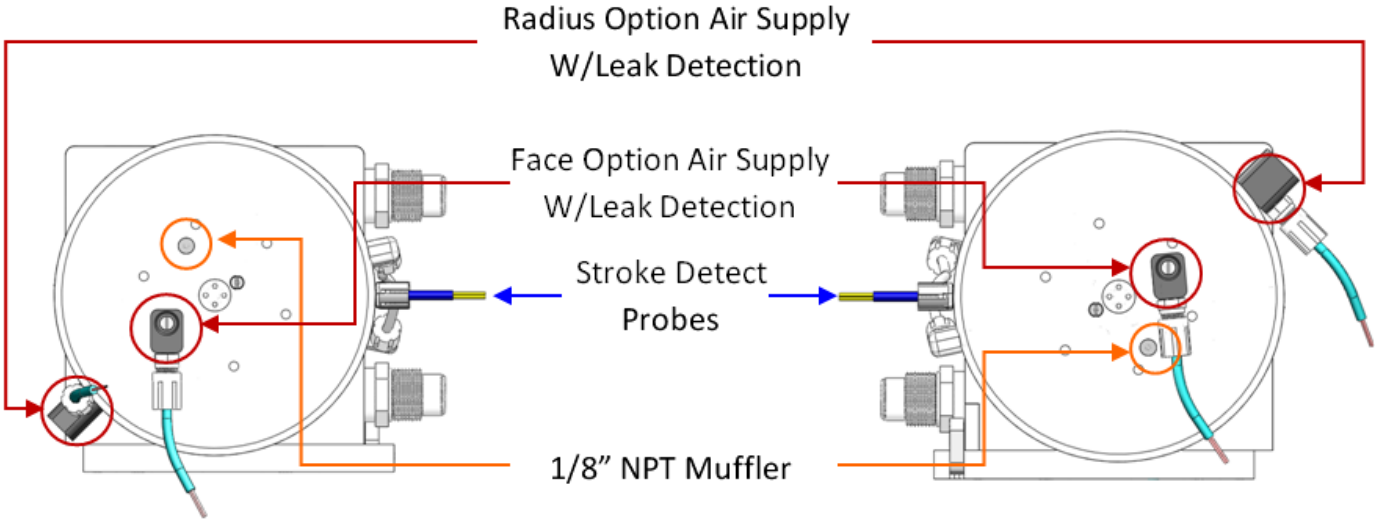

Renaissance PL120

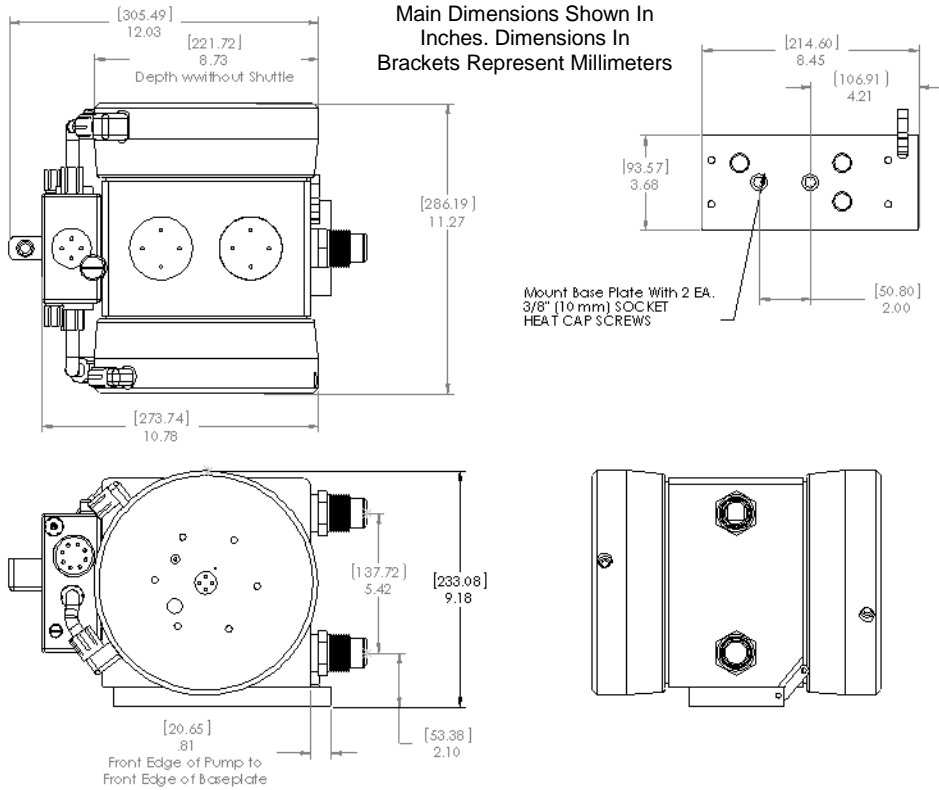

PL120 Head Pressure Line Chart

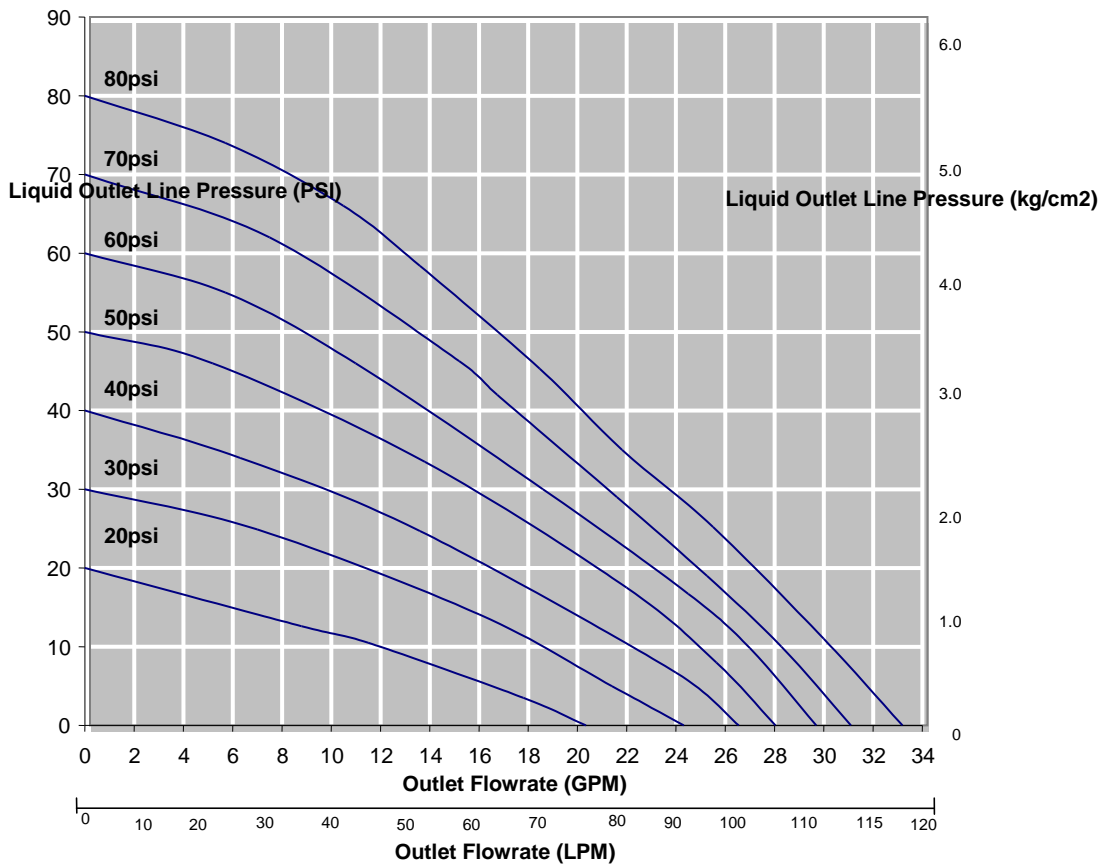

Renaissance PL120

PL120 Air Consumption Line Chart

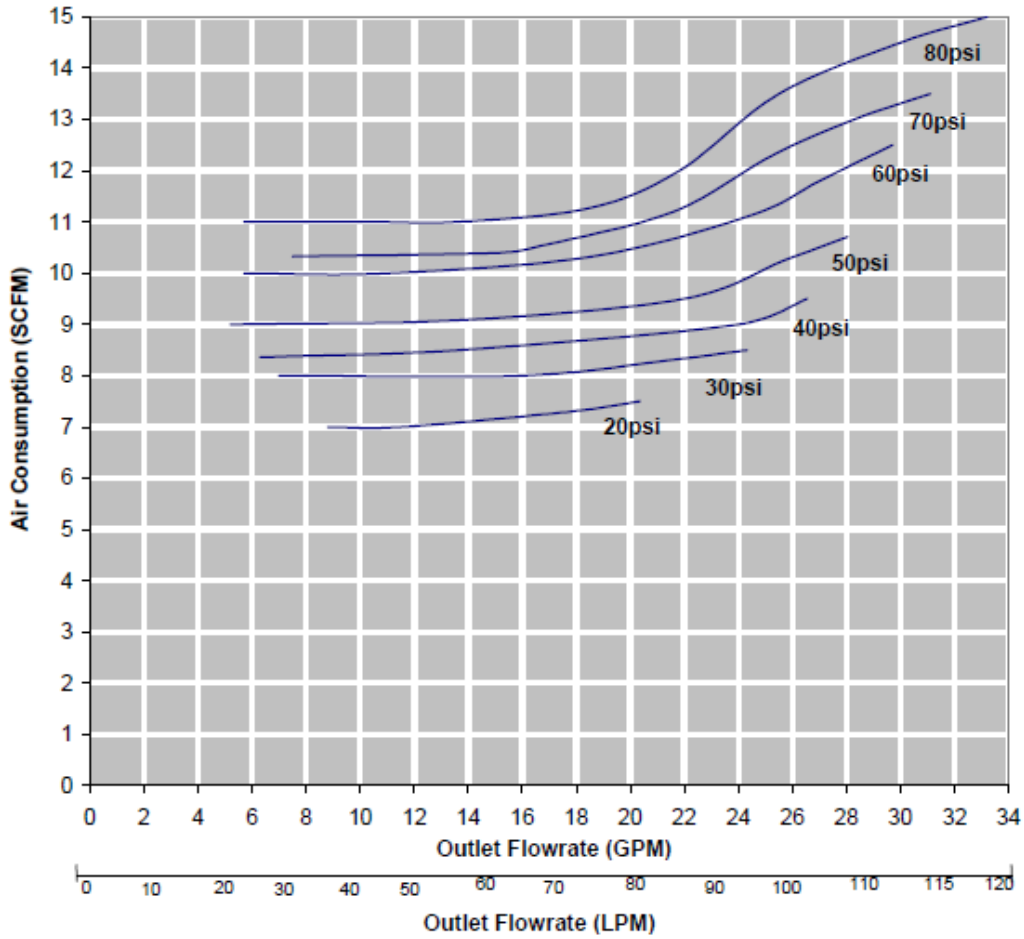

Renaissance PL120 Air Supply/Fluid Temperature Limitations

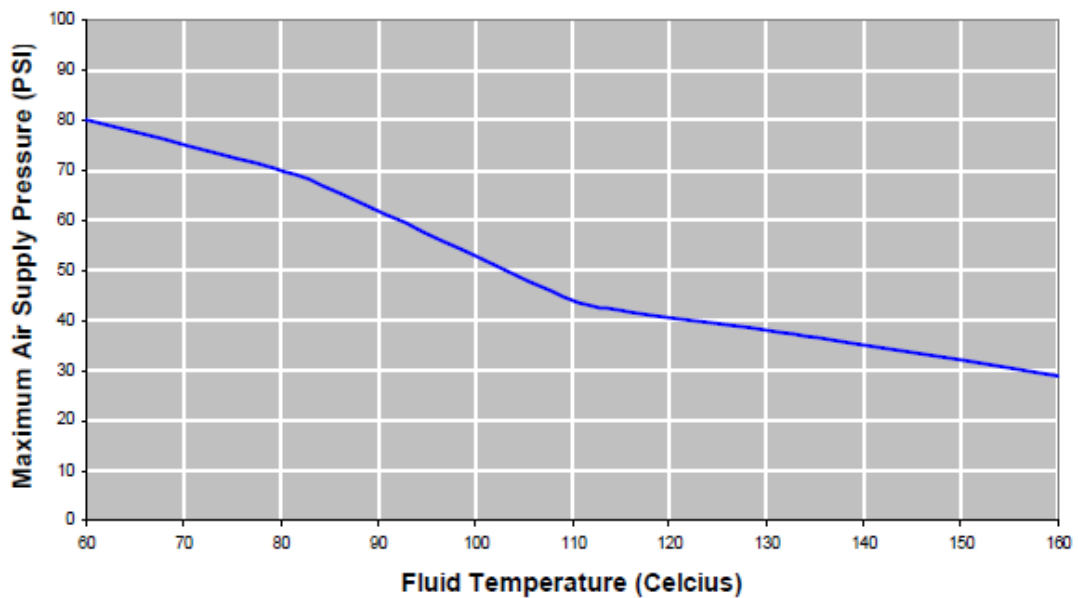

Rebuild Information

While an exploded view of this pump is contained within this owner's manual, we felt that including rebuild instructions herein would be insufficient with the other instruments that we have made available. White Knight has provided Virtual Rebuild instructions on our web site where written technical instructions are accompanied by a virtual pump. After reading each technical instruction the reader can click on the instruction and watch the operation performed with a virtual tool on the virtual pump. Please visit our web site at wkfluidhandling.com for a free download of Virtual Rebuild.

Failed or problematic pumps under warranty must be returned to White Knight for warranty coverage. With pumps that are out of warranty White Knight offers four options.

1. Our best recommendation is to return the pump to us at White Knight where the pump will be fully evaluated and you will receive a written quote on rebuilding the pump through our local distributor. If the quotation is accepted and a purchase order granted, the pump will be fully rebuilt and will receive a new warranty (parts and labor) equal to what the pump had when it was new. At White Knight our technicians have more experience rebuilding our pumps than anywhere else in the world. Their vast experience and expertise ensure that the pump will be running at its best when it is reinstalled into the system.
2. Another option that White Knight offers is to train technicians of companies who own White Knight pumps at no charge to maintain and rebuild White Knight pumps. While there is no charge for the two days of training, companies participating in this program are responsible for their own travel and expenses. Persons successfully completing the training course will be given a certificate that certifies them on whichever pumps they are trained to rebuild for two years. White Knight will warranty parts in pumps rebuilt by White Knight certified technicians for the same amount of time that White Knight would have warranted the pump were it rebuilt at White Knight.
3. The third option is made available to companies who are concerned about shipping of pumps back and forth. White Knight has trained a number of third party companies to rebuild pumps. If you are concerned about shipping pumps back and forth to White Knight for rebuilding, please contact us at White Knight to see if there is a certified third party rebuilder in your area.
4. The last option is for you to purchase rebuild kits through your local White Knight distributor (a list of local distributors can be found on our web site at wkfluidhandling.com) and rebuild the pumps on your own without training, though we discourage this practice. But, if this is what you decide to do, please at least download a copy of Virtual Rebuild instructions from our web site.

Trouble Shooting

From time to time we learn of new things to assist in troubleshooting pumps and the systems they run in. Because of this our troubleshooting guide changes from time to time. For an updated version of our troubleshooting guide, please visit our web site at wkfluidhandling.com

Before Returning a Pump to White Knight an RMA From White Knight is Required. At the end of this manual is a Decontamination Certificate which will need to be filled out and sent back to White Knight. Once this form is received an RMA # will then be issued along with pump return instructions. Requests for RMA#'s may be sent to customer.support@wkfluidhandling.com or faxed to 435.783.6128.

The Following Decontamination and Shipping Instructions Must be Followed.

White Knight Product Decontamination Instructions

Attention:

White Knight products are designed for use with caustic and otherwise dangerous liquids. Therefore, every product must be handled as if it contains dangerous chemicals whether or not it actually does. White Knight specifies that if a pump runs under its own power that the pump should circulate DI water for twenty minutes before disassembly or double bagging for shipment. If the pump does not run under its own power, then DI water should be forced from the inlet, through the outlet for 40 minutes before disassembly or double bagging for shipment. Only those who have been adequately trained in safety with and the handling of acids and other dangerous chemicals should attempt to handle a White Knight pump that has been used. Adequate safety gear appropriate for the chemical that has been in the pump must be used/worn and no attempt should be made to handle the pump until Material Safety Data Sheets (here after MSDS) for the chemical that the pump has been used in have been reviewed. Ph Papers, Showers, antidotes, clean-up equipment, neutralizers, and any other safety devices that could be used for detecting, neutralizing or minimizing effects from the chemical described in the appropriate MSDS must be present as well as emergency numbers for use in the event of an accident. Take great care in the handling of liquids and/or residues contained in these pumps or any other chemical handling equipment. Remember, **Safety First**.

Note:

Any pumps returned to White Knight for warranty evaluation or repair must be complete with all parts and components including but not limited to base plates, mount screws, tubing connectors, tubing connector caps, flare noses, shuttle valves, mufflers, and tubing. Any missing parts will be added to the pump and charged to the customer in the event of repair or replacement, warranty or otherwise.

Removal of Pump From Station:

1. Disconnect liquid tubing connectors from the front (opposite the externally mounted shuttle valve) of the pump.
2. Plug npt fittings with PTFE plug, Flare fittings with flare nose cover and cap, or other plug or cap as recommended by connector supplier.
3. Disconnect air supply tubing from face of shuttle valve.
4. Loosen mount screw (#20) from Base Plate (#18) using thumb and forefinger but do not completely remove the screw from the base plate.
5. If another White Knight pump of the same model number is to go into the same application the base plates are interchangeable and the base plate in the station would not need to be removed. Otherwise, the base plate should be removed using the proper tool for the fastening devices (not provided by White Knight) used. (usually allen wrenches or flat head screw driver).
6. Return all removed parts to the pump.

Return of Pump to White Knight:

1. After removing the pump from the station the pump must be flushed as described in the attention section of this document.
2. Remaining DI water in the pump should be drained from the inlet and outlet liquid tubing connectors to the greatest extent possible.
3. The pump liquid outlets must then be plugged as described in the removal of pump from station section of this document on line two.
4. Dry off the pump.
5. Double bag the pump **sealing it** in thick polyethylene bags.
6. Return the pump to its original packaging.
7. Include MSDS for the chemical that the pump was handling in the box with the pump.
8. Obtain RMA number from White Knight and write it on the outside of the box.
9. Ship to White Knight following all rules, regulations and laws regarding the shipping of dangerous materials. Ship freight pre-paid. No collect shipments will be accepted. Unauthorized use of White Knight shipping accounts will result in the adding of freight to the bill in addition to a service charge.



**WHITE
KNIGHT™**

187 E. 670 S. • Kamas, UT 84036
 Phone 435.783.6040 • Fax 435.783.6128
 Toll Free 888.796.2476
wkfluidhandling.com

Ordering Instructions Renaissance PL120

White Knight Pumps have many options and configurations to make them as versatile as possible for our customers. With this versatility comes the trouble of a part numbering system that makes it reasonably easy to order pumps, retrieve part numbers and recognize the numbers as pumps are in the field. For this reason, we have devised the following part numbering system.

All White Knight pump part numbers will begin with the model number (in this case PL120). The prefix will then be followed by a series of letters. Each letter will designate the configuration of a certain part of the pump.

The following is a list of those areas, their options, and the letter specifying the specific option. Choose an option for each of the 8 spaces and add the appropriate value to the Pump List Price. The standard dash letters are in large bold type.

PL120- _____ - _____
 (Last Four Letters are Optional)

Area:	Option:	Letter:
Liquid Inlet Configuration (first letter of suffix)	Front, Straight Front, Ell	A B
Liquid Outlet Configuration (second letter)	Front, Straight Front, Ell Top, Straight Top, Ell	A B C D
Liquid Inlet Connection Style (third letter)	1" Synchro-Flare® 3/4" Synchro-Flare® 1" fnpt 1-1/4" fnpt 3/4" fnpt 1" Kurabo Finalock®*	A B C D E H

3/4" Kurabo Finalock®*	I
1" Tubing Out	J
3/4" Tubing Out	K
Blank	L

(This is not an NPT or any other standard. A fitting provided by White Knight Fluid Handling, INC is required in order to make any connection to the pump)

3/4" Flaretek® Compatible	M
1" Flaretek® Compatible	N
3/4" PureBond®	O
1" PureBond®	P
1" Pillar Super 300®	Q
3/4" Pillar Super 300®	R
1 1/4" Tubing Out	S
1 1/4" Flaretek® Compatible	T
1 1/4" Pillar Super 300®	U

*These options require the appropriate nut and ferrule and are NOT supplied by White Knight Fluid Handling, INC.

Liquid Outlet Connection Style (fourth letter)	1" Synchro-Flare®	A
	3/4" Synchro-Flare®	B
	1" fnpt	C
	1-1/4" fnpt	D
	3/4" fnpt	E
	1" Kurabo Finalock®*	H
	3/4" Kurabo Finalock®*	I
	1" Tubing Out	J
	3/4" Tubing Out	K
	Blank	L

(This is not an NPT or any other standard. A fitting provided by White Knight Fluid Handling, INC is required in order to make any connection to the pump)

3/4" Flaretek® Compatible	M
1" Flaretek® Compatible	N
3/4" PureBond®	O
1" PureBond®	P
1" Pillar Super 300®	Q
3/4" Pillar Super 300®	R
1 1/4" Tubing Out	S
1 1/4" Flaretek® Compatible	T
1 1/4" Pillar Super 300®	U

*These options require the appropriate nut and ferrule and are NOT supplied by White Knight Fluid Handling, INC.

Note: The following items are optional. However if ANY ONE item is selected, ALL must be included in the part order number. For example, if Leak Detection is desired but not Stroke Detection, then Stroke Detection must be noted as option "A". If none are required then the part

order number may be submitted without any of these letters.

Shuttle Valve Type (fifth letter optional)	No Shuttle Valve	A
	With External Shuttle Valve	B

Pulse Dampener (sixth letter optional)	No Pulse Dampener	A
--	--------------------------	----------

Stroke Detection (seventh letter optional)	No Stroke Detection	A
	Single Fiber Optic Probe (PNP) Sourcing	B
	Single Fiber Optic Probe (NPN) Sinking	C
	Single Fiber Optic Probe (No sensors)	D
	Dual Fiber Optic Probe (PNP) Sourcing ¹	E
	Dual Fiber Optic Probe (NPN) Sinking ¹	F
	Dual Fiber Optic Probe (No sensors) ¹	G
	Solid State Pressure Switch	H
	Single Probe Dual Detect (PNP) Sourcing	I
	Single Probe Dual Detect (NPN) Sinking	J
	Single Probe Dual Detect (No sensors)	K
	Single Probe Dual Detect (No probe/sensors)	L
	Fiber Optic Stroke Detect caps only (No probe/sensors)	M
	Dual Solid State Pressure Switch ¹	N

¹(Dual Fiber Optic Probes and pressure switches are not available with Internal Shuttle Option, see fifth letter)

Leak Detection (eighth letter optional)	No Leak Detection	A
	Fiber Optic (PNP) Sourcing	B
	Fiber Optic (NPN) Sinking	C
	Fiber Optic (No sensors)	D
	Conductivity ¹	E

¹(Should not be used for explosion proof environment)

Old rev level (ninth letter optional)	Specify rev level	A
---	-------------------	---

(This option is added for customers requiring Copy Exact due to their ISO specifications. Pumps ordered without the eighth letter will be shipped the latest revision)

Order Notes

For example, a PL120 with straight front inlet, Top Straight outlet, 1"Flaretek Compatible inlet, 3/4" Flaretek Compatible inlet, External Shuttle Valve, no Pulse Dampener, no stroke Detection, and no Leak Detection, would be ordered as follows: PL120-ACNMBAAA.

Standard for White Knight PL120 is inlet straight front, outlet straight front, inlet 1" Flaretek® Compatible, outlet 1" Flaretek® Compatible, No Shuttle, no Pulsation Dampener, no Leak Detection, and no Stroke Detection. A PL100 ordered with no suffix lettering would be delivered to the standard configuration (PL120-AANNAAAA).



WHITE KNIGHT™

187 E. 670 S. • Kamas, UT 84036
 Phone 435.783.6040 • Fax 435.783.6128
 Toll Free 888.796.2476
wkfluidhandling.com

Rebuild Parts For PL120 Series Pumps						
				Part Name	Part Number	Req. Quantity
****	***	**	*	Bellows Shift Assembly	3130-MP-0014	2
****			*	1 1/8" Check Ball	4100-TE-0004	4
****			*	Check Cage Bottom	4135-TE-0010	2
****			*	Check Cage Top	4142-TE-0005	2
****	***	**	*	Shaft	5144-PF-0004	1
****	***	**	*	Shaft Seal	5143-TE-0002	2
		**	*	Shuttle End Cap	6430-TE-0003	2
		**	*	Whisper Muffler Insert	6140-TE-0003	2
				Labor	PLRB120-50	1
Rebuild Kits For PL120 Series Pumps						
				Kit Name	Part Number	
			*	Rebuild Kit w/ Checks	RBPL120-1	
			**	Rebuild Kit	RBPL120-2	
			***	Rebuild Kit Dual Slave Head	RBPL120-3	
			****	Rebuild Kit Dual Slave Head w/ Checks	RBPL120-4	
				PL120 Tool Kit	PL120-170	

- * Items in RBPL120-1
- ** Items in RBPL120-2
- *** Items in RBPL120-3
- **** Items in RBPL120-4

A PL120 Tool Kit is required to perform rebuilds on PL120 pumps.

Pumps rebuilt by White Knight Fluid Handling, Inc. or other authorized company receive a full 2-year warranty.

White Knight

FLUID HANDLING, INC.

PUMP WARRANTY

White Knight Fluid Handling, Inc. follows strict procedures in all phases of manufacturing, assembly and testing to ensure reliability of its products. Each pump is individually tested to assure its functional operation integrity.

White Knight Fluid Handling, Inc. warrants pumps, subassemblies and components to be free from defects in materials and workmanship for the period of one year from the date of start-up or 18 months from the date of shipment, whichever applies. Failures due to misuse, abuse or any unauthorized disassembly of a **White Knight® pump** could nullify this warranty.

Some pumps carry additional warranty coverage, for instance, Renaissance Series pumps carry two year warranties and EXT Series pumps carry two or three year warranties depending on the version of pump.

The Renaissance™ Series PL120 pumps are warranted for up to 80psi air supply pressure, are not covered under dry run conditions, and are not covered in the event of running abrasive slurries.

All variations of AP, AT, and APFM as well as EXT models are only covered up to 60psi of air supply pressure, are not covered under dry run conditions, and are not covered in the event of running abrasive slurries.

Due to the broad and ever evolving applications for usage of **White Knight®** pumps we cannot guarantee the suitability of any pump, component, or subassembly for any particular or specific application. **White Knight Fluid Handling, Inc.** shall not be liable for any consequential damage or expense arising from the use or misuse of its products in any application. Responsibility is limited solely to the replacement or repair of defective **White Knight®** pumps, components, or subassemblies. All options to rebuild or replace aforementioned items shall remain under the judgment of **White Knight Fluid Handling, Inc.** Decisions as to the cause of failure shall be solely determined by **White Knight Fluid Handling, Inc.**

Prior written, faxed, or emailed approval must be obtained from **White Knight Fluid Handling, Inc.** before returning any pump, component, or subassembly for warranty consideration.

The foregoing warranty is exclusive and in lieu of all other warranties expressed or implied including any warranties of suitability for any particular purpose. No variations of this warranty by anyone other than the president of **White Knight Fluid Handling Inc.** in a self signed agreement shall be honored or considered legal binding.

John Simmons, President
White Knight Fluid Handling, Inc.

Flatliner™ Pulsation Dampeners

By White Knight

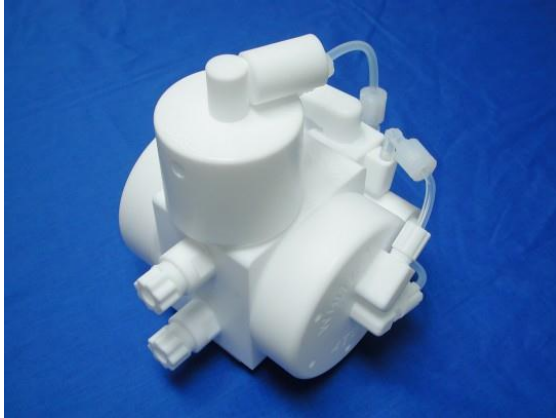

Did You Say That You Wanted A Pulsation Dampener With Only One Moving Part?

- Mount in line with any pump.
- Top of pump mounting available on AT Series Pumps.
- Reduces line pulsation to as low as plus or minus ½ PSI*
- 100% PTFE Construction.
- Temperatures to 200° Celsius.
- **Only One Moving Part.**

*Line pressure delta varies in relation to head pressure in line.

Flatliner™ Pulsation Dampeners By White Knight

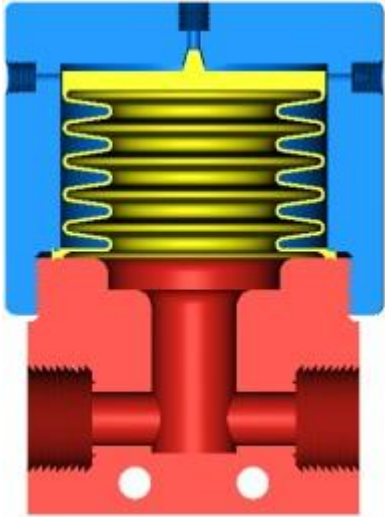

During stroke of the pump liquid pressure overrides air pressure and fills bellows with liquid.

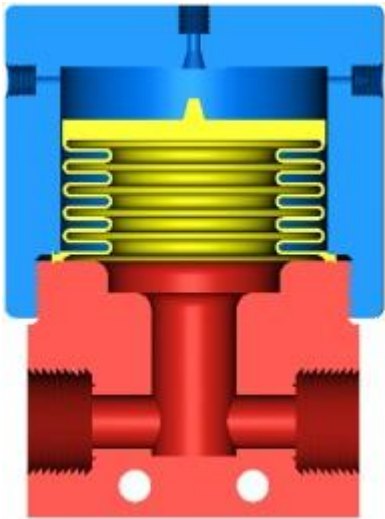

During shift of the pump air pressure overrides liquid pressure and moves liquid from bellows to outlet line to reduce line pressure delta.

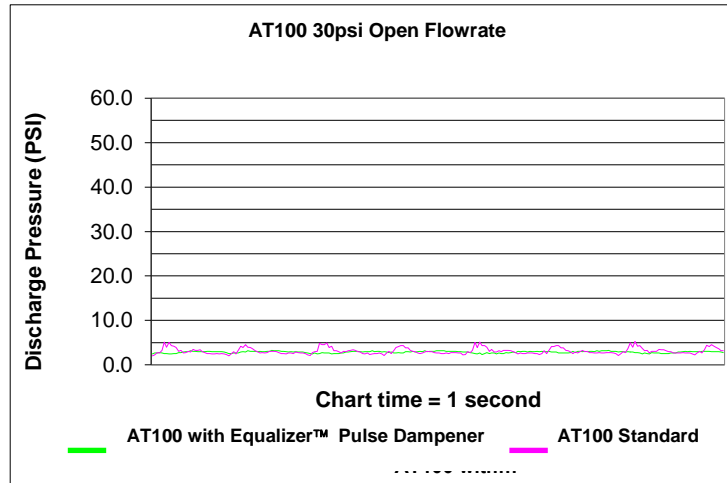

AT100 with 30PSI supply, unrestricted flow

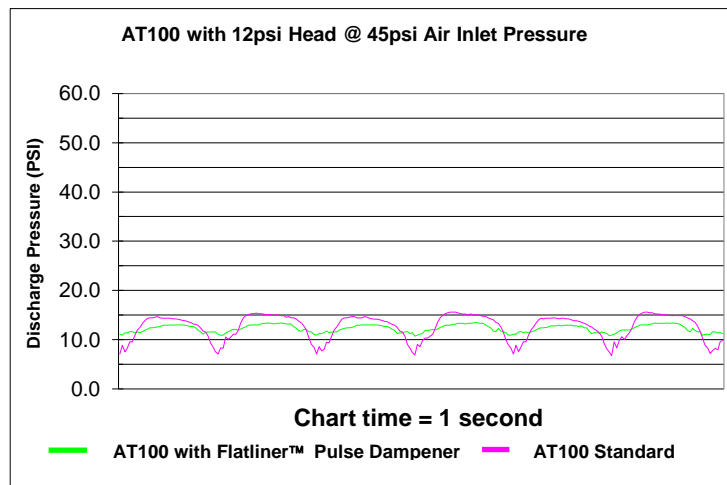

AT100 with 12PSI of head pressure



**WHITE
KNIGHT™**

Surgeless™ Pulsation Dampeners

By White Knight

SL100

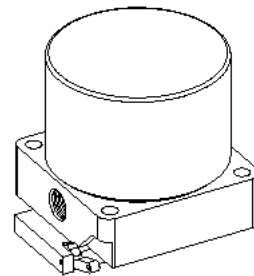
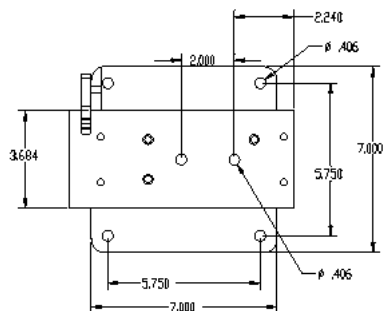
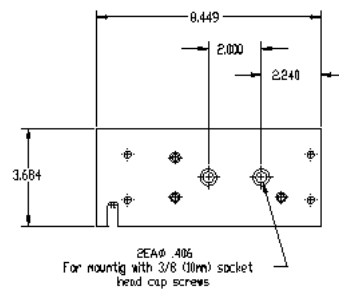
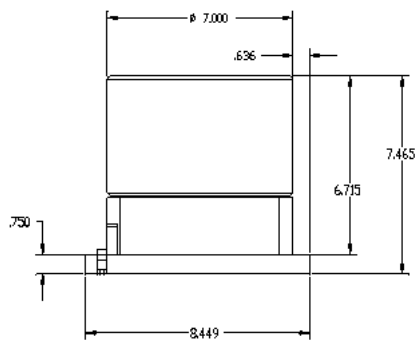

Surgeless™ Pulsation Dampeners

By White Knight

Did You Say That You Wanted a Passive Pulsation Dampener That is as Effective as an Air Operated Dampener?

- Mount in line with any pump.
- Reduces line pulsation to as low as plus or minus ½ PSI*
- 100% PTFE Construction.
- Two Year Warranty.
- Only One Moving Part.

**PL60
Operating
at 70PSI
with 40PSI
Liquid
Line
Pressure**

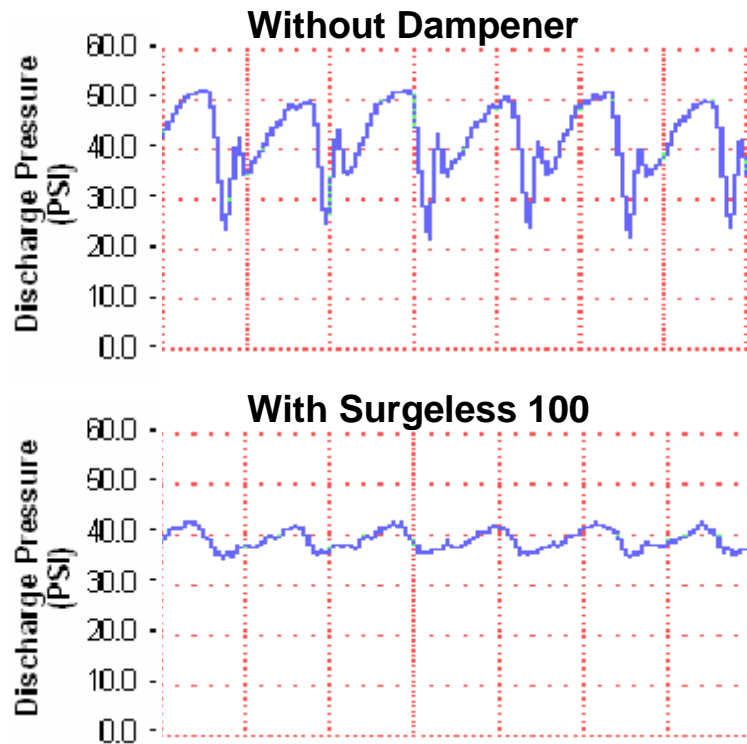

*Line pressure delta varies in relation to head pressure in

Pump Accessories By White Knight



Merlin™ pump translator. Converts input from stroke detection to output of different fractional rate to allow for drop in replacement of other monitored pumps of different displacements.

Merlin™ pump controller. Provides programming of pump for times on and off as well as multiple programmable flow rates based on displacement and air pressure.

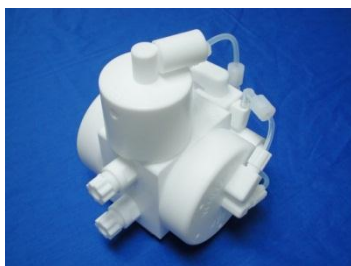

Pulse Dampeners. Pulse dampeners come preset from White Knight for the best all around pulse dampening, but additional bleed orifices are included so that a pulse dampener can be fine tuned for maximum performance to a specific pump supply pressure to back pressure

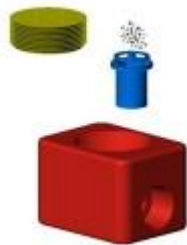
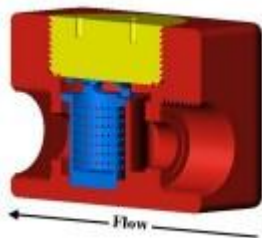

Catcher™ Pump inlet screen. To protect pump from harmful solids such as wafer shards. Larger through holes than many pre pump filters to avoid loading of filter by fine crystals often found in chemistries while still filtering out the majority of solids that could damage the pump. Screen can be removed and cleaned without disconnection of liquid inlet and outlet lines. If a White Knight pump is damaged from passing a solid while using the Catcher™, White Knight will repair the pump at no charge to the customer.



Whisper™ Porous PTFE muffler inserts. Provide all the chemical compatibility of PTFE baffles while providing the noise reduction typical of material type mufflers.





Bubble In – Bubble Out™ Fiber optic leak detection. Monitors inlet line for bubbles and outlet line for bubbles. If both have bubbles (as in priming or if chemistry is boiling) the monitor does not react. If there are no bubbles in the inlet line, but bubbles are present in the outlet line, a leak is assumed and alarm is sent.

Fiber Optic air side leak detection. Watches for liquid in the air side of the pump and sends alarm when sighted.



Fiber optic stroke detection. Watches for reciprocating portion of pumps to come in proximity of fiber optic and sends signal. Communicates to Merlin™ products, PLC, etc.

Solid State pressure switch stroke detection. Translates puff of air sent to pump muffler on exhaust into electronic signal for monitoring of pump. Communicates to Merlin™ products, PLC, etc.



Hardware and software for programming Merlin™ pump translator from laptop or PC.



**WHITE
KNIGHT™**



WHITE KNIGHT™

RMA#:

Decontamination Certification

I, the undersigned, employee of _____ certify that all decontamination and safety procedures outlined in the White Knight document labeled "White Knight Pump Decontamination Instructions" have been followed for the pump listed below.

Pump Serial Number: _____ Shuttle Serial Number: _____
(If Known)

Please check one of the following:

- 1. The pump has **not** been used in metal processes (I.E. Copper and Bumping Processes).
- 2. The pump has been used in Metal Processes.

2a. The Metal Process that it was used in is _____
(Insert type of process I.E. Copper, Gold, Lead Bumping, Tin Bumping, Aluminum Etch, Other (please describe))

Failure Mode: _____
Specific Failure Details: _____

Application Parameters: Air Supply: _____ Flow Rate: _____
Process Chemistry: _____ Process Temperature: _____

Duty Cycle: _____ Installation Date (if known): _____

Contact Information to send RMA# and Evaluation Report to: _____ Name: _____

Phone: _____ Email: _____
Customer Reference # (if needed): _____

Pumps that have been exposed to metal processes must be returned to White Knight in packaging or containers which are clearly and conspicuously marked on the outside that the enclosed pump has been exposed to metal processes and to which metal they may have been exposed!

Pumps exposed to Metal Processes must be returned to White Knight via the following address:

White Knight Fluid Handling Inc.
187 East 670 South **Suite B**
Kamas, UT 84036

Pumps **not** exposed to Metal Process must be returned to White Knight via the following address:

White Knight Fluid Handling Inc.
187 East 670 South **Suite C**
Kamas, UT 84036

Name:

Notes

Notes

