



PSA030 Owner's Manual



Table of Contents

1. Product Information	1
1.1 Specifications & Performance	1
1.2 Temperature Limits	2
1.3 Dimensions	2
1.4 Bill of Materials	3
2. Installation	4
2.1 Precautions	4
2.2 Warnings	5
2.3 Advantages	5
2.4 Environment & System	5
2.5 Installation Instructions	6
2.6 Shuttle Service Instructions	7
3. Control & Monitoring	8
3.1 Fiber Optic Stroke Detection Installation	8
3.2 Calibrating D10 Amplifier for Stroke Detection	9
3.3 Single Pressure Switch Stroke Detection Installation	10
3.4 Dual Pressure Switch Stroke Detection Installation	10
3.5 Pressure Switch Stroke Detection Electrical Hookups	11
3.6 Conductivity Leak Detection Installation	12
3.7 Fiber Optic Leak Detection Installation	12
3.8 Calibrating D10 Amplifier for Leak Detection	13
4. Ordering Instructions	14
5. Pump Service	15
5.1 Rebuild Kits & Parts	15
5.2 Return Pump for Service	16
6. Warranty & Accessories	20





Dear valued customer,

Thank you for purchasing a White Knight PSA030 pump.

Our dedicated team designs products to meet your exacting specifications with a demonstrated commitment to quality that goes beyond mere words and fancy slogans.

Our patented designs offer a variety of size and material options to meet stringent requirements of high-pressure chemical delivery systems, high-temperature re-circulation processes, chemical reclaim and bulk transport applications, slurry systems, and more. Our safe, reliable products offer superior performance, optimized efficiency, and simplified maintenance.

White Knight is able to provide the highest quality fluid handling products through controlled, consistent in-house engineering and manufacturing. Through continued significant investments in engineering and manufacturing, we lead the industry with new technologies and products.

White Knight has received numerous awards for innovation and manufacturing programs. We rigorously manage our quality assurance processes to ensure consistency and reliability. Our quality controls include strict cleanliness procedures and consistent manufacturing processes. For example, high-purity product assembly, testing, and packaging is performed in a Class 100 cleanroom.

Please peruse this manual before installing your White Knight product. It details installation requirements and setup instructions, and provides additional information and accessories for enhanced functionality.

Our team has gone to great lengths to ensure our products serve your needs and meet your requirements.

Further, we provide the highest quality products at the best value, and we back them up with excellent warranties and world class support.

Thank you for your confidence and trust in White Knight products.

Sincerely,

White Knight Fluid Handling





1. Product Information

1.1 Specifications & Performance

Model	PSA030	PSASD030
Max Flow Rate*	24.7 lpm (6.53 gpm)	24.2 lpm (6.4 gpm)
Displacement Per Cycle*	0.074 liters (0.019 gal)	0.074 liters (0.019 gal)
Cycles per min	333 max	364 max
Air Connection	1/4 in	1/4 in
Weight	3.3 kg (7.28 lb)	3.3 kg (7.28 lb)
Suction Lift*	3 m (10 ft)	Flooded suction
Sound	Pressure**	74 dB(a) at 100 psi 50 CPM 79.9 dB(a) at 100 psi max CPM
	Power**	63.01 dB(a) at 100 psi 50 CPM 69.9 dB(a) at 100 psi max CPM

Max Fluid Temperature	100°C (212°F)
Environmental Temperature	min: 0°C (32°F) max: 50°C (122°F)
Max Supply Air Pressure	7 Bar (100 psi)
Min Startup Air Pressure	1.4 bar (20 psi)
Fluid Path Materials	PTFE, PFA
Non-Fluid Path Materials	PTFE, PFA, PP, Ceramic

Stroke Detection	Fiber optic with or without D10 sensor, or solid state pressure switch (NPN or PNP)
Leak Detection	Fiber optic with or without sensor, or conductivity
Electronic Control	CPC, CPT, or custom. Call for details.

* May vary by configuration or system. Suction lift diminishes over time. Recommended installation level less than 3 ft above source. To calculate displacement, divide flow rate by CPM.
 ** Sound measured in accordance with ISO9614-2:1997.
 *** Dry-run capable PSASD030 pumps require flooded suction and may have reduced warranty. Contact support for details.

PSA030 Performance

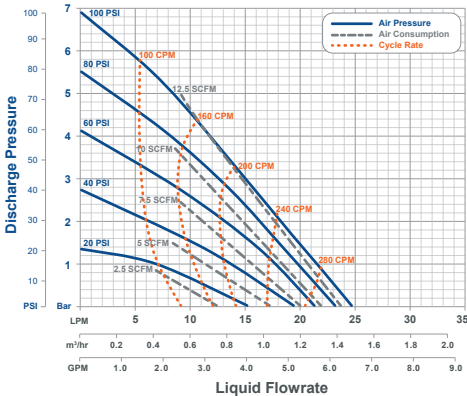

PSASD030 Performance

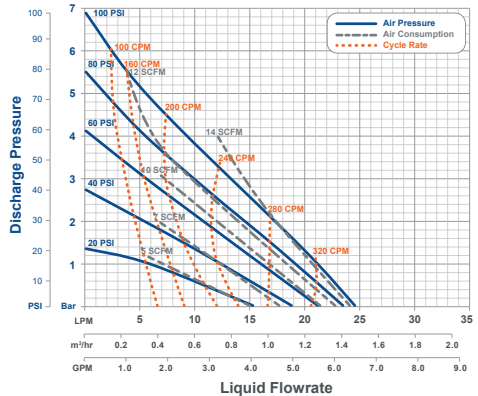

How to Read Charts

Draw a horizontal line at your discharge pressure and vertical line at desired flow rate. At line intersect, estimate required air pressure, resultant cycle rate and air consumption.

Example

At 2 Bar (30 psi) discharge pressure and 70 psi air pressure, PSA030 pumps provide 15 lpm (4 gpm) flow rate, cycle at ~220 CPM, and exhaust 10 SCFM of air.

*Graph is for reference only. Performance was measured utilizing 1/2 in (3/8 in ID) air line and 1-1/4 in (1-1/8 in ID) liquid lines with 1 ft flooded suction. Performance may vary in your system.





1.2 Temperature Limits

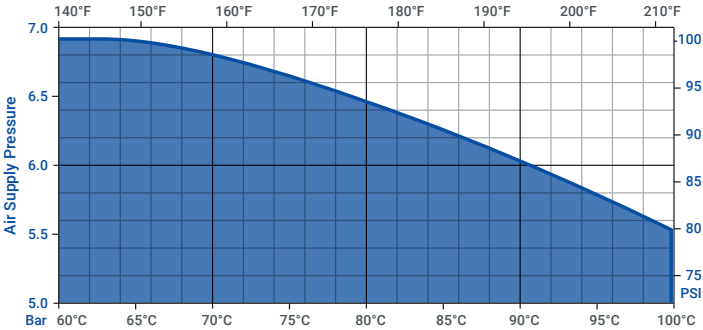

1.3 Dimensions

Dimensions in [mm] in

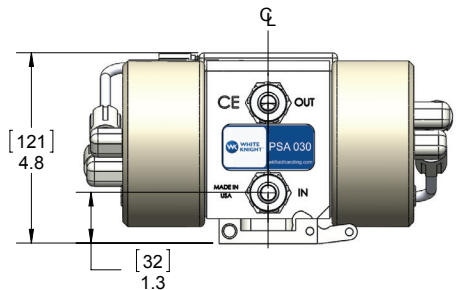
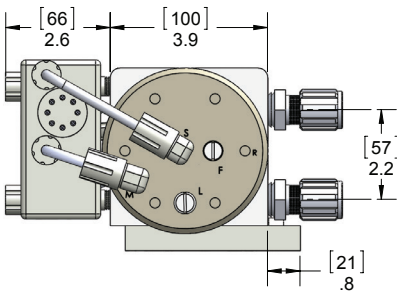
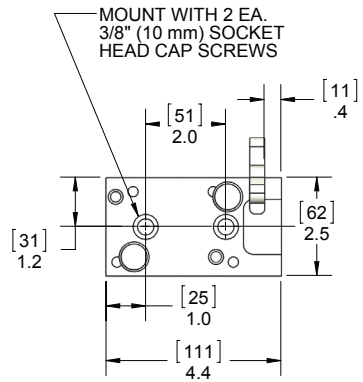
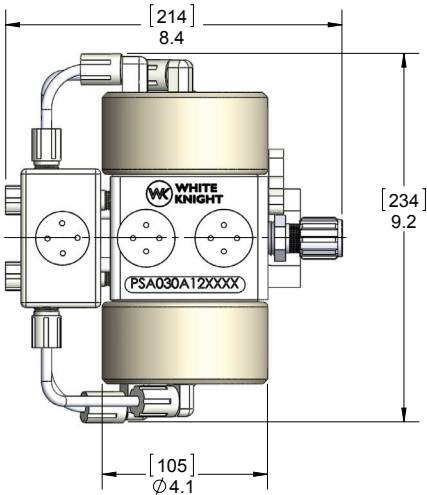



1.4 Bill of Materials

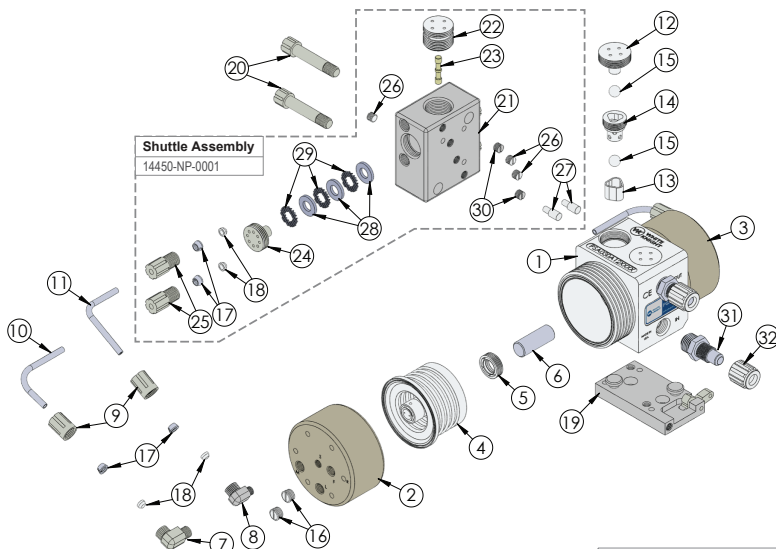

Leak Detect	
Part	Description
14600-XX-0009	LF0 15 ft fiber optic cable with no amplifier
14600-XX-0010	LF1 15 ft fiber optic cable with D10 amplifier
14600-XX-0011	LF2 25 ft fiber optic cable with no amplifier
14600-XX-0012	LF3 25 ft fiber optic cable with D10 amplifier
14600-XX-0031	LC0 15 ft conductivity cable
14600-XX-0040	LC1 25 ft conductivity cable

Stroke Detect with Fiber Optics	
Part	Description
14700-XX-0017	SF0 15 ft fiber optic cable with no amplifier
14700-XX-0018	SF1 15 ft fiber optic cable with D10 amplifier
14700-XX-0019	SF2 25 ft fiber optic cable with no amplifier
14700-XX-0020	SF3 25 ft fiber optic cable with D10 amplifier

Stroke Detect with Pressure Switch	
Part	Description
14900-NP-0004	SP1 Single NPN Switch
14900-NP-0003	SP2 Dual NPN Switches
14900-NP-0001	SP4 Single PNP Switch
14900-NP-0002	SP5 Dual PNP Switches

Fittings	(Type, Size, Option)	Assemblies	Body Inlet Only (Nut not included)
Flaretek Compatible	1/4 in. F04	14510-PF-0016	7200-PF-0001
	3/8 in. F06	14510-PF-0001	7200-PF-0002
	1/2 in. F08	14510-PF-0002	7200-PF-0003
Tube Out	3/4 in. F12	14510-PF-0003	7200-PF-0004
	3/8 in. T06	7120-PF-0001	
	1/2 in. T08	7120-PF-0002	
Weldable	3/4 in. T12	7120-PF-0003	
	1/2 in. W08	7300-PF-0001	
Pillar S-300	1/4 in. P04	14530-PF-0025	7400-TE-0031
	3/8 in. P06	14530-PF-0012	7400-TE-0023
	1/2 in. P08	14530-PF-0001	7400-TE-0001
	3/4 in. P12	14530-PF-0002	7400-TE-0002
FNPT	1/4 in. N04	7100-TE-0001	
	3/8 in. N06	7100-TE-0002	
	1/2 in. N08	7100-TE-0003	
	3/4 in. N12	7100-TE-0007	
Synchro-Flare	3/8 in. S06	14520-TE-0009	7010-TE-0001
	1/2 in. S08	14520-TE-0001	7010-TE-0003
	3/4 in. S12	14520-TE-0002	7010-TE-0002
Primelock	1/4 in. L04	14570-PF-0013	7800-TE-0013
	3/8 in. L06	14570-PF-0014	7800-TE-0014
	1/2 in. L08	14570-PF-0001	7800-TE-0001
	3/4 in. L12	14570-PF-0002	7800-TE-0002
Plugged	B00	7130-TE-0001	

PSA30 BILL OF MATERIALS			
Item	Part	Description	Qty.
1	1125-TE-0017	Pump Body	1
2	2127-EP-0014	Head, Right	1
3	2127-EP-0015	Head, Left	1
4	14300-MP-0013	Bellows Assembly	2
5	5143-MP-0001	Shaft Seal	2
6	5144-PF-0024	Shaft	1
7	6030-NP-0002	Gripper Elbow, 1/4" NPT x 1/4"	2
8	6030-NP-0001	1/8" Npt X 1/4" Elbow	2
9	6070-NP-0001	1/4" Female Gripper Nut	4
10	10071-PF-0009	1/4" Tubing	2
11	10071-PF-0008	1/4" Thick Wall Tubing	2
12	4140-TE-0001	Top Check Plug	2
13	4135-MP-0006	Check Seat	2
14	4142-MP-0004	Check Cage	2
15	4100-MP-0004	1/2" Check Ball	4
16	10040-TE-0003	1/4" NPT Plug	4
17	6080-KF-0001	1/4" Gripper	8
18	6080-TE-0001	1/4" Ferrule	8
19	14200-NP-0006	Base Plate Assembly	1
20	10010-NP-0007	Shuttle MountScrew	2
21	14400-NP-0006	Shuttle Body with Sleeve	1
22	6530-TE-0001	Shuttle End Cap	2
23	6560-CE-0001	Shuttle Spool	1
24	6150-NP-0004	Cap, Muffler	2
25	6070-NP-0004	1/4" Male Gripper Nut	4
26	10040-TE-0002	1/8" NPT Plug	3
27	10020-NP-0003	Shuttle Alignment Pin	2
28	6140-FP-0003	Baffle	6
29	6140-PP-0003	Baffle Spacer	6
30	10040-TE-0015	1/8" NPT Vent Plug	2
31	7200-PF-0003	1/2" Flaretek® Body	2
32	7210-PF-0003	1/2" Flaretek® Nut	2





2. Installation

2.1 Precautions

Handling

Do NOT lift pump by shuttle valve assembly nor air tubing.

Installation Orientation

PSA030 pumps must be installed in an upright position. The check valves are actuated by gravity and/or flow, and they will not seat if the pump is not upright.

Timer Mode

PSA030 pumps require an end of stroke detection mechanism (pressure switch) to prevent over stroking in timer mode. Operating a PSA030 in timer mode without stroke detection will void the pump warranty.

Required Air Flow (Shuttle Valve)

PSA030 pumps require 1/4 in minimum orifice with unrestricted air flow.

Required Air Flow (Solenoid Valve)

PSA030 pumps require a 0.75 Cv solenoid. Using a reduced Cv will reduce flow rates. Using a valve with more than 20% greater Cv will change operating parameters, reduce pump life and void the warranty.

Under Supply of Air

PSA030 pumps operate erratically or stall when air supply is insufficient. Ensure use of air supply pressures higher than averaged air consumption lines in performance charts. Air supply lines and fittings must meet minimal inner diameter requirements shown in the installation instructions.

Air Supply Pressure

Operating PSA030 pumps ~35% below max air pressure may significantly extend pump life. PSA030 pumps require 20 psi minimum air pressure. Operation above 7 Bar (100 psi) may damage the pump and void the warranty.

Suction Lift

PSA030 pumps have an initial suction lift capacity of 3 ft. For best results minimize suction lift.

Liquid Inlet/Outlet Connections

PSA030 liquid ports are not NPT nor any other standard. Use of connectors other than those supplied by White Knight will damage the pump and void the warranty.

Liquid Line Restriction

PSA030 pumps may be controlled by closing liquid outlet lines. However, restricting liquid supply lines increases wear and should be avoided. Do NOT pump against a closed liquid inlet. It will damage the pump and void the warranty.

Running Dry

PSA030 pumps use the pumped liquid to lubricate their shafts. The pumps will cycle faster and wear more than normal when run dry, which may cause damage and loss of self-prime abilities. Standard models should not be run dry after start-up and are not warranted under dry run conditions. Dry-run capable PSASD030 models may run dry for short periods. Warranty of dry-run models is one-year. Extended warranties are available.

Pulse Dampener with Shuttle Valve

Air supply pressure to PSA030 pumps should be at least ten psi higher than the liquid line pressure when using a pulsation dampener. Failure to do so may cause erratic operation.

Cross Contamination

PSA030 pumps use porous material that may retain chemicals. Take precautions to avoid cross contamination.



2.2 Warnings

Pressurized Material



Pumps in use contain pressurized materials. Eliminate liquid and air pressure via shut off valves before pump is serviced or removed from the system.

High Temperature



Heat may transfer to exterior surfaces when pumps operate with high temperature fluids. Avoid direct contact with the pump when high temperature fluids are present.

Hazardous Chemical



Use appropriate personal protective equipment when handling pump. Reference Material Safety Data Sheet (MSDS) for information specific to your chemicals.

Loud Noise



Pump exhaust air contributes to work area noise levels. Only operate pumps with approved muffler media, and use ear protection in noisy conditions.

2.3 Advantages

Head Pressure / Dead-Head

PSA030 pumps can be controlled by adjusting their liquid outlet pressures and can be installed with head pressures up to dead-head (e.g. equal liquid and air pressures) with no damage to the pump.

Thermal Cycling

PSA030 pumps require no maintenance when operated within their performance range, even in thermal cycling applications.

2.4 Environment & System

Oversized Inlet Line

Pumps operate optimally with liquid inlet lines larger than the liquid outlet lines. This reduces strain on the bellows and may reduce pulsation in the pump outlet.

Clean Supply Air (CDA)

PSA030 pumps require use of Class 2 air for particles and moisture per ISO 8573-1. Use 10 micron filter; maintain -40°C dew point. A point-of-use filter is recommended during first six months of operation in new fabs/systems due to high risks of debris that can damage pumps and void warranty.

Flammable Solvents

PSA030 pumps are not constructed from conductive materials. System that pump flammable solvents should be properly grounded to avoid ignition by static charge. A River's Edge test of isolative pumps with flammable liquids indicated that liquids must be grounded and other procedures should be followed. Copy of test available.

Pumping Liquids Near Boiling Point

Minimizing suction lift reduces pulsation and the potential for boiling or outgassing of liquid in the inlet of the pump. Although reciprocating pumps can pull suction lift, pump performance and life increase when suction lift is minimized or eliminated.

Abrasive Slurry

Pumping abrasive slurry may accelerate wear of components. PSA030 pumps are warranted when used with slurry. However, normal wear is not covered by warranty.

Environmental Temperature

PSA030 pumps are rated for 0°C (32°F) - 50°C (122°F) environmental temperatures. Do not freeze fluid in pump. Operation below 0°C may accelerate wear. Normal wear is not covered by warranty.



2.5 Installation Instructions

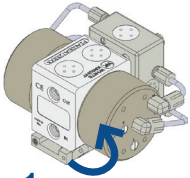

1. Move lever to up position.

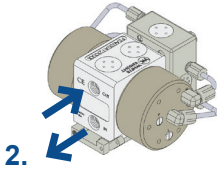

2. Slide base plate forward or pump body backward.

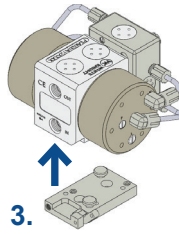

3. Lift pump off of base plate.

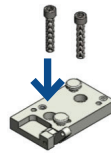

4. Screw base plate to surface with 3/8 in or 10 mm socket head cap screws into pre-drilled holes.

Pull-back dismount is standard. See steps 4.1-4.3 for forward dismount.

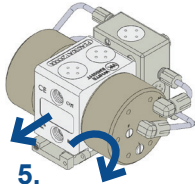

5. Set pump on base knobs; slide it forward. Set lever to down position.

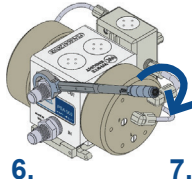

6. Attach fittings to pump. Tighten to 20 inch-lbs.

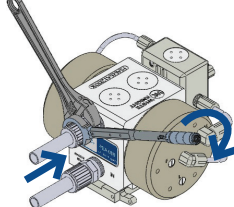

7. Attach tubes and fittings per manufacturer instructions. Use backer wrench to hold fitting in place at pump.

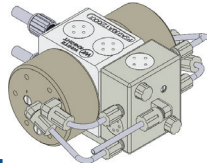

8. Affix supply air via 1/4 in FNPT port on shuttle valve. Air line must be 3/16 in minimum orifice.

Push-Forward Dismount Configuration Setup

Replace step 5 with steps 4.1-4.3 to re-configure the base plate to push-forward dismount configuration.

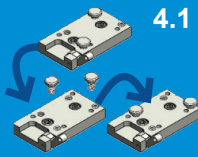

4.1 Move knobs to opposite sides.

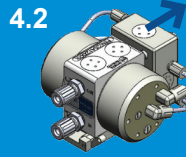

4.2 Set pump on base knobs; slide it backward.

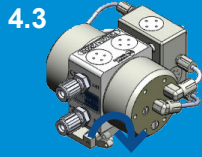

4.3 Move lever down to locked position.

Install with Rigid Base Plate *Requires push-forward dismount configuration (steps 4.1-4.3)

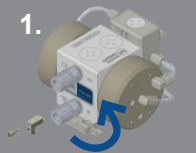

1. Remove L bracket. Set lever in neutral (up) position.

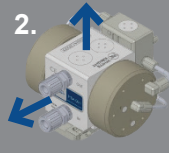

2. Slide pump forward; lift it off base plate.

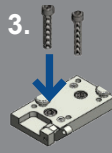

3. Fix work station. See step 4 above.

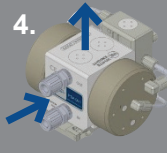

4. Return pump to base plate.



5. Move lock lever to down position. Reattach L bracket. Tighten to 12 in-lb.

Liquid Inlet/Outlet

Liquid ports are not NPT nor any other standard. Use of connectors other than those supplied by White Knight will damage the pump.





2.6 Shuttle Service Instructions

Follow instructions below to inspect or service White Knight shuttle valves. If a pump has stopped, ensure all recommendations in this manual are followed and that there are no air supply issues (i.e. closed air valve, damaged regulator, oil in air line, etc.).

Do not lubricate or oil any of the shuttle components. White Knight shuttle valves do not require any lubrication.

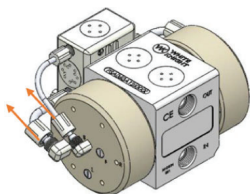

1. Remove nuts on each air fitting on each pump head.

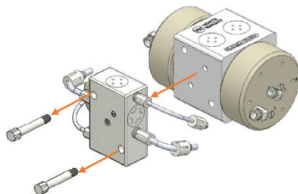

2. Unscrew both shuttle mounting bolts, and pull the shuttle from the pump.

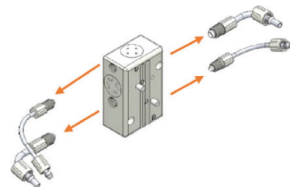

3. Remove the airlines from both sides of the shuttle valve by unscrewing the air fittings.

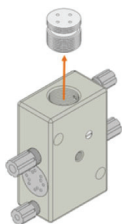

4. Unscrew top shuttle end cap using the shuttle end cap tool.

Part: 12100-PV-0083

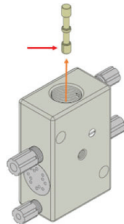

5. Carefully remove ceramic spool from shuttle valve; it may break if dropped.

If the ceramic spool in your pump has a flat feature, it is critical that it is oriented towards the bottom of the pump when the shuttle valve is reassembled.

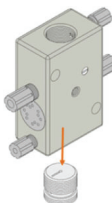

6. Unscrew bottom end cap using the shuttle end cap tool.

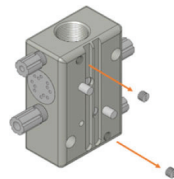

7. Unscrew both 1/8 in NPT plugs that have an orifice in the center.

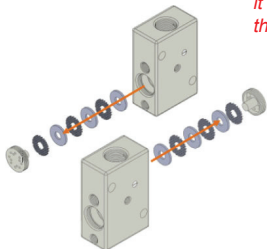

8. Remove muffer cap from left side using the muffer cap tool. Remove muffer media and note the order of the pieces. Repeat this step for muffer cap and muffer media on the right side.

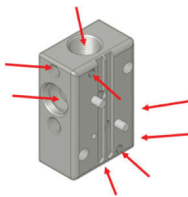

9. Blow out shuttle valve with CDA or N2. Ensure no residue or debris is in any areas indicated above. Debris or residue in these areas may hinder pump performance.



10. Clean the ceramic spool with IPA, and dry it using CDA or N2.

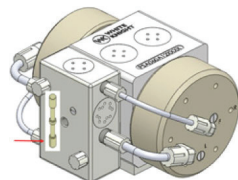

11. Reassemble shuttle and reattach it to the pump by following the above steps in reverse.
If the spool in your pump has the flat feature, ensure it is oriented towards the bottom of the pump when the shuttle valve is reassembled.





3. Control & Monitoring

Programmable Control

White Knight CPT-1 controllers monitor and adjust run mode, flow rate, leak detection and other pump operations.



D10 Amplifier Electrical Hookups & Dimensions

White Knight recommends Expert™ D10 amplifier for use with fiber optic stroke and leak detection assemblies.

Standard Models and Main Unit

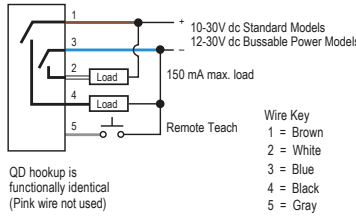

Sub-Units

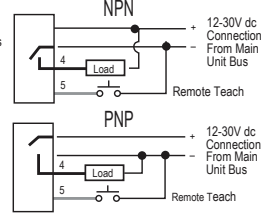

- Wire Key
1 = Brown
2 = White
3 = Blue
4 = Black
5 = Gray

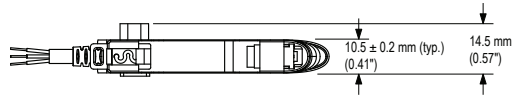

Single Sensor Design

PSA030 pumps can use only a single fiber optic sensor at a time. The probe may be installed in the "F" port on either side of the pump. White Knight offers PFA, PFH, and PFU pumps for dual fiber optic use.

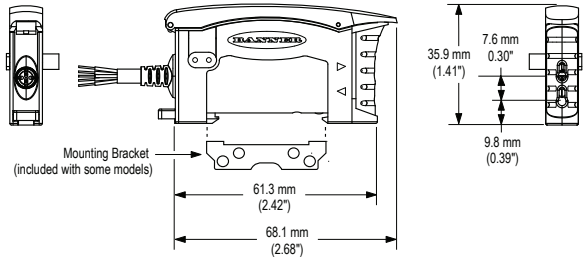

3.1 Fiber Optic Stroke Detection Installation

1. Remove stroke detect probe from fiber optic assembly.
2. Replace NPT plug in "F" port with stroke detect probe. Hand-tighten.
3. Insert the fiber optic cable until it seats at the bottom of the probe.
4. Lower ferrule and gripper until snug against probe and hand tighten female gripper nut.

Fiber Optic Sensors

Fiber optic sensors melt if used at >130°C (266°F), resulting in leak or end of stroke detection failure.

5. Open the top and slide the front face of the D10 up. Press the fiber optic ends into the holes on its front. Slide the face down to lock cables in place.





3.2 Calibrating D10 Amplifier for Stroke Detection

When calibrating the D10 Amplifier for stroke detection, the pump should be in the same operating conditions it will be in during normal operation (i.e. supply air pressure, back pressure, etc.). The Fiber Optic must be installed as per the instructions in section 3.1.

Calibration:			
	Push Button	Remote Line	Result
Access Dynamic TEACH Mode	Press and hold dynamic push button >2 seconds. 	Hold Remote line low (to ground) >2 Seconds. 	<ul style="list-style-type: none"> Power LED: OFF Output LED: OFF Bar graph: LO & DO Alternately Flashing
TEACH Sensing Conditions	<ul style="list-style-type: none"> Hold push button. Operate pump normally for 15 seconds. 	<ul style="list-style-type: none"> Hold remote line low (to ground). Operate pump normally for 15 seconds. 	<ul style="list-style-type: none"> Power LED: OFF Output LED: OFF Bar graph: LO & DO Alternately Flashing
Return to Run Mode	Release button 	Release remote line/switch 	<p>Teach Accepted Power LED: ON Bar graph: One LED flashes to show relative contrast (successful setup requires minimum value of 4). Sensor returns to Run Mode with new settings.</p> <p>Teach Unaccepted Power LED: OFF Bar graph: #1, 3, 5, 7 alternately flash to show failure to sense. Sensor returns to Run mode without changing settings. Set up again if value shows <4.</p>

Upon completion of a successful learning cycle, the D10 Amplifier will continuously learn and self-teach to maintain the same cycle rate count readings.





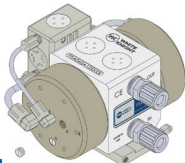
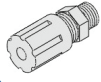
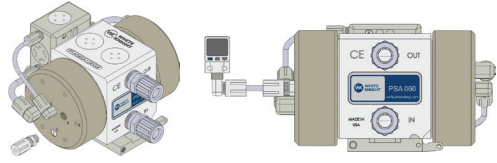

3.3 Single Pressure Switch Stroke Detection Installation

-  1. Remove plug from "F" port.
-  2. Attach NPT gripper to "F" port.
-  3. Attach elbow assembly to pressure switch. Loosen female gripper nuts, and insert air tube between them. Hand tighten gripper nuts.

After your device is connected, you must set the switch point. If operating above 60 psi air supply, the set point is 43 psi (0.296 MPa), otherwise it is 18 psi (0.124 MPa). Each system is unique so values may need to be adjusted to your specific application. As the exhaust system loads, it may be necessary to adjust the set point.

3.4 Dual Pressure Switch Stroke Detection Installation

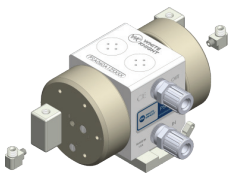
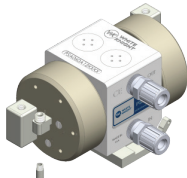
Perform all instructions to both sides of the pump.

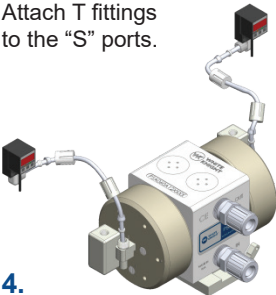
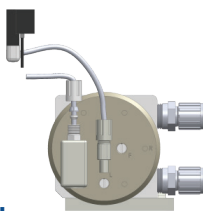
-  1. Attach T fittings to the "S" ports.
-  2. Attach mufflers to the T fittings.
-  3. Attach elbow assemblies to pressure switches.
-  4. Loosen female gripper nuts on elbow assemblies and T fittings. Insert tubing and hand-tighten gripper nuts.
-  5. Affix supply air via 1/4 in FNPT QEV ports on both sides. Air supply must be 1/4 in minimum orifice to source.

After your device is connected, you must set the switch point. If operating above 60 psi air supply, the set point is 43 psi (0.296 MPa), otherwise it is 18 psi (0.124 MPa). Each system is unique so values may need to be adjusted to your specific application. As the exhaust system loads, it may be necessary to adjust the set point.





3.5 Pressure Switch Stroke Detection Electrical Hookups

NPN

I/O circuit diagram

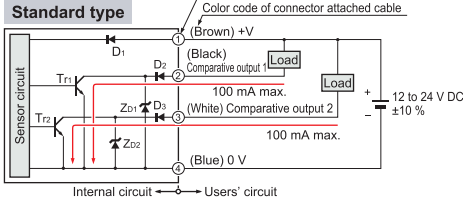

Symbols ...D1 to D3 : Reverse supply polarity protection diode
 Zb1, Zb2 : Surge absorption zener diode
 Tr1, Tr2 : NPN output transistor

PNP

I/O circuit diagram

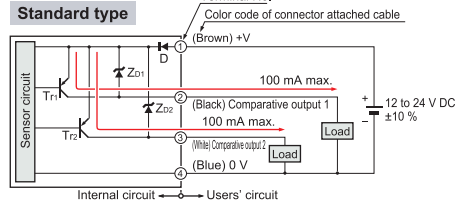

Symbols ...D : Reverse supply polarity protection diode
 Zb1, Zb2 : Surge absorption zener diode
 Tr1, Tr2 : PNP output transistor

Assembly dimensions

Mounting drawing with DP-10

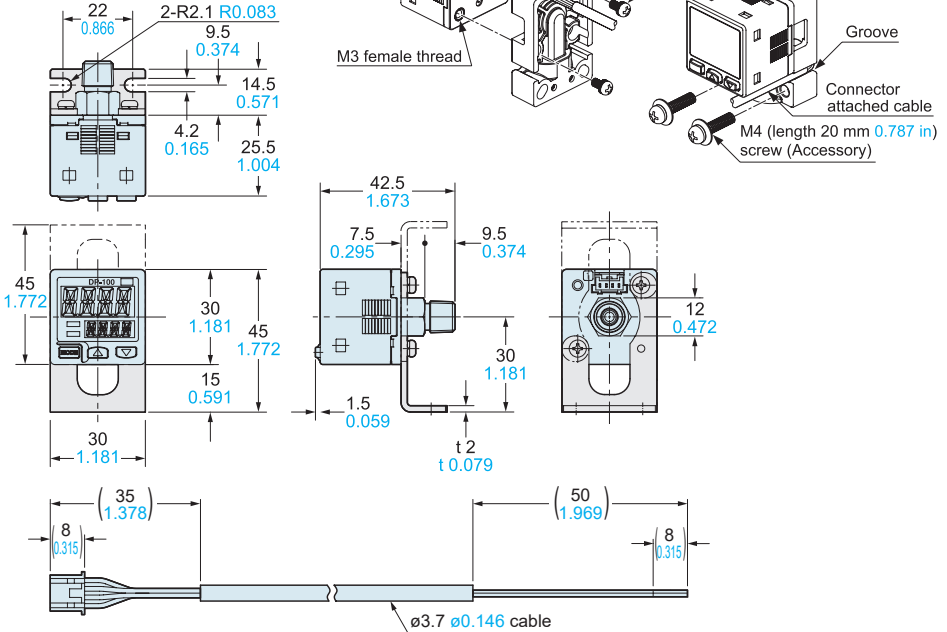



3.6 Conductivity Leak Detection Installation

Leaks are identified if conductive fluid contacts a sensor. Sensor provides a Sink (NPN) or Source (PNP) signal, depending on the wire setup. See the wiring diagrams below.

Conductive leak detection does not qualify for use in explosion-proof environments. Conductive fluid required.

See below for elbow out configuration.

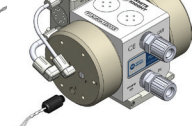
-  Remove leak adapter from assembly.
-  Replace NPT plug in "L" port with probe. Hand Tighten. Attach cable to signal translator (e.g. PLC).

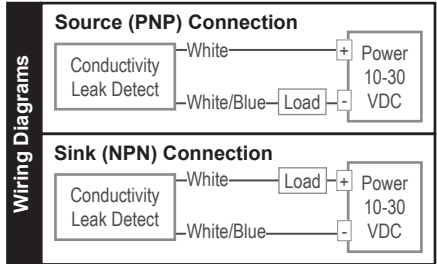

3.7 Fiber Optic Leak Detection Installation

D10 amplifier must be calibrated before attaching fiber optic probes to the pump. Fiber optic sensors can melt if used at >130°C (266°F), causing leak detect failure.

See below for elbow out configuration.

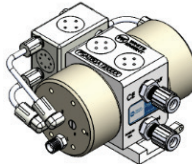
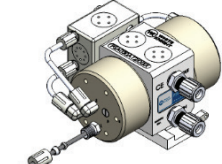
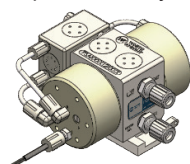
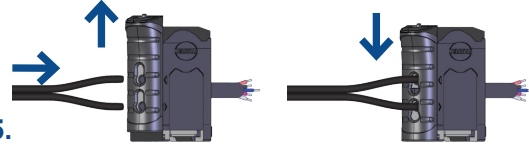
-  Remove leak adapter and leak detect probe from fiber optic assembly.
-  For straight out configuration replace NPT plug in "L" port with the probe. Hand-tighten.
-  Insert the fiber optic cable until it contacts the bottom of the probe.
-  Lower ferrule and gripper until snug against the probe. Hand tighten female gripper nut.
-  Open the top and slide the front face of the D10 up. Press the fiber optic ends into the holes on its front. Slide the face down to lock cables in place.

For elbow out configuration:

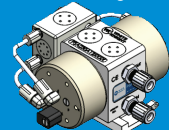
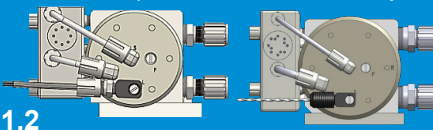
-  Replace NPT plug in "L" port with elbow adapter.
-  Attach fiber optic or conductivity leak detect probe per instructions above.





3.8 Calibrating D10 Amplifier for Leak Detection

Step 1: Power On D10 Amplifier & Set "Dark Operate" Mode:

	Push Button <i>0.04 s ≤ "Click" ≤ 0.8 s</i>	Remote Line <i>0.04 s ≤ T ≤ 0.8 s</i>	Result
Access Setup Mode	Press and hold both buttons > 2 seconds. 	Double-pulse remote line 	<ul style="list-style-type: none"> Green Power LED turns OFF. Output LED remains active. Icons continue to display current setup. Bargraph turns OFF.
Select Settings	Press either button until LEDs show desired settings. 	Pulse the remote line until LEDs show desired settings. Note: Double-pulsing remote line causes setting to "back up" one step.	Sensor toggles through these setting combinations: LO - Normal Speed - No Delay (default) DO - Normal Speed - No Delay LO - High Speed - No Delay DO - High Speed - No Delay LO - Normal Speed - Delay DO - Normal Speed - Delay LO - High Speed - Delay DO - High Speed - Delay
Return to Run Mode	Press and hold both buttons > 2 seconds. 	Hold remote line low > 2 seconds. 	<ul style="list-style-type: none"> Green Power LED turns ON. Sensor returns to Run mode with new settings.

Step 2: Access "Single-Point Dark Set" Mode

	Push Button <i>0.04 s ≤ "Click" ≤ 0.8 s</i>	Remote Line <i>0.04 s ≤ T ≤ 0.8 s</i>	Result
Access Set Mode	Press and hold static button > 2 seconds. 	Single-pulse remote line 	<ul style="list-style-type: none"> Power LED: OFF. Output LED: ON (push button) OFF (remote line) Static LEDs: LO & DO alternately flashing

Step 3: Set Sensing Condition

Set condition to "leak detection" sensing while probe tip is submerged in liquid. Then, remove the leak probe from liquid and reinserted into the "L" port. Amplifier will now signal when moisture is detected on the probe tip.

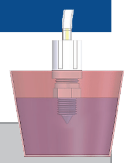

	Push Button <i>0.04 s ≤ "Click" ≤ 0.8 s</i>	Remote Line <i>0.04 s ≤ T ≤ 0.8 s</i>	Result
Set Sensing Condition	<ul style="list-style-type: none"> Present sensing condition Five-click static button 	Present sensing condition • Five-pulse remote line 	<ul style="list-style-type: none"> Power LED: ON. Output LED: ON (push button) OFF (remote line) Bargraph: 4 indicators flash. Sensor returns to Run mode with new settings or <ul style="list-style-type: none"> Power LED: ON. Output LED: ON (push button) OFF (remote line) Bargraph: #1, 3, 5, 7 flash for failure. Sensor returns to Set sensing condition.





4. Ordering Instructions

Required (Default Model)

Additional Options (Blank if not needed)

PSA030	-F08	-LF0	-SF0	-TF08	-VX0	
1	2	3	4	5	6	7 Rev

Options 1-3 are required. Leave Additional Options blank if not desired. Only add Outlet if different than Inlet.

Default options are highlighted

1. Pump Model	
Standard	PSA030
Dry-Run	PSASD030

2. Check Ball Material	
PTFE Check balls	blank
PFA Check balls	F

3. Inlet Fitting		
<i>Front straight only</i>		
	1/4 in.	F04
	3/8 in.	F06
	1/2 in.	F08
	3/4 in.	F12
	3/8 in.	T06
	1/2 in.	T08
	3/4 in.	T12
	1/2 in.	W08
	3/4 in.	W12
	1/4 in.	P04
	3/8 in.	P06
	1/2 in.	P08
	3/4 in.	P12
	1/4 in.	N04
	3/8 in.	N06
	1/2 in.	N08
	3/4 in.	N12
	3/8 in.	S06
	1/2 in.	S08
	3/4 in.	S12
	1/4 in.	L04
	3/8 in.	L06
	1/2 in.	L08
	3/4 in.	L12

4. Leak Detection	
No leak detection	blank
15 ft fiber optic cable with no amplifier	LF0
15 ft fiber optic cable with D10 amplifier	LF1
25 ft fiber optic cable with no amplifier	LF2
25 ft fiber optic cable with D10 amplifier	LF3
15 ft conductivity cable	LC0
25 ft conductivity cable	LC1

5. Stroke Detection	
No stroke detection	blank
15 ft fiber optic cable with no amplifier	SF0
15 ft fiber optic cable with D10 amplifier	SF1
25 ft fiber optic cable with no amplifier	SF2
25 ft fiber optic cable with D10 amplifier	SF3
Single NPN Pressure Switch	SP1
Dual NPN Pressure Switches * (Includes two DP2 pressure switches)	SP2
Single PNP Pressure Switch	SP4
Dual PNP Pressure Switches * (Includes two DP2 pressure switches)	SP5

7. Shuttle	
Gravity reset with standard exhaust	blank
No shuttle, standard ports * (No pressure switches included) <i>Sensors are required for operation.</i>	VX0
Gravity Reset with Remote Exhaust	VG1

* White Knight shuttle valve not included.



Timer mode operation requires end-of-stroke detection. Use of timer mode without stroke detection voids the warranty.

6. Outlet Fitting			
<i>Straight only.</i>			
<i>Select Top or Front.</i>			
		Front	Top
<i>Same as Inlet</i>		blank	n/a
	1/4 in.	FF04	TF04
	3/8 in.	FF06	TF06
	1/2 in.	FF08	TF08
	3/4 in.	FF12	TF12
	3/8 in.	FT06	TT06
	1/2 in.	FT08	TT08
	3/4 in.	FT12	TT12
	1/2 in.	FW08	TW08
	3/4 in.	FW12	TW12
	1/4 in.	FP04	TP04
	3/8 in.	FP06	TP06
	1/2 in.	FP08	TP08
	3/4 in.	FP12	TP12
	1/4 in.	FN04	TN04
	3/8 in.	FN06	TN06
	1/2 in.	FN08	TN08
	3/4 in.	FN12	TN12
	3/8 in.	FS06	TS06
	1/2 in.	FS08	TS08
	3/4 in.	FS12	TS12
	1/4 in.	FL04	TL04
	3/8 in.	FL06	TL06
	1/2 in.	FL08	TL08
	3/4 in.	FL12	TL12

Revision	
No revision	blank
<i>Contact support for revision level or copy exact code activation details. Configured part numbers are not Copy Exact Part Numbers. support@wkfluidhandling.com</i>	





5. Pump Service

Pumps fully rebuilt by White Knight, certified rebuilders, or technicians certified by White Knight receive full warranty renewal. Details below.

White Knight Rebuilds

Request factory rebuilds by web form at: <https://wkfluidhandling.com/support/rma/>. An RMA# will be provided after processing.

**Customers must follow decontamination instructions in Section 4.4 when returning a pump to White Knight.*

Certified Rebuilders

White Knight's global network of certified rebuilders expedite rebuild turn-around time and minimize shipping costs. Find certified rebuilders at: <https://wkfluidhandling.com/rebuilders/>

Rebuild Pump as Certified Technician

White Knight offers trainings to certify technicians to rebuild pumps. Technicians who pass the training are issued a two-year certification. During the two years, parts in pumps rebuilt by the technician receive a full warranty. See: <https://wkfluidhandling.com/virtual-rebuilds/>

5.1 Rebuild Kits & Parts

Rebuild kit for PSA030 is RBPSA030-1. Rebuild kit for PSASD030 is RBPSASD030-1 (labor not included). To request rebuilds by White Knight, use RBPSA030-5 or RBPSASD030-5, respectively (labor included).

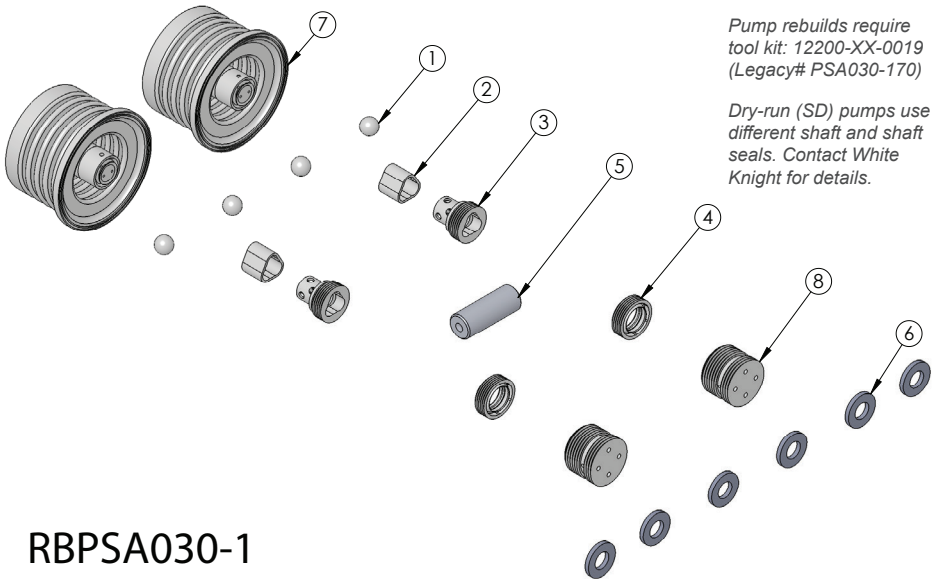

Pump rebuilds require tool kit: 12200-XX-0019 (Legacy# PSA030-170)

Dry-run (SD) pumps use different shaft and shaft seals. Contact White Knight for details.

RBPSA030-1

ITEM NO.	PART NUMBER	DESCRIPTION	QTY.
1	4100-MP-0004	CHECK BALL 1/2"	4
2	4135-MP-0006	CHECK SEAT BOTTOM HI-FLOW 25L & 30L	2
3	4142-MP-0004	CHECK CAGE TOP HI-FLOW 25L & 30L	2
4	5143-MP-0001	SEAL, SHAFT, 30L	2
5	5144-PF-0024	SHAFT, SOLID, PFA, 30L	1
6	6140-FP-0003	BAFFLE POROUS POLY 25L & 30L	6
7	14300-MP-0013	30L S- Series H & A Bellows Assembly	2
8	6530-TE-0001	SHUTTLE END CAP- 5GPM	2





5.2 Return Pump for Service

Follow decontamination instructions when returning a pump for service.

DO NOT REMOVE PAGE FROM MANUAL.

Copy page from manual or download at <https://wkfluidhandling.com/support/rma/>.

Decontamination Instructions

PRINT COMPLETED DECONTAMINATION CERTIFICATION. IT MUST BE INCLUDED IN YOUR RMA SHIPMENT.

White Knight products are designed for use with caustic and otherwise dangerous liquids. Handle every product as if it contains dangerous chemicals whether or not it actually does.

- Only those with adequate safety training should attempt to handle used pumps.
- Wear adequate safety gear appropriate for chemicals that have been in the pump.
- Review relevant Material Safety Data Sheets (MSDS) before handling the pump.
- Review emergency numbers for use in event of an accident.
- Prepare Ph papers, showers, antidotes, clean-up equipment, neutralizers, and other safety devices used to detect, neutralize or minimize effects of chemicals described in appropriate MSDS documents.

Rinse with DI Water

Circulate DI water through pump for twenty minutes before disassembly and/or double bagging for shipment. If pump is nonfunctional, force DI water from inlet through outlet for 40 minutes before shipment preparations.

Remove Pump from Station:

1. Disconnect liquid tubing connectors from front of pump (opposite shuttle valve).
2. Plug NPT fittings with PTFE plug, Flare fittings with flare nose cover and cap, or other plug or cap as recommended by connector supplier.
3. Disconnect air supply tubing from face of shuttle valve.
4. Loosen mount screw from base plate. (Note: do not remove screw from base plate).
5. Remove base plate using proper tool for the fastening devices (e.g. Allen wrench or screw driver).
Note: Base plate may stay if needed for replacement pump to be used.
6. Return all removed parts to the pump.

Return Pump to White Knight:

1. Rinse pump with DI water as described above after removing it from its station.
2. Drain remaining DI water from the pump inlet and outlet liquid tubing connectors.
3. Plug liquid outlets as described in the Remove Pump from Station section above.
4. Dry the pump, double bag it, and seal it in thick polyethylene bags.
5. Return the pump to its original packaging.
6. Include MSDS for the chemical that the pump was handling in the box with the pump.
7. Obtain RMA number from White Knight and write it on the outside of the box.
8. Ship to White Knight following all rules, regulations and laws regarding shipment of dangerous materials. Ship freight pre-paid. No collect shipments will be accepted. Unauthorized use of White Knight shipping accounts will result in the adding of freight to the bill in addition to a service charge.

Include All Pump Components:

Pumps returned to White Knight for evaluation, service or repair must be complete with all components, including but not limited to base plate, mount screws, tubing connectors, tubing connector caps, flare noses, shuttle valves, mufflers, and tubing. Missing parts will be added to the pump and charged to the customer.





DO NOT REMOVE PAGE FROM MANUAL.

Copy page from manual or download at <https://wkfluidhandling.com/support/rma/>.

Decontamination Certification

COMPLETE AND PRINT THIS FORM. IT MUST BE INCLUDED IN YOUR RMA SHIPMENT.

I, the undersigned employee of _____, certify that all decontamination and safety procedures described in Decontamination Instructions section have been followed for return of product below.

RMA#: _____

(We cannot process returns without an RMA number.)

Serial#: _____

(We cannot process returns without a product serial number.)

Metal Exposure:

(Check all that apply. Write in other metals if necessary.)

Product was used in a Metal Process. Yes No

Product was used in a Copper Metal Process. Yes No

Product was used with:

- Aluminum Cobalt Gold Lead Nickel Platinum Silver Tin Titanium
- Tungsten Zinc Other: _____

Chemical Exposure:

(Check all that apply. Write in other chemicals if necessary.)

Product was NOT used in chemicals (DI Water only).

Product was used in chemicals.

- Ammonia Ammonium Hydroxide Hydrochloric Acid Hydrofluoric Acid Hydrogen Peroxide IPA
- Nitric Acid Phosphoric Acid Sulfuric Acid Other: _____

Shipping Information:

Please indicate metal processes to which the product has been exposed by clearly and conspicuously labeling the outside of the return package with the metal.

Products exposed to Metal Processes must be sent to the following address:

White Knight Fluid Handling
187 East 670 South, Suite B
Kamas, UT 84036

Products NOT exposed to Metal Processes must be sent to the following address:

White Knight Fluid Handling
187 East 670 South, Suite C
Kamas, UT 84036

Print Name: _____

Signature: _____

Date: _____





6. Warranty

White Knight follows strict manufacturing, assembly and testing procedures to ensure consistency and reliability.

White Knight warrants PSA030 pumps and components are free from defects in materials and workmanship for two years from our shipment date or your installation date if provided within 90 days of shipment from our facility.

Failures due to normal wear, misuse, abuse or unauthorized disassembly nullify this warranty.

White Knight does not guarantee the suitability of products for specific applications. White Knight is not liable for any damage or expense resulting from use or misuse of its products in any application. Responsibility is limited solely to repair or replacement of defective products or components.

Prior written, faxed or emailed approval must be obtained from White Knight before returning any product or component for warranty consideration. All determinations regarding cause of failure are made by White Knight, and all decisions regarding warranty fulfillment or nullification are made by White Knight.

THE FOREGOING WARRANTY IS EXCLUSIVE AND IN LIEU OF ALL OTHER WARRANTIES EXPRESSED OR IMPLIED, INCLUDING ANY GUARANTEE OF SUITABILITY FOR ANY PURPOSE. NO VARIATIONS OF THIS WARRANTY SHALL BE HONORED NOR CONSIDERED LEGALLY BINDING, EXCEPT WRITTEN AGREEMENTS SIGNED BY THE CEO OF WHITE KNIGHT FLUID HANDLING.



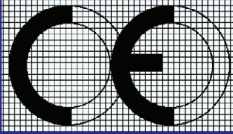

Barclay-Phelps

CE MARKING SPECIALISTS
Hoi Yuen Road, Kwun Tong, Kowloon, Hong Kong

CERTIFICATE & DECLARATION OF CONFORMITY FOR CE MARKING

Company contact details:

White Knight Fluid Handling Inc.
187 E. 670 S., Kamas, Utah, 84036, USA

White Knight Fluid Handling Inc. declares that their:

Bellows Pump Line

PSA030, PSA060, PSA140, PSH030, PSH060, PSH140, PSU030, PSU060, PSU140, PSA015, PSR050, PSR025, PFA030, PFA060, PFA140, PFH030, PFH060, PFH140, PFU030, PFU060, PFU140, PXA030, PXA060, PXA140, PXH030, PXH060, PXH140, PXU030, PXU060, PXU140, PFA015, LHA015, LHA030, LHA070

Diaphragm Pump Line (Non Conductive)

PSD04TE, PSD06TE, PSD08TE, PSD16TE, PSD24TE, PSD04UH, PSD06UH, PSD08UH, PSD16UH, PSD24UH, PSB100

Diaphragm Pump Line (Conductive)

PSD04TC, PSD06TC, PSD08TC, PSD16TC, PSD24TC, PSD04UC, PSD06UC, PSD08UC, PSD16UC, PSD24UC

Legacy Pump Line

PLS30, PLS60, PLS120, PLX30, PLX60, PLX120, PX30, PX60, PX120, PLF30, PLF60, PLF120

Metering Pumps

PPM100, PEM100, PEM050

Plastic Pumps

PHC40-2, PPMC300, PPMA

TPA07 Pressure Transducer

are classified within the following EU Directives as applicable:

- Machinery Directive 2006/42/EC
- Low Voltage Directive 2014/35/EU
- Electromagnetic Compatibility Directive 2014/30/EU
- RoHS 2 Directive 2011/65/EU

and further conform with the following EU Harmonized Standards as applicable:

EN 809:1998+A1:2009 EN 60204-1:2006 + A1:2009 EN 61000-6-2:2005 EN 61000-6-4:2007+A1:2011

Dated: 16 January 2017

Position of signatory: Product Manager **Name of Signatory:** Cory Ammon Simmons

Signed below: on behalf of White Knight Fluid Handling Inc.





Pump Solutions and Accessories



Ultra-Pure Closed-Loop Systems

Automatically maintain laminar flow or steady pressure with metal-free closed-loop pump systems offering stable temperatures, dead-head and suction lift. Control your high purity chemical processes and delivery systems. Simplify process automation to save time, resources and reduce costs.

<https://wkfluidhandling.com/closed-loop/>

- ≤ 140 lpm (36 gpm) flow rates
- ≤ 7 Bar (100 psi) pressures
- ≤ 210°C (410°F) temperatures
- Maintain stable temperatures
- No metals, no corrosion
- No elastomer O-rings, no leaks
- No electric motors, no heat rise

Pulse Dampeners

In-line and pump-mounted pulse dampeners reduce pulsation in fluid systems to improve flow control, increase batch yields, protect components, and minimize maintenance and downtime for repairs. DBA030 dampeners fit 30 and 60 lpm pumps. DBA060 dampeners fit 30, 60 and 140 lpm pumps. DBA140 dampeners fit 60 and 140 lpm pumps.

<https://wkfluidhandling.com/dampeners/>

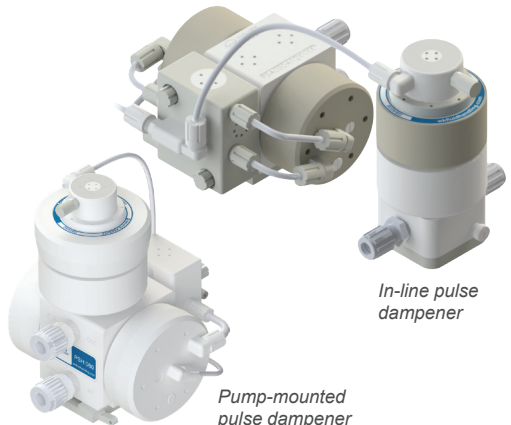

In-line pulse dampener

Pump-mounted pulse dampener





Pressure Regulators

White Knight pressure regulators offer remote piloting capability to maintain system pressure for high-purity chemical circulation loops and systems with multiple tool drops or dispense points. They feature fully-swept PTFE/PFA flow paths. A single back-pressure regulator equalizes upstream fluid pressure across multiple discharge outlets. Forward-pressure regulators control downstream pressure.

<https://wkfluidhandling.com/pressure-regulators/>



Back-pressure regulator

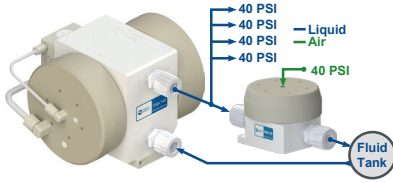

A single back-pressure regulator equalizes upstream fluid pressure for discharge outlets. Each forward-pressure regulator controls fluid pressure for a single discharge outlet.

Forward-pressure regulator

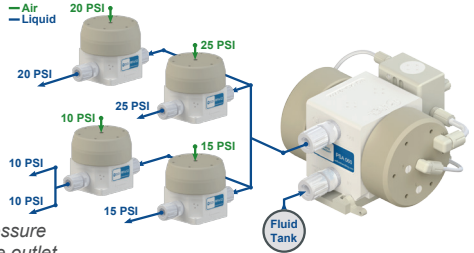

Filter Housings

Two-chamber and four-chamber filter housings provide parallel or series (in-line) operation. Their compact, non-metallic PTFE/PFA designs offer superior containment and high-flow performance within a smaller footprint than traditional housings. They fit many filter types, and enable filters to be changed without disconnecting liquid lines.

<https://wkfluidhandling.com/filter-housings/>



Cycle-Rate Translator

The CPT enables pump replacements in existing tools. It operates a White Knight pump at its optimal cycle rate and scales the operational cycle rate to that expected by the tool.

<https://wkfluidhandling.com/cpt/>

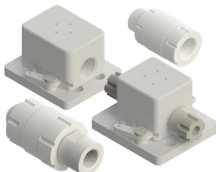

Catcher™ Pre-Filters

White Knight Catcher™ pre-filters protect pumps from wafer shards and other harmful solids. They can be cleaned without disconnecting liquid lines.

<https://wkfluidhandling.com/catchers/>





**WHITE
KNIGHT®**

.....*engineer approved™*

White Knight Support

187 E. 670 S.
Kamas, UT 84036

Phone: 435.783.6040
Toll Free: 888.796.2476
Fax: 435.783.6128

support@wkfluidhandling.com
<https://wkfluidhandling.com/support/>



Part No. 18200-LM-0002



Copyright © 2023 White Knight Fluid Handling | A Graco company
P: 435.783.6040 | support@wkfluidhandling.com | <https://wkfluidhandling.com>

Version 2.2.1 | 5 Dec 2023
Subject to change without notice