



WHITE KNIGHT®

.....engineer approved™

PSA SERIES PUMPS

Ultrapure Pumps for Advanced Chemical Processes

Metal-free pumps with PTFE, PFA flow paths for ultrapure chemical process applications. PSA Series pumps are capable of 100°C (212°F) fluid temperatures and 7 Bar (100 psi) air pressures. PSASD models can run dry for more than one hour without pump damage.

Advanced Pump Technologies

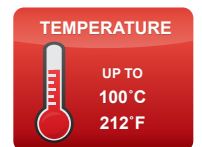
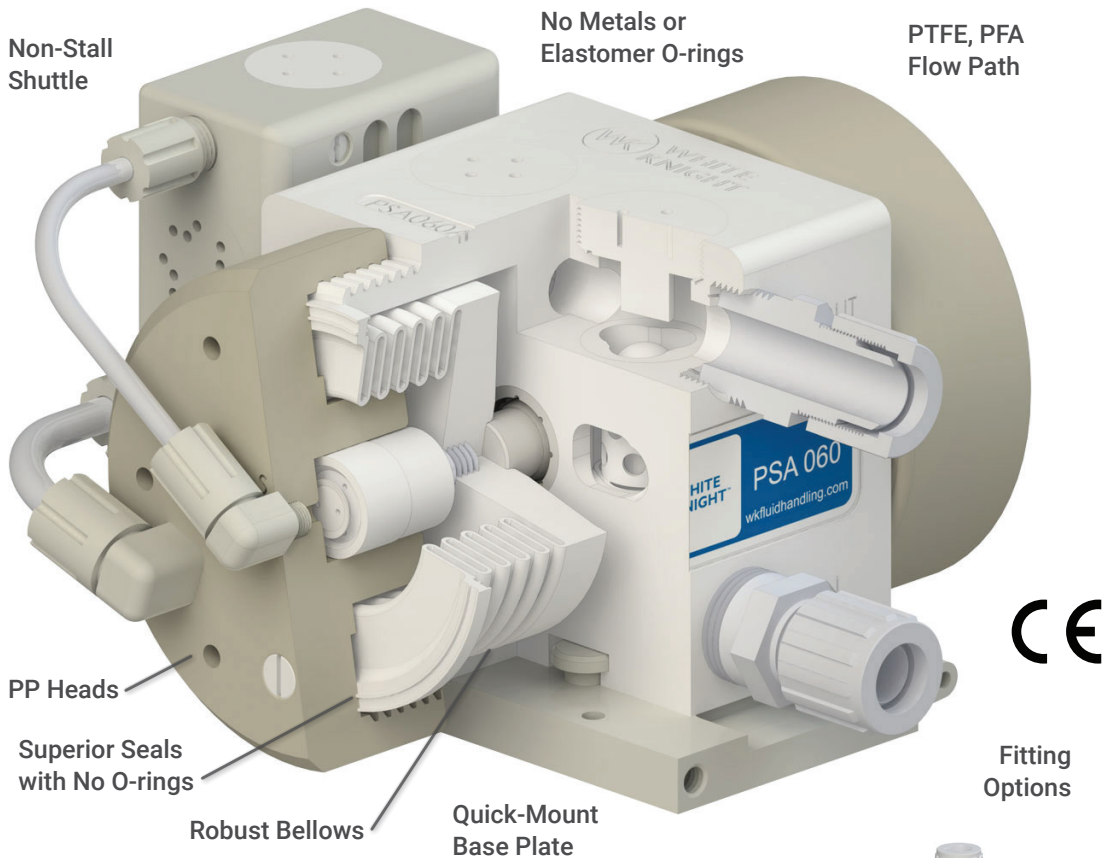

Features & Benefits

- Process-safe PTFE, PFA flow paths
- Contains no metals or elastomers
- Durable machined design with minimal parts
- Reliable, safe operation with leak-free seals and no O-rings
- On-board, non-stall shuttle saves space and eliminates resets
- Robust bellows allow for 7 Bar (100 psi) supply pressure
- Pneumatic Logic™ minimizes liquid pulsation and pump vibration
- Lubricant-free shifting eliminates potential contamination
- No electric motors, which generate heat
- Class 100 cleanroom assembly, testing, and packaging
- No preventative maintenance during two-year warranty



Industries

Semiconductor
LEDs & Electronics
Flat-Panel Displays
Photovoltaic / Solar
Aerospace

Applications

Chemical Delivery
Chemical Circulation
Chemical Processing
Chemical Reclaim
Bulk Transport
CMP Slurry

<https://wkfluidhandling.com/psa-series/>



Operation

Pneumatic Logic™ minimizes pulsation, vibration, and wear. It ensures correct spool placement at the end of each stroke and resets shuttle valves after shutdowns. It has no detents to fail or seals to fatigue.

See online animation.

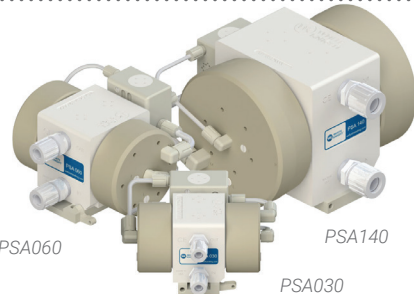
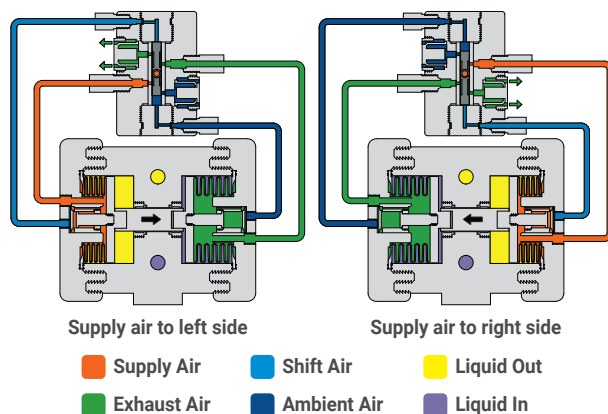

Configuration

PSA 060 - F 12 - LFO - SF0 - T P 08 -
 ① ② ③ ④ ⑤ ⑥ ⑦ ⑧ ⑨ ⑩ (optional)

- ① **Pump Model**
PSA = Standard
PSASD = Dry-run capable
- ② **Check ball material**
blank (default) = PTFE
F = PFA check balls
- ③ **Fitting Style**
F = Flaretek® compatible
P = Pillar S-300®
N = Female NPT (FNPT)
L = PrimeLock
T = Tube Out
W = Weldable
- ④ **Fitting Size**
04 = 1/4 in
06 = 3/8 in
08 = 1/2 in
12 = 3/4 in
16 = 1 in
20 = 1-1/4 in
24 = 1-1/2 in

- ⑤ **Leak Detection** (optional)
LF0 = 15 ft fiber optic cable, no amplifier
LF1 = 15 ft fiber optic cable, D10 amplifier
LF2 = 25 ft fiber optic cable, no amplifier
LF3 = 25 ft fiber optic cable, D10 amplifier
LC0 = 15 ft conductivity cable
LC1 = 25 ft conductivity cable

- ⑥ **Stroke Detection**
SF0 = Single probe, 15 ft fiber optic cable, no amplifier
SF1 = Single probe, 15 ft fiber optic cable, D10 amplifier
SF2 = Single probe, 25 ft fiber optic cable, no amplifier
SF3 = Single probe, 25 ft fiber optic cable, D10 amplifier
SP1 = Single Pressure Switch (NPN)
SP2 = Dual NPN Pressure Switch (each with two DP2)*
SP4 = Single PNP Pressure Switch
SP5 = Dual PNP Pressure Switch (each with two DP2)

⑦ Liquid Outlet Position

- F = Front straight liquid outlet
- T = Top straight liquid outlet

⑧ ⑨ Liquid Outlet Style and Size

Choices are same as ③ and ④ above

⑩ Shuttle

- blank (default) = PTFE
- VX0 = No shuttle, standard ports*
- VG1 = Gravity reset with remote exhaust
- VM0 = Mag detent with standard exhaust**
- VM1 = Mag detent with remote exhaust**

Define optional items only if desired. Define outlet fitting options (6-8) if they differ from inlet fitting options (2)(3).

All fittings are not available in all sizes, and all fittings are not compatible with all pump sizes. Call for details. Operating pumps in timer mode requires end-of-stroke detection to prevent over stroking. Operating a pump in timer mode without stroke detection voids the warranty.

*Comes without White Knight shuttle valve.

**Not available with PSA015 or PSA030

Contact White Knight for copy exact information.

Temperature Limitations

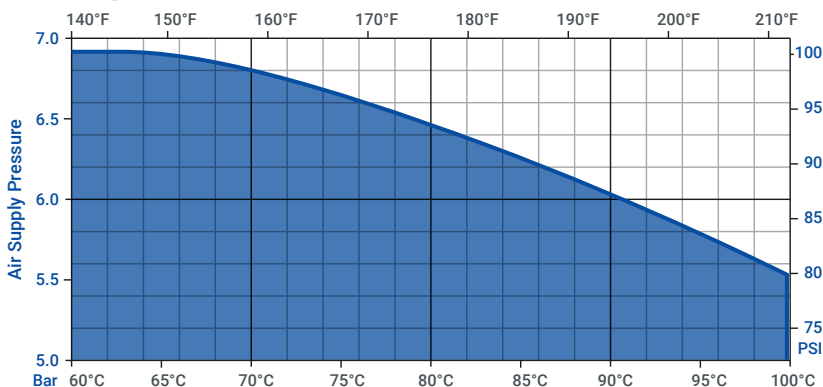

Specifications

Model	PSA015	PSA030	PSA060	PSA140
Max Flow Rate*	13.6 lpm (3.60 gpm)	24.7 lpm (6.53 gpm)	62.3 lpm (16.46 gpm)	123 lpm (32.5 gpm)
Displacement Per Cycle*	0.074 liters (0.019 gal)	0.074 liters (0.019 gal)	0.178 liters (0.047 gal)	0.500 liters (0.132 gal)
Cycles per min	≤ 216	≤ 333	≤ 348	≤ 273
Air Connection	1/4 in FNPT	1/4 in FNPT	1/4 in FNPT	3/8 in FNPT
Weight	3.3 kg (7.3 lb)	3.3 kg (7.3 lb)	4.7 kg (10.4 lb)	16.6 kg (36.6 lb)
Suction Lift*	≤ 3 m (10 ft)	≤ 3 m (10 ft)	≤ 3 m (10 ft)	≤ 3 m (10 ft)
Sound	Pressure**	74.00 dB(a) 79.90 dB(a)	73.11 dB(a) 82.50 dB(a)	81.98 dB(a) 91.60 dB(a)
	Power**	63.01 dB(a) 69.90 dB(a)	63.01 dB(a) 69.90 dB(a)	64.29 dB(a) 74.11 dB(a)

Stroke Detection	Fiber optic with or without D10 sensor, or solid state pressure switch (NPN or PNP)	Max Fluid Temperature	100°C (212°F)
Leak Detection	Fiber optic with or without sensor, or conductivity	Max Supply Air Pressure	7 Bar (100 psi)
Electronic Control	CPC, CPT, or custom. Call for details.	Min Startup Air Pressure	1.4 bar (20 psi)
		Fluid Path Materials	PTFE, PFA
		Non-Fluid Path Materials	PTFE, PFA, PP, Ceramic

* May vary by configuration and system. Suction lift diminishes over time. Recommended installation level less than 3 ft above source. To calculate displacement, divide flow rate by CPM.

** dB at 100 psi 50 CPM (top) and 100 psi max. CPM (bottom).

Sound levels measured in accordance with ISO9614-2:1997.

***Dry-run capable PSASD pumps require flooded suction, and may have a reduced warranty. Contact White Knight for details.

Performance

PSA030

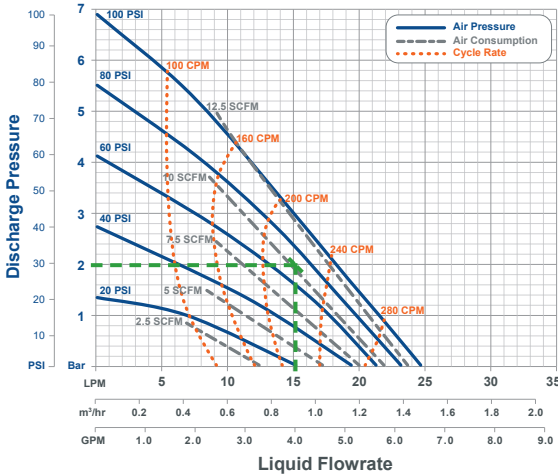

PSASD030

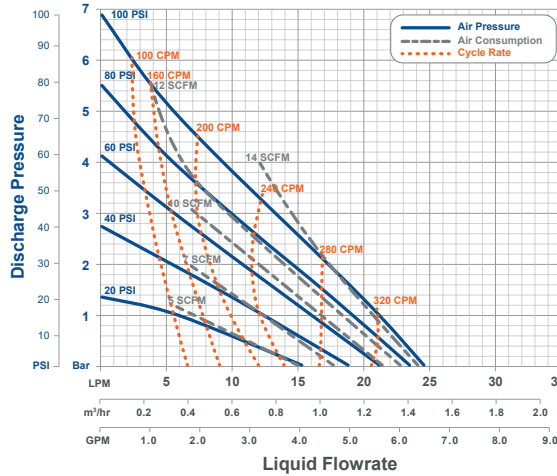

PSA060

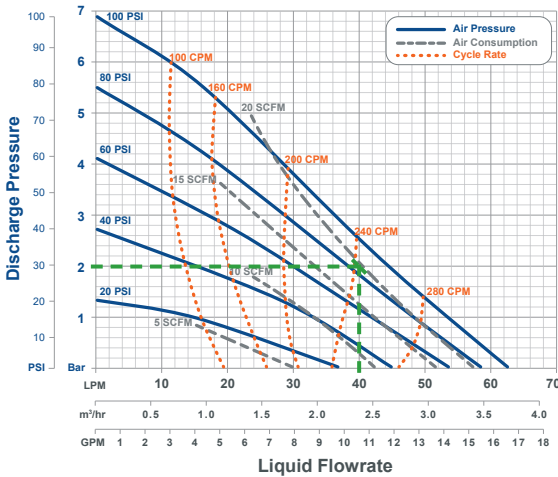

PSASD060

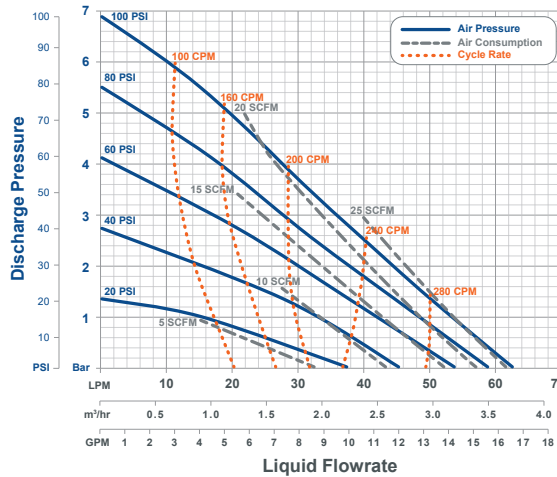

PSA140

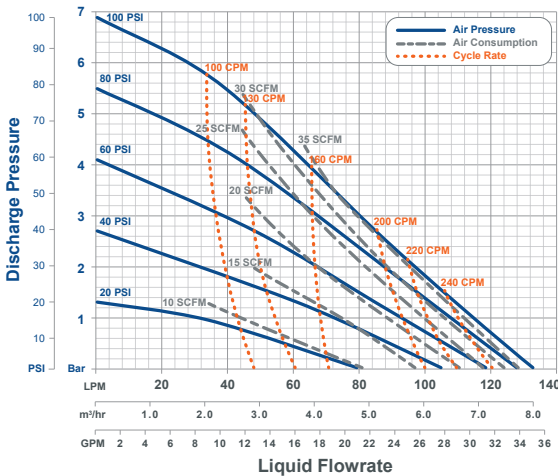

PSA015

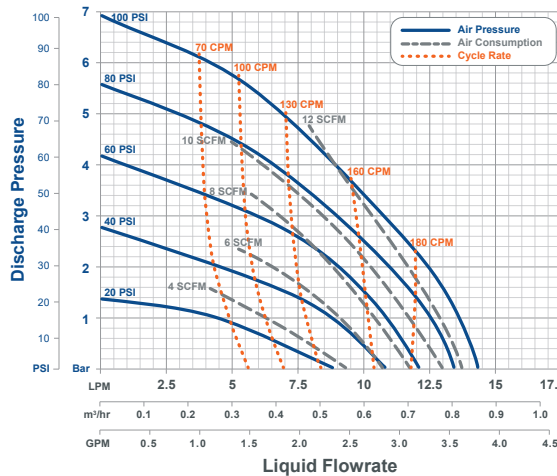

Reading Charts

Draw a horizontal line from your discharge pressure and a vertical line through your desired flow rate. At their intersection, estimate required air supply pressure, cycle rate and air consumption.

See green dashed lines in PSA030 and PSA060 charts for examples.

Example 1

At 2 Bar (30 psi) liquid discharge pressure and 70 psi supply pressure, PSA030 pumps provide 15 lpm (4 gpm) liquid flow rate. They would cycle at 220 CPM, and exhaust 10 SCFM of air.

Example 2

At 2 Bar (30 psi) liquid discharge pressure and 82 psi supply pressure, PSA060 pumps provide 40 lpm (10.6 gpm) flow rates. They would cycle at 240 CPM and exhaust 20 SCFM of air.

*Graph is for reference only. Performance was measured utilizing 1/2 in (3/8 in ID) air line and 1-1/4 in (1-1/8 in ID) liquid lines with 1 ft flooded suction. Performance may vary in your system.

Dimensions

mm (inches)

	PSA015	PSA030	PSA060	PSA140
A	234 (9.2)	234 (9.2)	270 (10.6)	361 (14.2)
B	214 (8.4)	214 (8.4)	259 (10.2)	345 (13.6)
C	121 (4.8)	121 (4.8)	154 (6.1)	233 (9.2)
D	∅105 (4.1)	∅105 (4.1)	∅140 (5.5)	∅222 (8.7)
E	57 (2.2)	57 (2.2)	79 (3.1)	138 (5.4)
F	66 (2.6)	66 (2.6)	75 (3.0)	75 (3.0)
G	100 (3.9)	100 (3.9)	127 (5.0)	206 (8.1)
H	8 (0.3)	8 (0.3)	8 (0.3)	8 (0.3)
I	32 (1.3)	32 (1.3)	37 (1.5)	53 (2.1)
J	31 (1.2)	31 (1.2)	46 (1.8)	47 (1.8)
K	51 (2.0)	51 (2.0)	51 (2.0)	51 (2.0)
L	11 (0.4)	11 (0.4)	10 (0.4)	11 (0.4)
M	62 (2.5)	62 (2.5)	91 (3.6)	94 (3.7)
N	25 (1.0)	25 (1.0)	19 (0.7)	57 (2.2)
O	111 (4.4)	111 (4.4)	135 (5.3)	215 (8.4)

Rigid baseplate available. Call for details.

<https://wkfluidhandling.com/psa-series/>

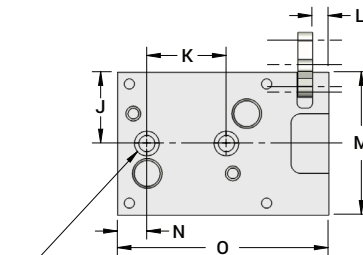
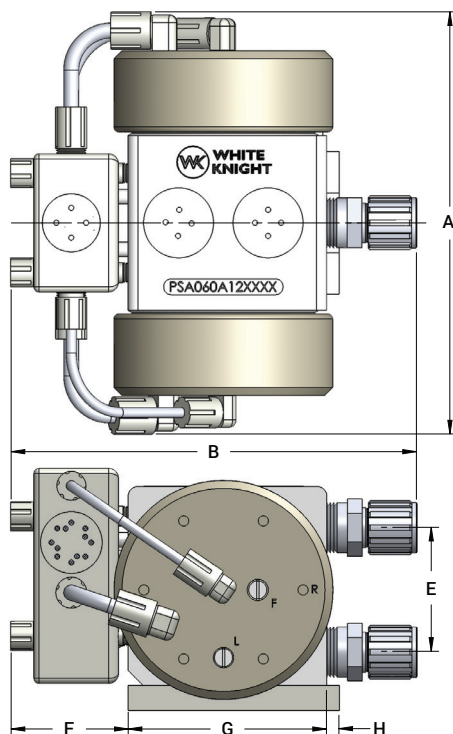

MOUNT WITH 2 EA. 3/8" (10 mm) SOCKET HEAD CAP SCREWS

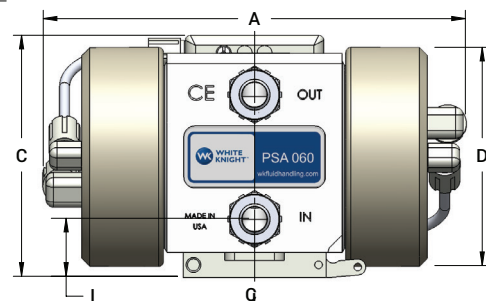

White Knight Accessories

Ultrapure Closed-Loop Systems

Automatically control flow or pressure with metal-free systems capable of 210°C, dead-head and suction lift!



Automatically maintain flow or pressure in ultrapure chemical process and delivery systems. Simplify process automation to save time and resources, improve yields and reduce cost.

<https://wkfluidhandling.com/closed-loop/>

- ⊙ Up to 210°C (410°F)
- ⊙ No metals or elastomers
- ⊙ No heat generation
- ⊙ No O-rings or lubrication
- ⊙ Suction lift & dead-head

Pulse Dampeners

Reduce pulsation in fluid systems to improve flow control, increase yields, protect fittings and pipes, and minimize downtime for repairs.

<https://wkfluidhandling.com/dampeners/>



Pressure Regulators

Control upstream or downstream pressure! A single back-pressure regulator equalizes upstream fluid pressure across multiple discharge outlets. Forward-pressure regulators control downstream pressure.

<https://wkfluidhandling.com/regulators/>



Cycle-Rate Translator

The CPT enables pump replacements in existing tools. It operates a White Knight pump at its optimal cycle rate and scales the operational cycle rate to that expected by the tool.

<https://wkfluidhandling.com/cpt/>