

Ultrapure Chemical Pumps with Proximity Sensors

Proximity switch-controlled pumps with PTFE, PFA flow paths for ultrapure chemicals. PXH Series pumps are capable of 145°C (293°F) fluid temperatures and 5.5 Bar (80 psi) air pressures. PXHSD models can run dry for more than one hour without pump damage.

Advanced Pump Technologies

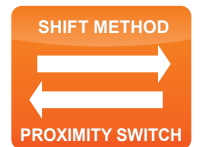
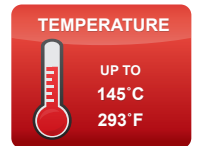
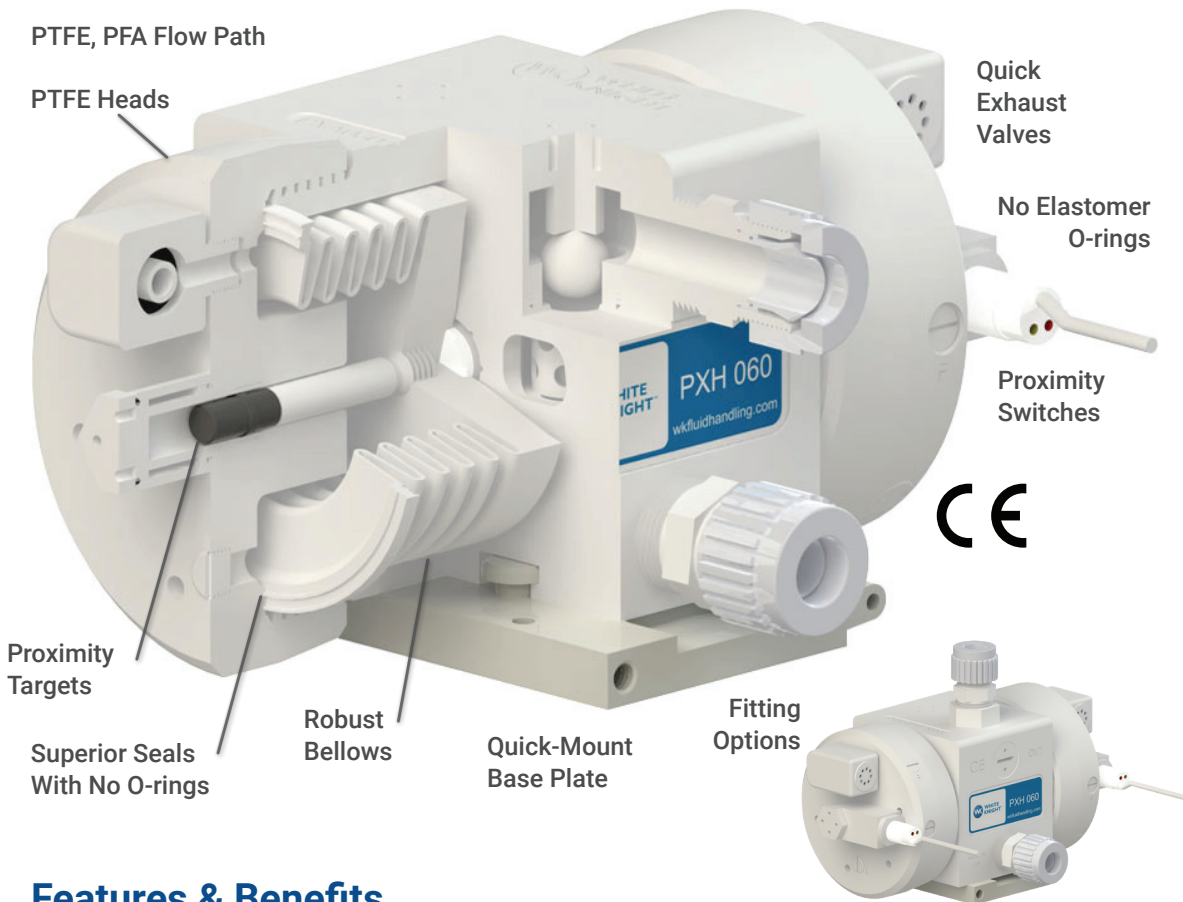

Features & Benefits

- Process-safe PTFE, PFA flow paths
- Proximity sensors provide optimal control
- Durable machined design with minimal parts
- Reliable, safe operation with leak-free seals and no O-rings
- PTFE pump heads, stainless steel proximity targets
- Robust bellows allow for 5.5 Bar (80 psi) supply pressure
- Lubricant-free shifting eliminates potential contamination
- No electric motors, which generate heat
- Class 100 cleanroom assembly, testing, and packaging
- No preventative maintenance during two-year warranty

**Not for use in solvents*

Easily Replace Pumps Using Proximity Sensors

CPT-1 cycle rate translator enables pump replacement in many tools. It eliminates the need for OEM tool reprogramming. It operates the pump at its optimal cycle rate and scales its signals for the tool to manage cycle rate errors alarms.



CPT-1

Industries

Semiconductor
LEDs & Electronics
Flat-Panel Displays
Photovoltaic / Solar
Aerospace

Applications

Chemical Delivery
Chemical Circulation
Chemical Processing
Chemical Reclaim
Bulk Transport
CMP Slurry

<https://wkfluidhandling.com/pxh-series/>



Operation

A solenoid valve and proximity switches monitor stroke timing to optimize for flow and durability.

See online animation.

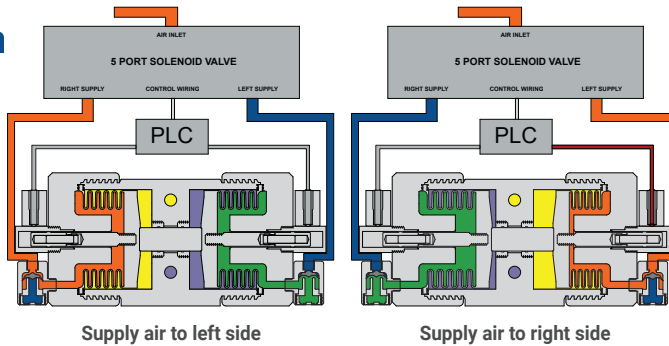

- Supply Air
- Ambient Air
- Liquid Out
- Exhaust Air
- Shift Signal
- Liquid In

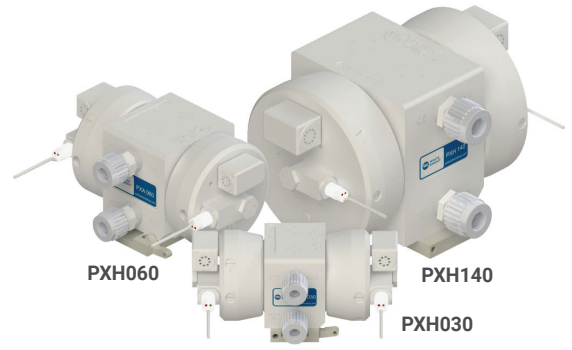

Temperature Limitations

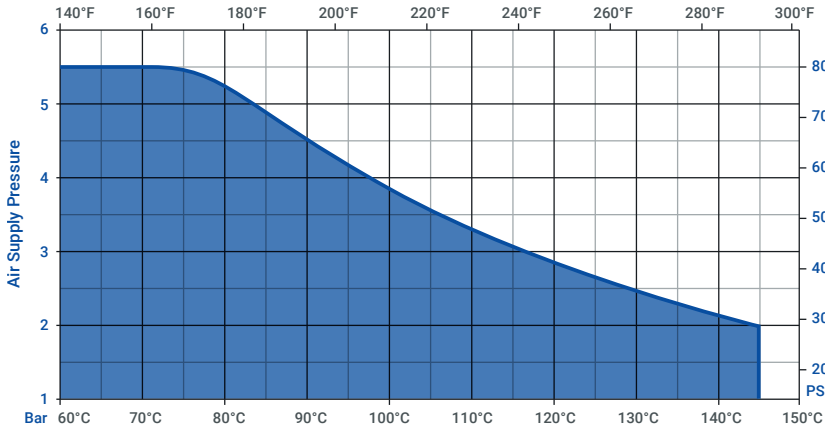

Specifications

Model	PXH030	PXH060	PXH140	
Max Flow Rate*	24.3 lpm (6.42 gpm)	63.8 lpm (16.85 gpm)	137.8 lpm (36.40 gpm)	
Displacement Per Cycle*	0.089 liters (0.024 gal)	0.216 liters (0.057 gal)	0.500 liters (0.132 gal)	
Cycles per min	≤ 390	≤ 366	≤ 247	
Air Connection	1/4 in FNPT	1/4 in FNPT	3/8 in FNPT	
Weight	3.6 kg (8.0 lb)	5.9 kg (13.0 lb)	17.2 kg (38.0 lb)	
Suction Lift*	≤ 1 m (3 ft)	≤ 1 m (3 ft)	≤ 1 m (3 ft)	
Sound	Pressure**	69.54 dB(a) 75.56 dB(a)	68.60 dB(a) 82.12 dB(a)	74.81 dB(a) 76.91 dB(a)
	Power**	58.44 dB(a) 64.49 dB(a)	60.66 dB(a) 73.35 dB(a)	72.30 dB(a) 73.45 dB(a)

Stroke Detection	Proximity stroke detection
Leak Detection	Fiber optic with or without sensor, or conductivity
Electronic Control	CPC, CPT, or custom. Call for details.

Max Fluid Temperature	145°C (293°F)
Max Supply Air Pressure	5.5 Bar (80 psi)
Min Startup Air Pressure	1.4 bar (20 psi)
Fluid Path Materials	PTFE, PFA
Non-Fluid Path Materials	PTFE, PFA, SS

* May vary by configuration and system. Suction lift diminishes over time. Recommended installation level less than 3 ft above source. To calculate displacement, divide flow rate by CPM.
 ** dB at 80 psi 50 CPM (top) and 80 psi max CPM (bottom). Sound levels measured in accordance with ISO9614-2:1997.
 ***Dry-run capable PXHSD pumps require flooded suction, and may have a reduced warranty. Contact White Knight for details.

Configuration

PXH 060 - F 12 - LF0 - SX1 - T P 08 - A -
 ① ② ③ ④ ⑤ ⑥ ⑦ ⑧ ⑨ ⑩ A (optional)

- ① **Pump Model**
PXH = Standard
PXHSD = Dry-run capable
- ② **Check ball material**
blank (default) = PTFE
F = PFA check balls
- ③ **Fitting Style**
F = Flaretek® compatible
T = Tube Out
W = Weldable
P = Pillar S-300®
N = Female NPT (FNPT)
- ④ **Fitting Size**
04 = 1/4 in
06 = 3/8 in
08 = 1/2 in
12 = 3/4 in
16 = 1 in
20 = 1-1/4 in
24 = 1-1/2 in
- ⑤ **Leak Detection** (optional)
LF0 = 15 ft fiber optic cable, no amplifier
LF1 = 15 ft fiber optic cable, D10 amplifier
LF2 = 25 ft fiber optic cable, no amplifier
LF3 = 25 ft fiber optic cable, D10 amplifier
LC0 = 15 ft conductivity cable
- ⑥ **Stroke Detection (*Required for operation)**
SX1 = 15 ft PNP normally open proximity switch
- ⑦ **Liquid Outlet Position**
F = Front straight liquid outlet
T = Top straight liquid outlet
- ⑧ ⑨ **Liquid Outlet Style and Size**
Choices are same as ③ and ④ above
- ⑩ **Quick Exhaust/Air Inlet**
A = 5/16 in NPT Adapter
- A **Revision level**
Contact White Knight for copy exact information.

Define optional items only if desired. Define outlet fitting options (6-8) if they differ from inlet fitting options (2)(3). All fittings are not available in all sizes, and all fittings are not compatible with all pump sizes. Call for details. Operating pump in timer mode requires end-of-stroke detection to prevent over stroking. Operating a pump in timer mode without stroke detection voids the warranty. Operating pump without quick exhaust valves voids warranty. Customers may use NPT adapter and supply their own QEVs.



Performance

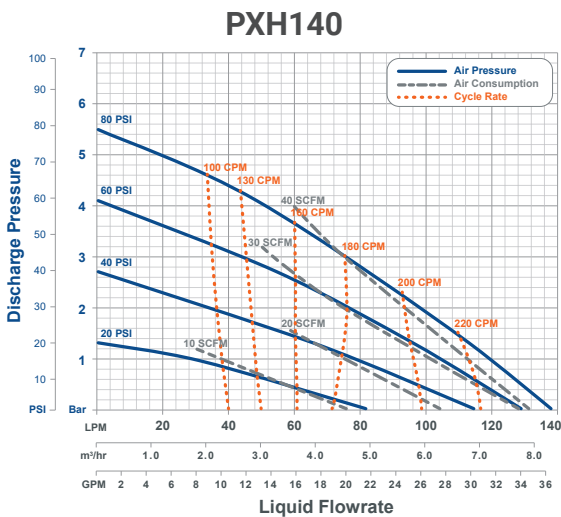
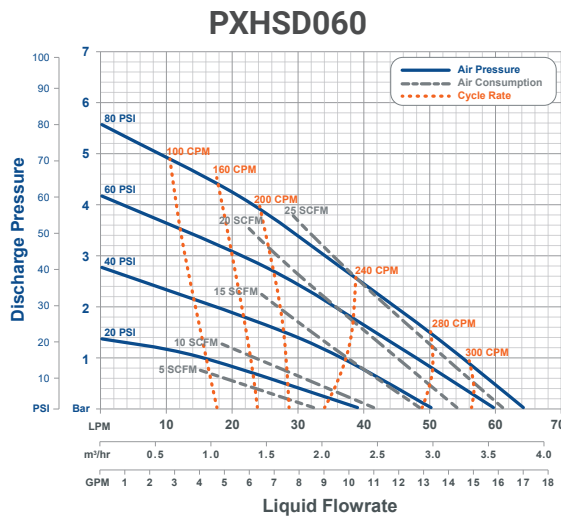
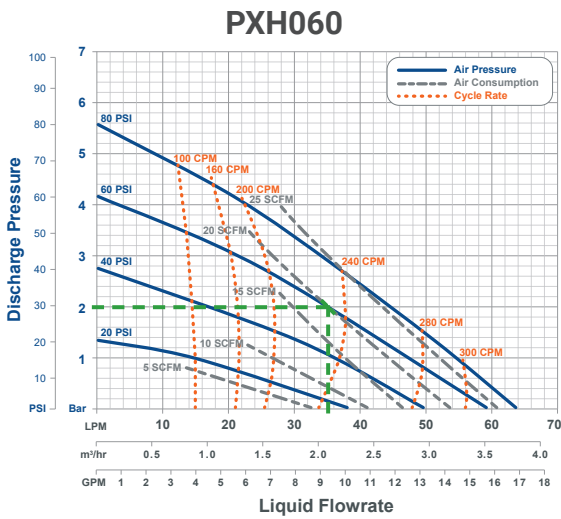
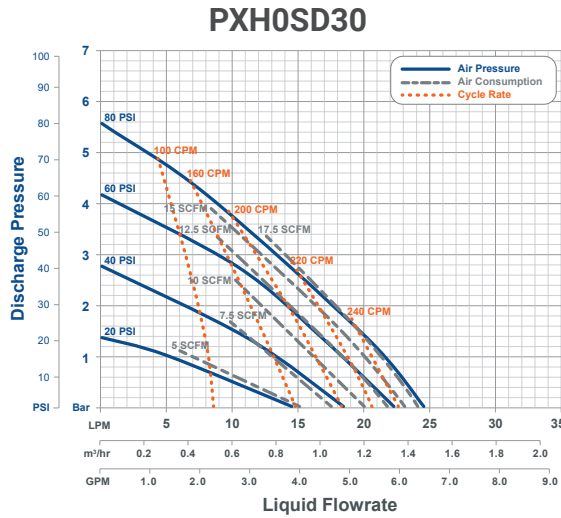
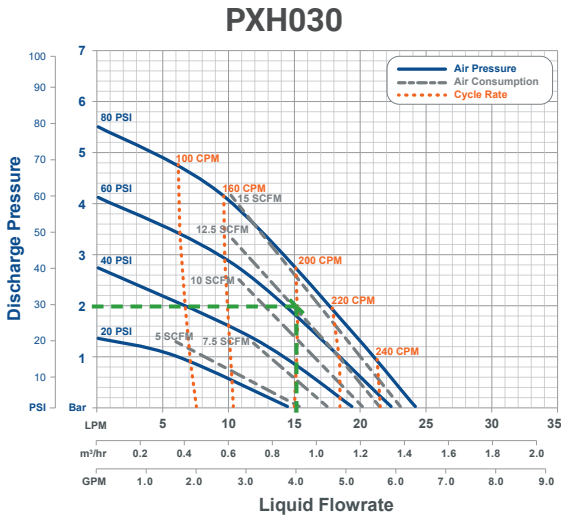

Reading Charts

Draw a horizontal line from your discharge pressure and a vertical line through your desired flow rate. At their intersection, estimate required air supply pressure, cycle rate and air consumption.

See green dashed lines in PXH030 and PXH060 charts for examples.

Example 1

At 2 Bar (30 psi) liquid discharge pressure and 60 psi supply pressure, PXH030 pumps provide 15 lpm (4 gpm) liquid flow rate. They would cycle at 200 CPM, and exhaust 12.5 SCFM.

Example 2

At 2 Bar (30 psi) liquid discharge pressure and 60 psi supply pressure, PXH060 pumps provide 35 lpm (9.3 gpm) flow rates. They would cycle at 230 CPM and exhaust 20 SCFM of air.

Improve Performance with Pulse Dampeners

In-line and top-mount dampeners reduce pulsation in fluid systems to improve flow control, increase batch yields, protect components, and minimize maintenance and downtime for repairs. DBH030 dampeners fit 30 and 60 lpm pumps. DBH060 dampeners fit 30, 60 and 140 lpm pumps. DBH140 dampeners fit 60 and 140 lpm pumps.

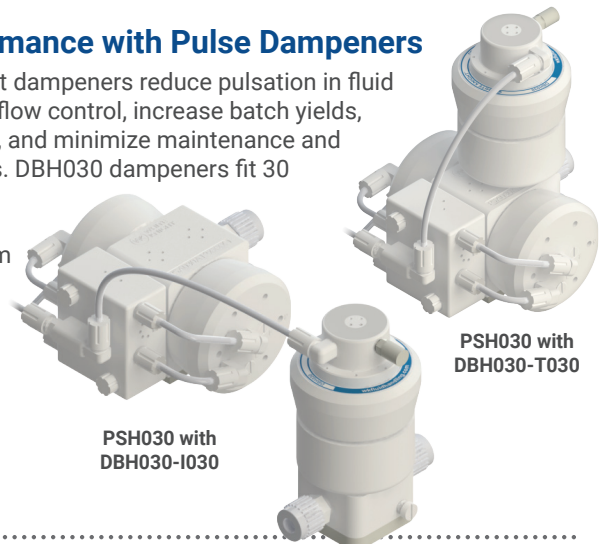

PSH030 with DBH030-1030

PSH030 with DBH030-T030

*Graph is for reference only. Performance was measured utilizing 1/2 in (3/8 in ID) air line and 1-1/4 in (1-1/8 in ID) liquid lines with 1 ft flooded suction. Performance may vary in your system.

Dimensions

mm (inches)

	PXH030	PXH060	PXH140
A	263 (10.4)	290 (11.4)	384 (15.1)
B	154 (6.1)	196 (7.7)	278 (11.0)
C	121 (4.8)	150 (5.9)	235 (9.2)
D	∅116 (4.6)	∅146 (5.8)	∅225 (8.9)
E	57 (2.2)	79 (3.1)	138 (5.4)
F	100 (3.9)	120 (4.7)	192 (7.6)
G	100 (3.9)	127 (5.0)	206 (8.1)
H	8 (0.3)	8 (0.3)	8 (0.3)
I	32 (1.3)	37 (1.5)	53 (2.1)
J	31 (1.2)	46 (1.8)	47 (1.8)
K	51 (2.0)	51 (2.0)	51 (2.0)
L	11 (0.4)	10 (0.4)	11 (0.4)
M	62 (2.5)	91 (3.6)	94 (3.7)
N	25 (1.0)	19 (0.7)	57 (2.2)
O	111 (4.4)	135 (5.3)	215 (8.4)

Rigid baseplate available. Call for details.

<https://wkfluidhandling.com/pxh/>

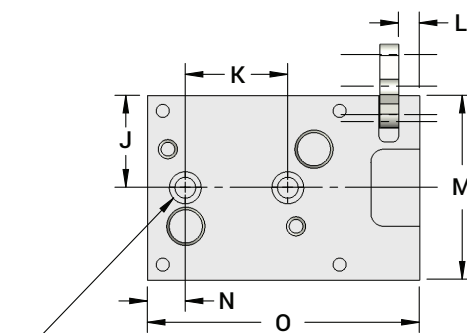
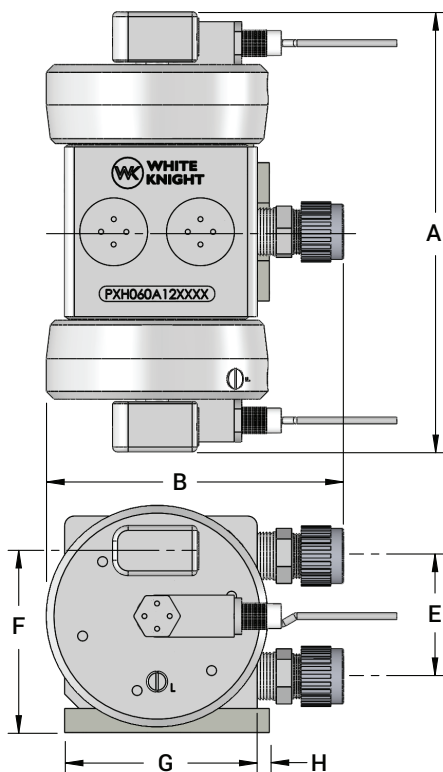

MOUNT WITH 2 EA. 3/8" (10 mm) SOCKET HEAD CAP SCREWS

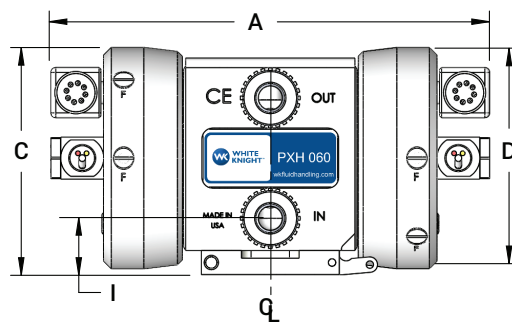

White Knight Accessories

Ultrapure Closed-Loop Systems

Automatically control flow or pressure with metal-free systems capable of 210°C, dead-head and suction lift!



Automatically maintain flow or pressure in ultrapure chemical process and delivery systems. Simplify process automation to save time and resources, improve yields and reduce cost.

<https://wkfluidhandling.com/closed-loop/>

- ⦿ Up to 210°C (410°F)
- ⦿ No metals or elastomers
- ⦿ No heat generation
- ⦿ No O-rings or lubrication
- ⦿ Suction lift & dead-head

Pulse Dampeners

Reduce pulsation in fluid systems to improve flow control, increase yields, protect fittings and pipes, and minimize downtime for repairs.

<https://wkfluidhandling.com/dampeners/>



Pressure Regulators

Control upstream or downstream pressure! A single back-pressure regulator equalizes upstream fluid pressure across multiple discharge outlets. Forward-pressure regulators control downstream pressure.

<https://wkfluidhandling.com/regulators/>



Cycle-Rate Translator

The CPT enables pump replacements in existing tools. It operates a White Knight pump at its optimal cycle rate and scales the operational cycle rate to that expected by the tool.

<https://wkfluidhandling.com/cpt/>